

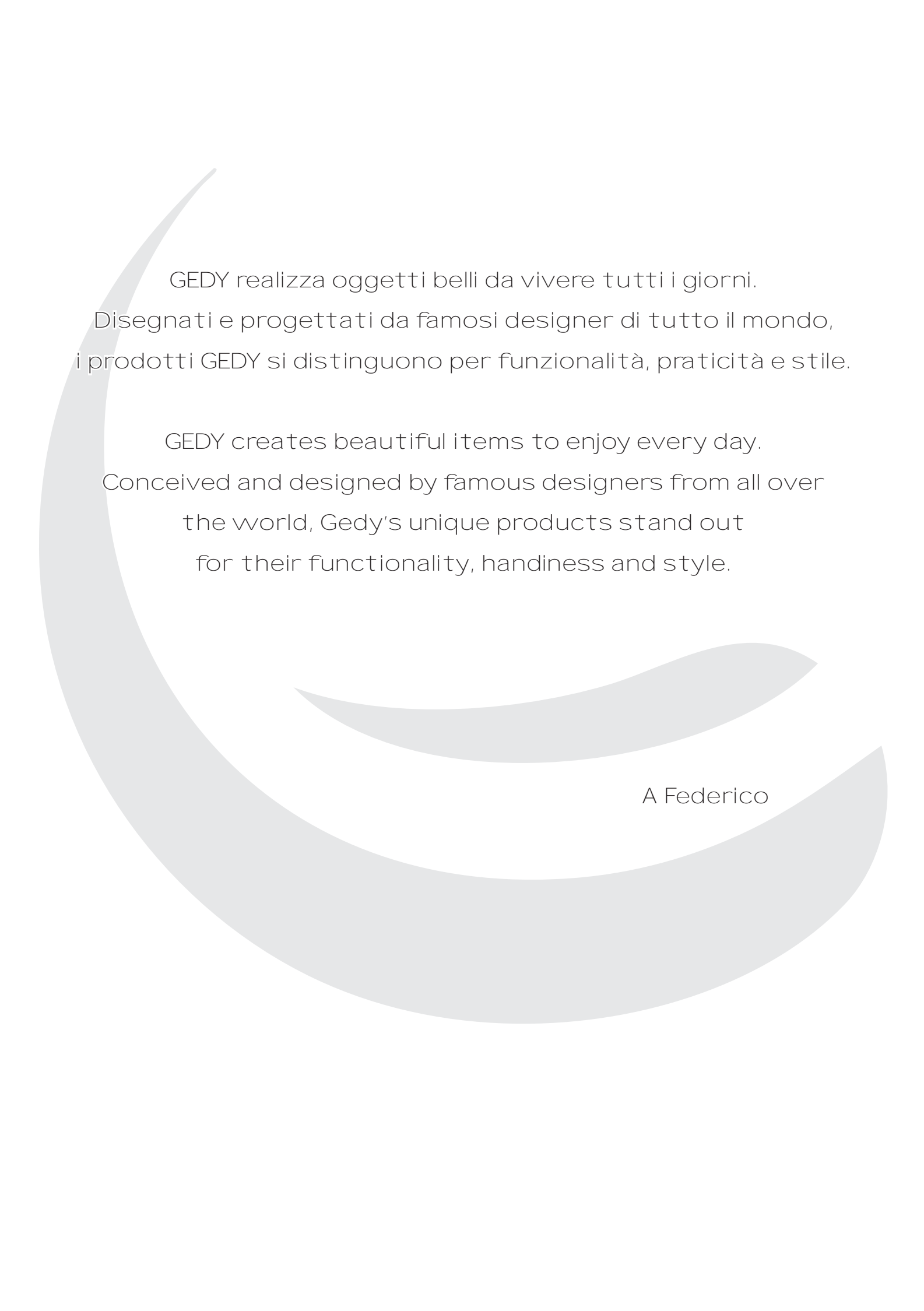

catalogo - catalogue

Katalog - catálogo - каталог



GEDY realizza oggetti belli da vivere tutti i giorni.
Disegnati e progettati da famosi designer di tutto il mondo,
i prodotti GEDY si distinguono per funzionalità, praticità e stile.

GEDY creates beautiful items to enjoy every day.
Conceived and designed by famous designers from all over
the world, Gedy's unique products stand out
for their functionality, handiness and style.

A Federico



Indice generale

TOP DESIGN pagina 3

RETAIL pagina 111

GEDY pagina 185

IDROTERAPIA pagina 481

CONTRACT pagina 563

La semplicità portata all'estremo
diventa eleganza.

Simplicity, carried to an extreme,
becomes elegance.

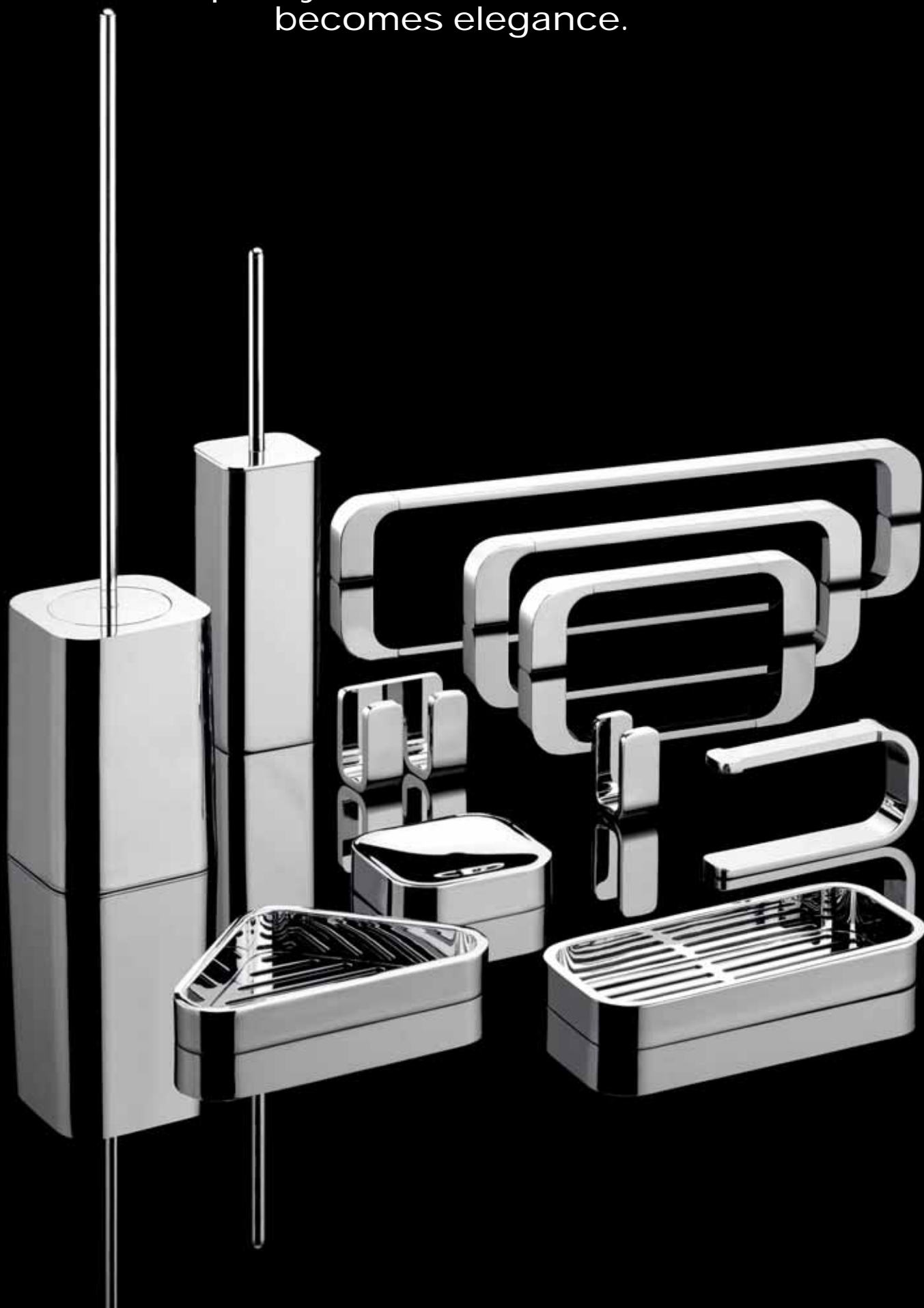



Indice

TOP DESIGN

wall fittings

serie da muro

G•AZZORRE pagina 22

G•BRIDGE pagina 62

G•CANARIE pagina 32

G•DEMETRA pagina 72

G•ELBA pagina 14

G•GEA pagina 78

G•LANZAROTE pagina 6

G•LOUNGE pagina 50

G•MALDIVE pagina 82

G•OUTLINE pagina 42

G•SISSI pagina 66

magnifying
mirrors
and lighting

specchi ingranditori e illuminazione

pagina 86

decorative
accessories

complementi d'arredo

pagina 92

shower and bathtub
accessories

accessori zona doccia

pagina 102



TOP DESIGN



G•LANZAROTE







A310

Portaspazzolini
Toothbrush holder

7,8 x 9,5 x 12 cm

Porte brosse à dents
Zahnbürstenhalter
Portacepillos
Стакан для зубных щёток

A311

Portasapone
Soap holder

11 x 11 x 3 cm

Porte savon
Seifenschale
Jabonera
Мыльница



A381

Dosasapone
Soap dispenser

8,5 x 9,5 x 18,2 cm

Distributeur de savon
Seifenspender
Dosificador de jabón
Диспенсер жидкого мыла

G•LANZAROTE

13 Cromato
Chromed

Realizzata in ottone e Cromall® con contenitori in vetro satinato - Made of brass and Cromall® with frosted glass containers - Réalisée en laiton et Cromall® avec boîtiers en verre satiné - Hergestellt aus Messing und Cromall® mit Behältern aus satiniertem Glas - Realizada en latón y Cromall® con contenedores en cristal satinado - Изготовлено из латуни и Cromall® с ёмкостями из матового стекла



A321-30
Portasalviette
Towel holder
32,8 x 6 x 1,5 cm

Porte serviette
Handtuchhalter
Toallero
Полотенцедержатель



A321-45
Portasalviette
Towel holder
48 x 6 x 1,5 cm

Porte serviette
Handtuchhalter
Toallero
Полотенцедержатель

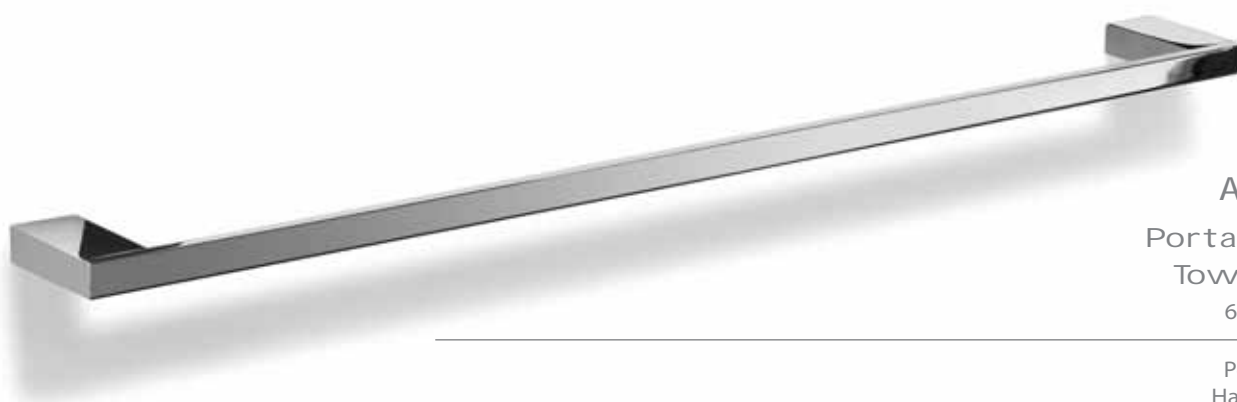

A321-60
Portasalviette
Towel holder
63 x 6 x 1,5 cm

Porte serviette
Handtuchhalter
Toallero
Полотенцедержатель



A323

Portasalvietta a snodo
Jointed towel holder

4,5 x 37,5 x 3 cm

Porte serviette réglable
Handtuchhalter schwenkbar
Toallero articulado
Полотенцедержатель
на шарнирах

A324

Portarotolo
Toilet paper holder
17 x 6 x 2,2 cm

Porte rouleau
Papierrollenhalter
Portarrollos
Бумагодержатель





A329

Portarotolo doppio
Double paper holder

31 x 6 x 2,2 cm

Porte rouleau double
Papierrollenhalter doppelt
Portarrollos doble
Двойной бумагодержатель



A325

Portarotolo coperto
Paper holder with cover

17 x 11,5 x 6 cm

Porte rouleau avec couvercle
Papierrollenhalter mit Deckel
Portarrollos con tapa
Бумагодержатель с крышкой





A370
 Portasalviette ad anello
 Towel ring
 22 x 6 x 11 cm

Anneau porte serviette
 Handtuchring
 Toallero argolla
 Полотенцедержатель "кольцо"

A326
 Appendiabiti
 Hook
 2 x 4 x 6 cm

Crochet
 Haken
 Percha
 Крючок





A333-O3

Scopino WC da muro con manico telescopico
Wall toilet brush holder with telescopic handle

10 x 12 x 38 cm

Porte-brosse mural WC à mur avec manche télescopique
Wand-Toilettenbürste mit ausziehbarem Stiel
Escobillero de pared con mango telescópico
Настенный туалетный ершик с телескопической ручкой

G•ELBA



FISSABILE ANCHE CON COLLA (VENDUTA A PARTE)

Can be fixed with glue (sold separately)

Peut être fixé avec de la colle

(vendu séparément)

Kann mit Kleber fixiert werden

(separat erhältlich)

Может быть закреплен клеем

(продается отдельно)







AO10

Portaspazzolini
Tooth brush holder

7 x 10,5 x 10 cm

Porte brosse à dents
Zahnbürstenhalter
Portacepillos
Стакан для зубных щёток

AO11

Portasapone
Soap holder

12 x 13 x 4,5 cm

Porte savon
Seifenschale
Jabonera
Мыльница



AO81

Dosasapone
Soap dispenser

9,5 x 10,5 x 16 cm

Distributeur de savon
Seifenspender
Dosificador de jabón
ДиДиспенсер для жидкого мыла

G•ELBA

13 Cromato
Chromed

Realizzata in ottone e alluminio con contenitori in vetro satinato - Made of brass and aluminium with frosted glass containers
Réalisée en laiton et aluminium avec boîtiers en verre satiné - Hergestellt aus Messing und Aluminium mit Behältern aus satiniertem Glas
Realizada en latón y aluminio con contenedores en cristal satinado - Изготовлено из латуни и алюминия с ёмкостями из матового стекла



AO21-30

Portasalviette
Towel holder
34,4 X 6,5 X 4,4 cm

Porte serviette
Handtuchhalter
Toallero
Полотенцедержатель



AO21-45

Portasalviette
Towel holder
49,4 X 6,5 X 4,4 cm

Porte serviette
Handtuchhalter
Toallero
Полотенцедержатель



AO21-60

Portasalviette
Towel holder
64,4 X 6,5 X 4,4 cm

Porte serviette
Handtuchhalter
Toallero
Полотенцедержатель



AO22

Portasalviette fisso a 2 braccia
Fixed towel rack with two rails

11 x 40 x 3 cm

Porte-serviette fixe 2 barres
Handtuchhalter, fest, mit 2 Armen
Toallero fijo de 2 brazos
Полотенцедержатель
(2 рожка)

AO26

Appendiabiti

Hook

4,4 x 5 x 5,4 cm

Crochet
Haken
Percha
Крючок



120
kg

AO21-28

Maniglione
Grab bar

29,5 x 6,5 x 2,5 cm

Grab bar
Barre d'appui
Wannengriff
Asidero
Поручень

AO70

Portasalviette ad anello

Towel ring

22 x 5 x 12,8 cm

Anneau porte serviette
Handtuchring
Toallero argolla
Полотенцедержатель "кольцо"

**AO24**Portarotolo
Toilet paper holder

16,2 x 6,5 x 4,5 cm

Porte rouleau
Papierrollenhalter
Portarrollos
Бумагодержатель



AO33

Scopino WC con ciuffo in setole
Toilet brush holder with bristle brush

9,6 x 9,6 x 39,5 cm

Porte-brosse balai avec brosse en nylon
WC-Bürstengarnitur mit Borsten-Aufsatz
Escobillero con escobilla de nylon
Туалетный ёршик с нейлоновой щетиной

A033-03

Scopino WC da muro con ciuffo in setole
Wall toilet brush holder with bristle brush

9,7 x 13 x 39 cm

Porte-brosse balai à mur avec brosse en nylon
WC-Bürstengarnitur mit Borsten-Aufsatz mit Wandhalterung
Escobillero de pared con escobilla de nylon
Туалетный ёршик с нейлоновой щетиной



1161

Kit Placca incollo

(2 placche + 1 tubo colla 3 ml + biadesivo)

2 wall plates, glue tube and double-sided adhesive tape for glue fixing
(excluding A021-28/A022)

2 plaque murale, colle et biadhésif

pour fixation avec colle (à l'exclusion de A021-28/A022)

Packung mit 1 Wandplatte, Klebstofftube

und Klebebänder für Klebmontage (außer A021-28/A022)

Kit de fijación a la pared, tubo de cola 3 ml

y cintas adhesivas para fijación sin taladro (excepto A021-28/A022)

1 Комплект для приклеивания (накладка + 1 тубик с клеем
+двусторонняя клейкая лента)

(исключая A021-28/A022)



G•AZZORRE







A110

Portaspazzolini
Toothbrush holder

8,3 x 10 x 11,5 cm

Porte brosse à dents
Zahnbürstenhalter
Portacepillos
Стакан для зубных щёток

A111

Portasapone
Soap holder

11 x 11,6 x 4,1 cm

Porte savon
Seifenschale
Jabonera
Мыльница



A181

Dosasapone
Soap dispenser

10 x 10 x 17,6 cm

Distributeur de savon
Seifenspender
Dosificador de jabón
Дозатор для жидкого мыла

G•AZZORRE

13 Cromato
Chromed

Realizzata in alluminio, ottone e Cromall® con contenitori in vetro satinato - Made of aluminium, brass and Cromall® with frosted glass containers - Réalisée en aluminium, laiton et Cromall® avec boîtiers en verre satiné - Hergestellt aus Aluminium, Messing und Cromall® mit Behältern aus satiniertem Glas - Realizada en aluminio, latón y Cromall® con contenedores en cristal satinado - Изготовлено из алюминия, латуни и Cromall® с ёмкостями из матового стекла



A121 - 30

Portasalviette
Towel holder

34,5 x 5,7 x 2,4 cm

Porte serviette
Handtuchhalter
Toallero
Полотенцедержатель



A121 - 45

Portasalviette
Towel holder

49,5 x 5,7 x 2,4 cm

Porte serviette
Handtuchhalter
Toallero
Полотенцедержатель

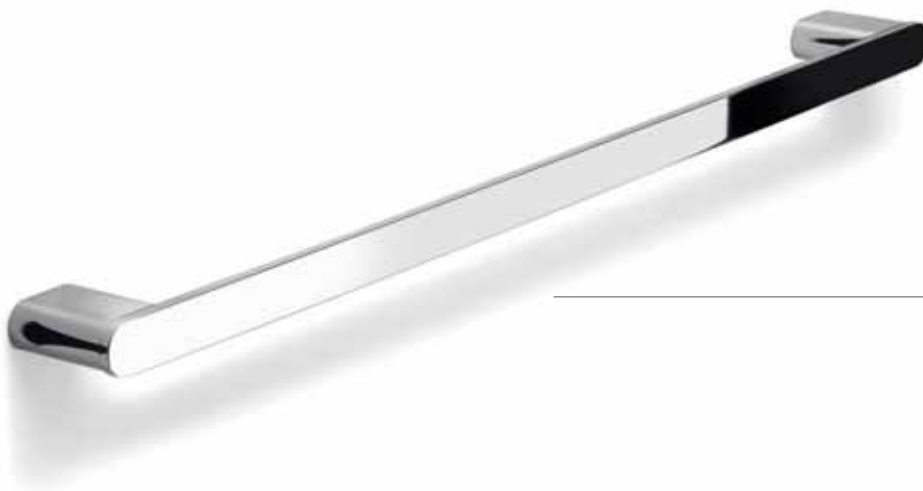

A121 - 60

Portasalviette
Towel holder

64 x 5,7 x 2,4 cm

Porte serviette
Handtuchhalter
Toallero
Полотенцедержатель

A123

Portasalviette a snodo
Jointed towel holder

4 x 38 x 3,2 cm

Porte serviette réglable
Handtuchhalter schwenkbar
Toallero articulado
Полотенцедержатель на шарнирах



A126

Appendiabiti doppio
Double hook

7,2 x 3 x 3 cm

Crochet double
Haken doppelt
Percha doble
Двойной крючок



A170

Portasalviette ad anello

Towel ring

21 x 10 x 2,5 cm

Anneau porte serviette
Handtuchring
Toallero argolla
Полотенцедержатель "кольцо"



A125

Portarotolo coperto

Toilet paper holder with cover

13,5 x 3 x 12,5 cm

Porte rouleau avec couvercle
Papierrollenhalter mit Deckel
Portarrollos con tapa
Бумагодержатель с крышкой



A124

Portarotolo

Toilet paper holder

18 x 5,5 x 3 cm

Porte rouleau
Papierrollenhalter
Portarrollos
Бумагодержатель



A147

Portasalviette attrezzabile
(accessori venduti separatamente)

Towel rail, with accessories
(accessories supplied separately)

46,6 x 10,2 x 2,5 cm

Porte-serviette accessorisable
Ausrüstbarer Handtuchhalter
Toallero equipable
Полотенцедержатель
горизонтальный или вертикальный







A151

Portasapone per portasalviette
attrezzabile A147
Soap dish accessory for towel rail A147

18 x 8,3 x 1,75 cm

Porte-savon pour porte-serviette accessoirisable A147
Seifenschale für ausrüstbaren Handtuchhalter A147
Jabonera para toallero equipable A147
Мыльница для полотенцедержателя A147

A155

Dosasapone per portasalviette
attrezzabile A147
Soap dispenser accessory for towel rail A147

Ø 8,3 x 17 cm

Distributeur de savon pour porte-serviette accessoirisable A147
Seifendosierer für ausrüstbaren Handtuchhalter A147
Dosificador jabón para toallero equipable A147
Дозатор мыла для полотенцедержателя A147



A198

Bicchiere per portasalviette attrezzabile A147
Glass accessory for towel rail A147

Ø 8,1 x 11,5 cm

Verre pour porte-serviette accessoirisable A147
Glas für ausrüstbaren Handtuchhalter A147
Vaso para toallero equipable A147
Стакан для Полотенцедержателя A147



A133-O3

Scopino WC da muro con manico telescopico
e ciuffo in setole

Toilet brush holder with telescopic handle
and bristle brush

9,8 x 11,9 x 43 cm

Porte-brosse WC à manche télescopique et brosse en nylon
Toilettenbürste mit ausziehbarem Stiel und mit Borsten-Aufsatz
Escobillero de pared con mango telescópico y escobilla de nylon
Настенный туалетный ершик с телескопической
ручкой с нейлоновой щетиной



G•CANARIE







A210

Portaspazzolini
Toothbrush holder

7,2 x 10 x 12 cm

Porte brosse à dents
Zahnbürstenhalter
Portacepillos
Стакан для зубных щёток

A211

Portasapone
Soap holder

11 x 11,5 x 4,5 cm

Porte savon
Seifenschale
Jabonera
Мыльница



A281

Dosasapone
Soap dispenser

9 x 10 x 18,5 cm

Distributeur de savon
Seifenspender
Dosificador de jabón
Дозатор для жидкого мыла

G•CANARIE

13 Cromato
Chromed

Realizzata in ottone e Cromall® con contenitori in vetro satinato - Made of brass and Cromall® with frosted glass containers
Réalisée en laiton et Cromall® avec boîtiers en verre satiné - Hergestellt aus Messing und Cromall® mit Behältern aus satiniertem Glas
Realizada en latón y Cromall® con contenedores en cristal satinado - Изготовлено из латуни и Cromall® с ёмкостями из матового стекла



A221-30

Portasalviette

Towel holder

35,4 x 7,2 x 2,2 cm

Porte serviette

Handtuchhalter

Toallero

Полотенцедержатель



A221-45

Portasalviette

Towel holder

50,5 x 7,2 x 2,2 cm

Porte serviette

Handtuchhalter

Toallero

Полотенцедержатель



A221-60

Portasalviette

Towel holder

65,5 x 7,2 x 2,2 cm

Porte serviette

Handtuchhalter

Toallero

Полотенцедержатель



A223

Portasalviette a snodo
Jointed towel holder

6 x 36,5 x 2 cm

Porte serviette réglable
Handtuchhalter schwenkbar
Toallero articulado
Полотенцедержатель на шарнирах



A270

Portasalviette ad anello
Towel ring

20 x 3,5 x 10 cm

Anneau porte serviette
Handtuchring
Toallero argolla
Полотенцедержатель "кольцо"

A224

Portarotolo
Toilet paper holder
19 x 7,2 x 2 cm

Porte rouleau
Papierrollenhalter
Portarrollos
Бумагодержатель

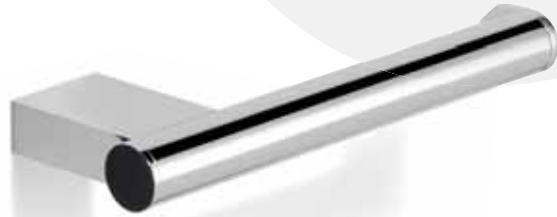
**A224-O2**

Portarotolo di riserva
Spare toilet paper holder
2 x 3 x 13 cm

Porte rouleau de reserve
Ersatzpapierrollenhalter
Portarrollos de reserva
Держатель запасного рулона

A229

Portarotolo doppio
Double toilet paper holder
29,7 x 7 x 2 cm

Porte rouleau double
Papierrollenhalter doppelt
Portarrollos doble
Двойной бумагодержатель

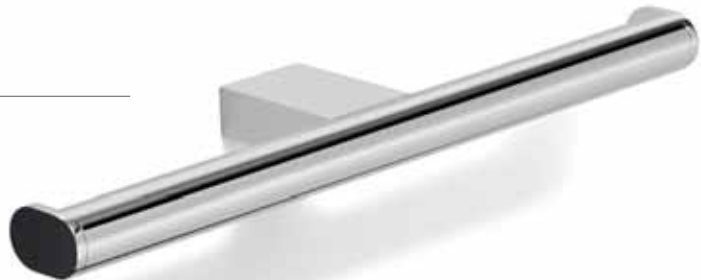



A225

Portarotolo coperto
Toilet paper holder with cover

13,3 x 3,5 x 12 cm

Porte rouleau avec couvercle
Papierrollenhalter mit Deckel
Portarrollos con tapa
Бумагодержатель с крышкой

A225-01

Portarotolo coperto
Toilet paper holder with cover

13 x 10,5 x 13 cm

Porte rouleau avec couvercle
Papierrollenhalter mit Deckel
Portarrollos con tapa
Бумагодержатель с крышкой



A227

Appendiabiti
Hook

ø 1,9 x 3,4 cm

Crochet
Haken
Percha
Крючок



A226

Appendiabiti doppio
Double hook

7 x 3,5 x 1,8 cm

Crochet double
Haken doppelt
Percha doble
Двойной крючок

A228

Appendiabiti multiplo
Multiple hook

17,2 x 3,5 x 1,8 cm

Crochet quatre têtes
Haken vierfach
Percha cuádruple
Мультикрючок

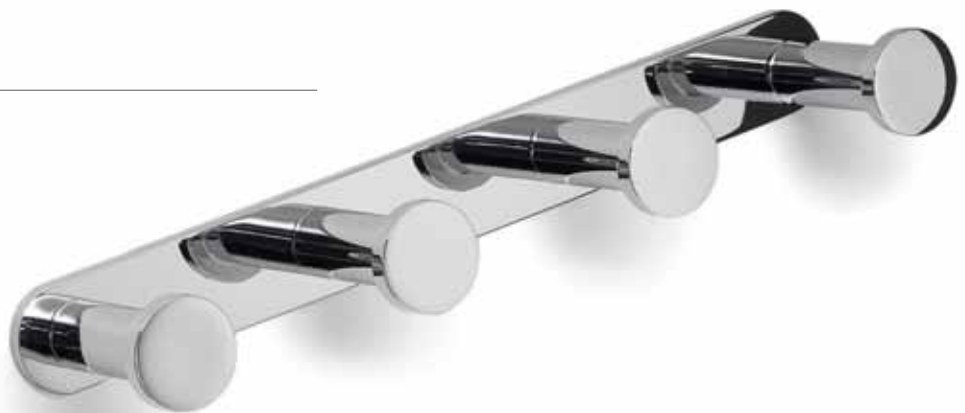



A221-28

Maniglione cm. 30

Grab bar cm. 30

30,5 x 7,5 x 2,5 cm

Barre d'appui cm 30

Wannengriff cm. 30

Asidero cm. 30

Поручень 30 см

A222

Maniglione 135°

Grab bar 135°

37,4 x 7,5 x 17,3 cm



Barre d'appui 135°

Wannengriff 135°

Asidero 135°

Поручень 135°



A235

Mensola portasalviette

Shelf for towels

62 x 25 x 14,5 cm

Étagère porte serviettes

Handtuchablage

Estante para toallas

Держатель полотенец



A233-O3

Scopino WC da muro con manico telescopico e ciuffo in setole
Toilet brush holder with telescopic handle and bristle brush

10 x 12 x 47 cm

Porte-brosse WC mural WC à mur à manche télescopique et brosse en nylon
WC-Bürste mit ausziehbarem Stiel und mit Borsten-Aufsatz mit Wandhalterung
Escobillero de pared con mango telescópico y escobilla de nylon
Настенный туалетный ершик с телескопической ручкой с нейлоновой щетиной



A233

Scopino WC con manico telescopico e ciuffo in setole
Toilet brush holder with telescopic handle and bristle brush

ø10 x 47 cm

Porte-brosse WC à manche télescopique et brosse en nylon
Toilettenbürste mit ausziehbarem Stiel und mit Borsten-Aufsatz
Escobillero con mango telescópico y escobilla de nylon
Настенный туалетный ершик с телескопической ручкой и нейлоновой щетиной

acciaio inox - stainless steel - acier inoxydable
Edelstahl - acero inox - нержавеющей сталь



G•OUTLINE

design
Simone Micheli







3212

Portasapone inamovibile

Soap holder

12,1 x 11 x 3 cm

Porte savon
Seifenschale
Jabonera
Несъемная мыльница

3218

Portaoggetti per doccia

Shower tray

24,1 x 11 x 3 cm

Porte-objets pour douche
Seifenhalter für die Dusche
Portaobjetos para ducha
Полочка для душа



3283

Portaoggetti per doccia

Shower tray

17 x 17 x 3 cm

Porte-objets pour douche
Seifenhalter für die Dusche
Portaobjetos para ducha
Полочка для душа



G•OUTLINE design Simone Micheli

13 Cromato
Chromed

NEW
22 Bianco
White

NEW
14 Nero matt
Matt black

Realizzata in ottone, acciaio inox e Cromall® - Made of brass, stainless steel and Cromall® - Réalisée en laiton, acier inoxydable et Cromall® - Hergestellt aus Messing, Edelstahl und Cromall® - Realizada en latón, acero inox y Cromall® - Изготовлено из латуни, нержавеющей стали и Cromall®



3221 / 25
 Portasalviette/maniglione di sicurezza
 Towel holder/grab bar
 25,1 x 7 x 3 cm

Porte serviette/barre d'appui
 Handtuchhalter/Wannengriff
 Toallero/asidero
 Полотенцедержатель/поручень



3221 / 35
 Portasalviette/maniglione di sicurezza
 Towel holder/grab bar
 35,1 x 7 x 3 cm

Porte serviette/barre d'appui
 Handtuchhalter/Wannengriff
 Toallero/asidero
 Полотенцедержатель/поручень



3221 / 55
 Portasalviette/maniglione di sicurezza
 Towel holder/grab bar
 55,1 x 7 x 3 cm

Porte serviette/barre d'appui
 Handtuchhalter/Wannengriff
 Toallero/asidero
 Полотенцедержатель/поручень



3224

Portarotolo
Toilet paper holder

16 x 8,6 x 3 cm

Porte rouleau
Papierrollenhalter
Portarrollos
Бумагодержатель

3224-O2

Portarotolo di riserva
Spare toilet paper holder

8 x 12,2 x 16 cm

Porte rouleau de réserve
Ersatzpapierrollenhalter
Portarrollos de reserva
Подставка для запасного рулона



3225

Portarotolo coperto
Toilet paper holder with cover

11,7 x 14,2 x 9,6 cm

Porte rouleau avec couvercle
Papierrollenhalter mit Deckel
Portarrollos con tapa
Бумагодержатель с крышкой

3226

Appendiabiti

Hook

3 x 4,6 x 7 cm

Crochet
Haken
Percha
Крючок



3228

Appendiabiti doppio

Double hook

8,4 x 4,6 x 7 cm

Crochet double
Haken doppelt
Percha doble
Двойной крючок



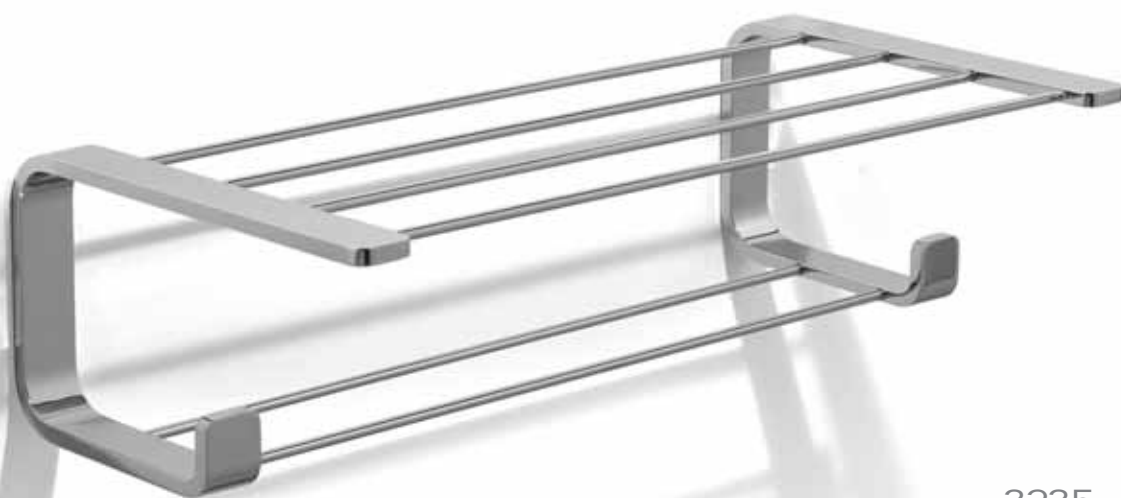

3235

Mensola portaasciugamani doppia
Double shelf for towels

50 x 26 x 14 cm

Étagère porte serviette double
Doppelhandtuchablage
Estante doble para toallas
Двойная полочка для полотенец

3233-03

Scopino WC da muro con ciuffo in setole
Wall toilet brush holder with bristle brush

8 x 9,9 x 38,4 cm

Porte-brosse mural avec brosse en nylon
WC-Bürstengarnitur mit Borsten-Aufsatz mit Wandhalterung
Escobillero de pared con escobilla de nylon
Туалетный ёршик с нейлоновой щетиной

3233

Scopino WC con ciuffo in setole
Toilet brush holder with bristle brush

11,8 x 11,8 x 61,5 cm

Porte-brosse avec brosse en nylon
WC-Bürstengarnitur mit Borsten-Aufsatz
Escobillero con escobilla de nylon
Туалетный ёршик с нейлоновой щетиной

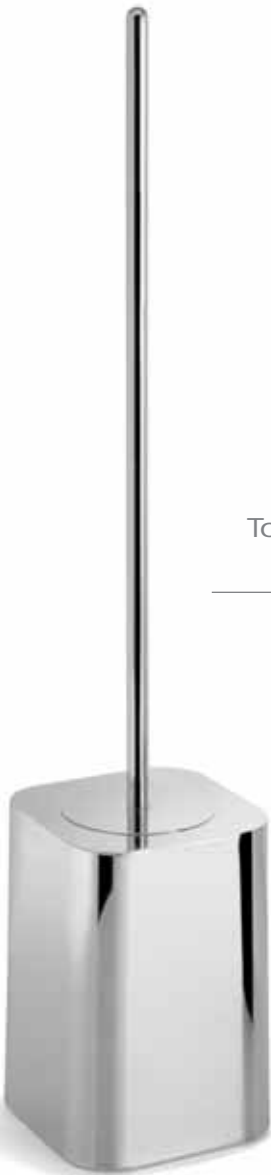

13 Disponibile solo in cromato
Available only in chromed

G• LOUNGE







5410

Portaspazzolini
Toothbrush holder

7 x 9,5 x 9,9 cm

Porte brosse à dents
Zahnbürstenhalter
Portacepillos
Стакан для зубных щёток

5411

Portasapone
Soap holder

12 x 12 x 4,1 cm

Porte savon
Seifenschale
Jabonera
Мыльница



5481

Dosasapone
Soap dispenser

6,8 x 11,6 x 15,6 cm

Distributeur de savon
Seifenspender
Dosificador de jabón
Дозатор для жидкого мыла

G•LOUNGE

13 Cromato
Chromed

14 Nero matt
Matt black

Realizzata in alluminio e Cromall® con contenitori in vetro satinato - Made of aluminium and Cromall® with frosted glass containers
Réalisée en aluminium et Cromall® avec boîtiers en verre satiné - Hergestellt aus Aluminium und Cromall® mit Behältern aus satiniertem Glas
Realizada en aluminio y Cromall® con contenedores en cristal satinado - Изготовлено из латуни и ёмкостями с Cromall® из матового стекла

5412

Portasapone singolo in filo

Wire soap holder

14 x 11 x 2,5 cm

Porte savon fil
Einzel-Seifenablage
Jabonera de rejilla
Проволочная мыльница

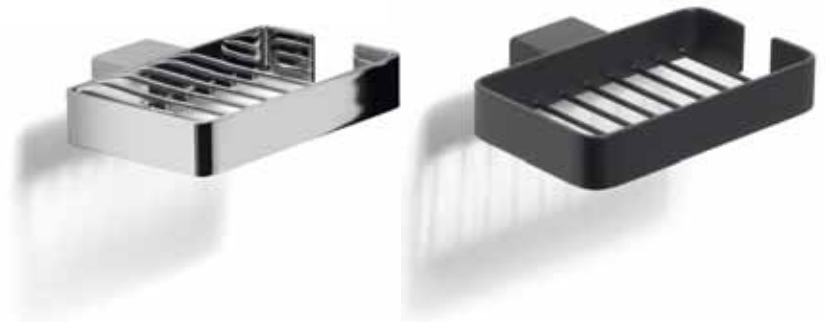

5418

Portasapone doppio in filo
Wire double soap holder

24,6 x 13,7 x 2,5 cm

Porte savon double fil
Doppelte Seifenablage
Jabonera doble de rejilla
Двойная проволочная мыльница



5421-45

Portasalviette
Towel holder

44,2 x 5,4 x 2,4 cm

Porte serviette
Handtuchhalter
Toallero
Полотенцедержатель

5421-60

Portasalviette
Towel holder

59,2 x 5,4 x 2,4 cm

Porte serviette
Handtuchhalter
Toallero
Полотенцедержатель

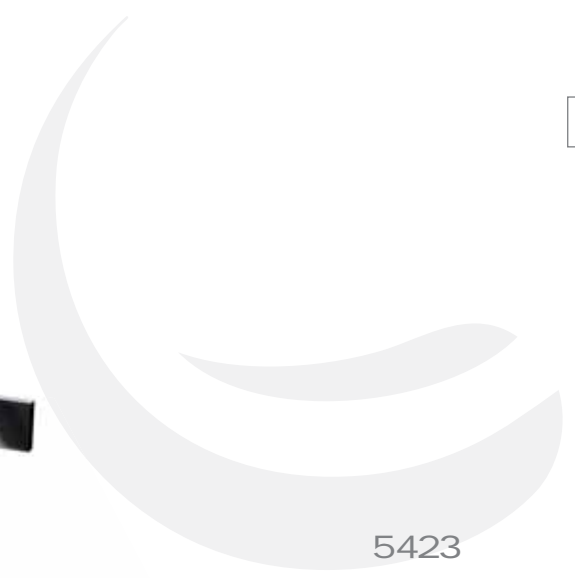

5423

Portasalviette a snodo
Jointed towel holder

4,6 x 37,5 x 2,6 cm

Porte serviette réglable
Handtuchhalter schwenkbar
Toallero articulado
Полотенцедержатель на шарнирах



5470

Portasalviette ad anello
Towel ring

20,3 x 9,8 x 2,4 cm

Anneau porte serviette
Handtuchring
Toallero argolla
Полотенцедержатель "кольцо"





5426
 Appendiabiti doppio
 Double hook
 7 x 3 x 3 cm

Crochet double
 Haken doppelt
 Percha doble
 Крючок

5424
 Portarotolo
 Toilet paper holder
 13 x 9,6 x 2,2 cm

Porte rouleau
 Papierrollenhalter
 Portarrollos
 Бумагодержатель



5425
 Portarotolo coperto
 Toilet paper holder with cover
 13,1 x 13,9 x 4,6 cm

Porte rouleau avec couvercle
 Papierrollenhalter mit Deckel
 Portarrollos con tapa
 Бумагодержатель с крышкой

13 Disponibile solo in cromato
 Available only in chromed

5433-03

Scopino WC da muro con ciuffo in setole
Wall toilet brush holder with bristle brush

8 x 11,2 x 40,4 cm

Porte-brosse mural avec brosse en nylon
WC-Bürstengarnitur mit Borsten-Aufsatz mit Wandhalterung
Escobillero de pared con escobilla de nylon
Туалетный ёршик с нейлоновой щетиной



5433

Scopino WC
con ciuffo in setole
Toilet brush holder
with bristle brush

8 x 8 x 40,4 cm

Porte-brosse avec brosse en nylon
WC-Bürstengarnitur mit Borsten-Aufsatz
Escobillero con escobilla de nylon
Туалетный ёршик с нейлоновой щетиной

5447

Portasalvietta attrezzabile
(accessori venduti separatamente)

Towel rail, with accessories
(accessories supplied separately)

45 x 2,5 x 7,5 cm

Porte-serviette accessoirisable

Ausrüstbarer Handtuchhalter

Toallero equipabile

Полотенцедержатель

горизонтальный или вертикальный



G• LOUNGE

13 Cromato
Chromed

14 Nero matt
Matt black



5451

Portasapone per portasalviette
attrezzabile 5447

Soap dish accessory for towel rail 5447

12 x 12 x 3 cm

Porte-savon pour porte-serviette accessoirisable 5447

Seifenschale für ausrüstbaren Handtuchhalter 5447

Jabonera para toallero equipable 5447

Мыльница для полотенцедержателя 5447

5455

Dosasapone per portasalviette
attrezzabile 5447

Soap dispenser accessory for towel rail 5447

6,5 x 5,5 x 16,5 cm

Distributeur de savon pour porte-serviette accessoirisable 5447

Seifendosierer für ausrüstbaren Handtuchhalter 5447

Dosificador jabón para toallero equipable 5447

Дозатор мыла для полотенцедержателя 5447



5498

Bicchiere per portasalviette attrezzabile 5447

Glass accessory for towel rail 5447

7 x 7 x 10,5 cm

Verre pour porte-serviette accessoirisable 5447

Glas für ausrüstbaren Handtuchhalter 5447

Vaso para toallero equipable 5447

Стакан для полотенцедержателя 5447



5498

Portaspazzolini
Toothbrush holder

7 x 7 x 10 cm

Porte brosse à dents
Zahnbürstenhalter
Portacepillos
Стакан для зубных щёток

5451

Portasapone
Soap holder

11,8 x 11,8 x 5 cm

Porte savon
Seifenschale
Jabonera
Мыльница



5455

Dosasapone
Soap dispenser

7 x 8,9 x 15,5 cm

Distributeur de savon
Seifenspender
Dosificador de jabón
Дозатор для жидкого мыла





5498

Portaspazzolini
Toothbrush holder

7 x 7 x 10 cm

Porte brosse à dents
Zahnbürstenhalter
Portacepillos
Стакан для зубных щёток

5451

Portasapone
Soap holder

11,8 x 11,8 x 5 cm

Porte savon
Seifenschale
Jabonera
Мыльница



5455

Dosasapone
Soap dispenser

7 x 8,9 x 15,5 cm

Distributeur de savon
Seifenspender
Dosificador de jabón
Дозатор для жидкого мыла

G•BRIDGE

design
Carlo Martino







7630

Barra con 3 portasalviette
scorrevoli
Rack with 3 sliding towel rails

40,6 (max 56,2) x 8,3 x 22,6 cm

Barre avec 3 porte-serviettes coulissants
Stange mit 3 verschiebbaren
Handtuchhaltern
Barra con 3 toalleros deslizantes
Вешалка для полотенец
с тремя перемещающимися
перекладинами

7640

Barra con portarotolo doppio e scopino WC
Rack with double toilet roll holder
and toilet brush

30,2 x 12,7 x 37 cm

Barre avec porte-papier WC double et porte-brosse WC
Stange mit doppeltem Rollenhalter und WC-Bürste
Barra con portarrollos doble y escobillero
Двойной держатель для туалетной
бумаги с туалетным ершиком



7633-03

Scopino WC da muro con ciuffo in setole
Wall toilet brush holder
with bristle brush

8 x 10 x 39,2 cm

Porte-brosse mural avec brosse en nylon
WC-Bürstengarnitur mit Borsten-Aufsatz mit Wandhalterung
Escobillero de pared con escobilla de nylon
Туалетный ёршик с нейлоновой щетиной



G•BRIDGE design Carlo Martino

13 Cromato
Chromed

Realizzata in ottone, acciaio inox, Cromall® e contenitori in vetro satinato - Made of brass, stainless steel, Cromall® and frosted glass containers - Réalisée en laiton, acier inoxydable, Cromall® et boîtiers en verre satiné
Hergestellt aus Messing, Edelstahl, Cromall® und Behältern aus satiniertem Glas - Realizada en latón, acero inox, Cromall® y contenedores en cristal satinado - Изготовлено из латуни, нержавеющей стали, Cromall® и матового стекла



7633

Scopino WC con ciuffo in setole
Toilet brush holder with bristle brush

8 x 8 x 39,2 cm

Porte-brosse avec brosse en nylon
WC-Bürstengarnitur mit Borsten-Aufsatz
Escobillero con escobilla de nylon
Туалетный ёршик с нейлоновой щетиной

7631

Piantana con 3 portasalviette scorrevoli
Towel stand with 3 sliding towel rails

40,6 (max 52,6) x 16 x 92 cm

3 porte-serviettes coulissants sur pied
Ständer mit 3 verschiebbaren Handtuchhaltern
Toallero de pie con 3 barras deslizantes
Вертикальная вешалка с тремя перемещающимися перекладинами для полотенец



7632

Colonnina portarotolo e scopino WC
Bathroom butler with toilet paper holder and toilet brush

30 x 16 x 69 cm

Ensemble porte papier et brosse WC
Ständer mit Papierrollenhalter und WC Bürstengarnitur
Columna portarrollos y escobillero
Стойка для ванной с туалетным ершиком и бумагодержателем

G•SISSI

design
Carallo-Grandis







3310
Portaspazzolini
Toothbrush holder
11,7 x 12 x 14,7 cm

Porte brosse à dents
Zahnbürstenhalter
Portacepillos
Стакан для зубных щёток

3311
Portasapone
Soap holder
14,8 x 12,9 x 6,2 cm

Porte savon
Seifenschale
Jabonera
Мыльница



3381
Dosasapone
Soap dispenser
11,6 x 11,9 x 17,5 cm

Distributeur de savon
Seifenspender
Dosificador de jabón
Дозатор для жидкого мыла

G•SISSI

design Carallo-Grandis

13 Cromato
Chromed

87 Oro
Gold

Trattamento oro PVD
PVD gold plated

Realizzata in Cromall® con contenitori in vetro satinato - Made of Cromall® with frosted glass containers - Réalisée en Cromall® avec boîtiers en verre satiné - Hergestellt aus Cromall® mit Behältern aus satiniertem Glas - Realizada en Cromall® con contenedores en cristal satinado - Изготовлено из Cromall® с ёмкостями из матового стекла

3319-60

Mensola
Shelf

60 x 11,5 x 1,5 cm



Étagère - Ablage - Estante - Полочка

Vetro temperato - tempered glass
Verre tempéré - Sekuritglas
Cristal templado - Из закаленного стекла

3321-40

Portasalviette
Towel holder

40,2 x 5,5 x 6,4 cm

Porte serviette
Handtuchhalter
Toallero
Полотенцедержатель

3321-60

Portasalviette
Towel holder

60,3 x 5,5 x 6,4 cm

Porte serviette
Handtuchhalter
Toallero
Полотенцедержатель

3370

Portasalviette ad anello

Towel ring

18,7 x 5,5 x 17,9 cm



Anneau porte serviette
Handtuchring
Toallero argolla
Полотенцедержатель "кольцо"

3326

Appendiabiti doppio

Double hook

9,6 x 5,5 x 5,6 cm

Crochet double
Haken doppelt
Percha doble
Двойной крючок



3324

Portarotolo

Toilet paper holder

17,2 x 5,5 x 6,8 cm



Porte rouleau
Papierrollenhalter
Portarrollos
Бумагодержатель



3333

Scopino WC con ciuffo in setole
Toilet brush holder with bristle brush

ø 11,2 x 37,9 cm

Porte-brosse avec brosse en nylon
WC-Bürstengarnitur mit Borsten-Aufsatz
Escobillero con escobilla de nylon
Туалетный ёршик с нейлоновой щетиной

G•DEMETRA







5110

Portaspazzolini
Toothbrush holder

7,5 x 11,5 x 12 cm

Porte brosse à dents
Zahnbürstenhalter
Portacepillos
Стакан для зубных щёток

5111

Portasapone
Soap holder

16 x 11,5 x 5,5 cm

Porte savon
Seifenschale
Jabonera
Мыльница



5181

Dosasapone
Soap dispenser

10 x 12,5 x 18 cm

Distributeur de savon
Seifenspender
Dosificador de jabón
Дозатор для жидкого мыла



G•DEMETRA

13 Cromato
Chromed

Realizzata in ottone con contenitori in vetro satinato - Made of brass with frosted glass containers - Réalisée en laiton avec boîtiers en verre satiné - Hergestellt aus Messing mit Bechern, Schalen und Ablage in Mattglas - Realizada en latón con contenedores en cristal satinado - Изготовлено из латуни с ёмкостями из матового стекла



5121-30
Portasalviette
Towel holder
34,5 x 7 x 4,5 cm

Porte serviette
Handtuchhalter
Toallero
Полотенцедержатель



5121-45
Portasalviette
Towel holder
49,5 x 7 x 4,5 cm

Porte serviette
Handtuchhalter
Toallero
Полотенцедержатель



5121-60
Portasalviette
Towel holder
64,5 x 7 x 4,5 cm

Porte serviette
Handtuchhalter
Toallero
Полотенцедержатель



5123

Portasalviette a snodo
Jointed towel holder

43,5 x 5,5 x 9 cm

Porte serviette réglable
Handtuchhalter schwenkbar
Toallero articulado
Полотенцедержатель на шарнирах

5170

Portasalviette ad anello
Towel ring

24,8 x 8,5 x 14,5 cm

Anneau porte serviette
Handtuchring
Toallero argolla
Полотенцедержатель "кольцо"



5127

Appendiabiti

Hook

4,5 x 6,7 x 6 cm

Crochet
Haken
Percha
Крючок



5125

Portarotolo coperto

Toilet paper holder with cover

15,3 x 8,5 x 11 cm

Porte rouleau avec couvercle
Papierrollenhalter mit Deckel
Portarrollos con tapa
Бумагодержатель с крышкой



5124

Portarotolo

Toilet paper holder

15,5 x 8,5 x 4,5 cm

Porte rouleau
Papierrollenhalter
Portarrollos
Бумагодержатель



G•GEA



**SOLO SU SUPERFICI LISCE
(SPECCHI, PIASTRELLE)**

**FOR FLAT SURFACES
(MIRRORS, TILES) ONLY**

Fissaggio con biadesivo

To be fixed with double-sided sticky tape

Fixation avec adhésif double face

Befestigung mit doppelseitigem Klebeband

Fijación con biadesivo

Крепление при помощи двухсторонней
клеякой ленты







3610

Portaspazzolini
Toothbrush holder

8,3 x 10 x 12,5 cm

Porte brosse à dents
Zahnbürstenhalter
Portacepillos
Стакан для зубных щёток

3611

Portasapone
Soap holder

11 x 11,5 x 5,5 cm

Porte savon
Seifenschale
Jabonera
Мыльница



3626

Appendiabiti
Hook

5,5 x 4,3 x 6,3 cm

Crochet - Haken
Percha - Крючок



3670

Portasalviette ad anello
Towel ring

19,3 x 6 x 21,4 cm

Anneau porte serviette
Handtuchring
Toallero argolla
Полотенцедержатель "кольцо"



3621-35

Portasalviette
Towel holder

36 x 6 x 5,5 cm

Porte serviette
Handtuchhalter
Toallero
Полотенцедержатель

3621-50

Portasalviette
Towel holder

51 x 6 x 5,5 cm

Porte serviette
Handtuchhalter
Toallero
Полотенцедержатель

3621-65

Portasalviette
Towel holder

66 x 6 x 5,5 cm

Porte serviette
Handtuchhalter
Toallero
Полотенцедержатель

3624

Portarotolo
Toilet paper holder
16 x 6 x 5,5 cmPorte rouleau
Papierrollenhalter
Portarrollos
Бумагодержатель

3625

Portarotolo coperto
Toilet paper holder with cover

13,8 x 4,5 x 13 cm

Porte rouleau avec couvercle
Papierrollenhalter mit Deckel
Portarrollos con tapa
Бумагодержатель с крышкой

G•MALDIVE





A621-38

Maniglione/Portasalviette

Grab bar/Towel holder

38 x 6,5 x 3 cm



Barre d'appui/porte serviette
 Wannengriff/Handtuchhalter
 Asidero/toallero
 Поручень/полотенцедержатель

Cromall®

**A621-50**

Maniglione/Portasalviette

Grab bar/Towel holder

50 x 6,5 x 3 cm



Barre d'appui/porte serviette
 Wannengriff/Handtuchhalter
 Asidero/toallero
 Поручень/полотенцедержатель

**A621-65**

Maniglione/Portasalviette

Grab bar/Towel holder

65 x 6,5 x 3 cm



Barre d'appui/porte serviette
 Wannengriff/Handtuchhalter
 Asidero/toallero
 Поручень/полотенцедержатель

**G•MALDIVE****13** Cromato
Chromed

Realizzata in ottone e Cromall® - Made of brass and Cromall® - Réalisée en laiton et Cromall® - Hergestellt aus Messing und Cromall®
 Realizada en latón et Cromall® - Изготовлено из латуни и Cromall®

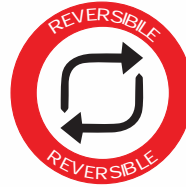
120
kg

A622
Maniglione 135°
Grab bar 135°
56 x 6,5 x 22,8 cm

Barre d'appui 135° - Wannengriff 135° - Asidero 135° - Поручень 135°

A624

Portarotolo
Toilet paper holder
23,5 x 9,5 x 6,5 cm

Porte rouleau
Papierrollenhalter
Portarrollos
Бумагодержатель





SPECCHI INGRANDITORI E ILLUMINAZIONE

Magnifying mirrors and lighting

Miroirs grossissants et luminaires

Vergrößerungsspiegel und Beleuchtung

Espejos de aumento e Iluminación

Увеличительные зеркала и подсветка

Tritan™ un prodotto innovativo e altamente tecnologico. Esclusivo copolyestere, con superlative prestazioni e durata rispetto ad altri materiali plastici, vetro e metallo.

Tritan™ an innovative and high-tech product. Exclusive copolyester, with outstanding performance and durability compared to other plastics, glass and metal.

Tritan™ - http://www.eastman.com/brands/Eastman_Tritan/Media_Center/Video_Library/Pages/toughness.aspx

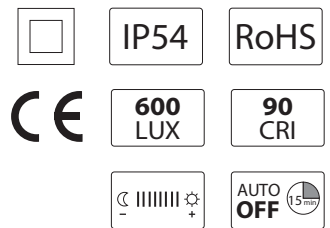
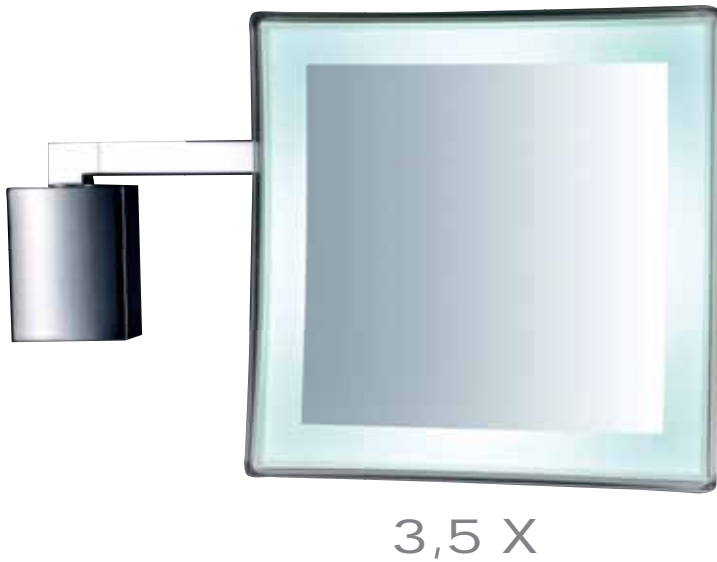

A602

Specchio da parete ingranditore con luce LED
Wall magnifying mirror with LED light

23,5 x 23,5 x 9,4 x 39 cm

Miroir à mural grossissant avec éclairage LED
Vergrößerungs-Wandspiegel mit Beleuchtung LED
Espejo de aumento de pared con luz LED
Настенное увеличительное зеркало со светодиодной подсветкой



G•MALDIVE

13 Cromato
Chromed

Realizzato in ottone/Cromall®/Tritan™ - Made of brass/Cromall®/Tritan™ - Réalisé en laiton /Cromall®/Tritan™ - Hergestellt aus Messing/Cromall®/Tritan™ - Realizado en latón/Cromall®/Tritan™ - Изготовлено из латуни/Cromall®/Tritan™



A601

Specchio da parete ingranditore

Wall magnifying mirror

21,2 x 21,2 x 14,8/44,3 cm

Miroir à mural grossissant

Vergrößerungs - Wandspiegel

Espejo de aumento de pared

Настенное увеличительное зеркало

3,5 X



A600

Specchio da parete ingranditore

Wall magnifying mirror

ø 21,2 x 13,9/43,3 cm

Miroir à mural grossissant

Vergrößerungs - Wandspiegel

Espejo de aumento de pared

Настенное увеличительное зеркало



3,5 X



G•MALDIVE

13 Cromato
Chromed

Realizzato in ottone/Cromall®/Tritan™ - Made of brass/Cromall®/Tritan™ - Réalisé en laiton /Cromall®/Tritan™ - Hergestellt aus
Messing/Cromall®/Tritan™ - Realizado en latón/Cromall®/Tritan™ - Изготовлено из латуни/Cromall®/Tritan™



2118

Specchio ingranditore
da parete con luce LED
Wall magnifying mirrors with LED light
ø 25x12,3/36 cm

Miroir grossissant avec éclairage LED
Kosmetikspiegel mit Beleuchtung LED
Espejos de aumento con luz LED
Увеличительный зеркало со светодиодной
подсветкой



IP 42



5 X

G•VINCENT

13 Cromato
Chromed

Realizzato in acciaio inox - Made of stainless steel - Réalisé en acier inox - Hergestellt aus Edelstahl - Realizado en acero inoxidable
Изготовлено из нержавеющей стали



DO40

Lampada a Led con attacco universale
per specchi senza cornice
LED lamp with universal coupling
for unframed mirrors

10 x 16,8 x 3,4 cm

Lampes LED avec fixation universelle
pour miroirs sans cadre
LED-Lampe mit Universal-Befestigung für rahmenlose Spiegel
Lámpara de led con enganche universal
para espejos sin marco
Светодиодная лампа с универсальным
креплением на зеркала без рамы



IP 44
230V-50Hz
LED 4.4W
420 LM
CLASS EXEMPT GROUP

DO40-01

Lampada a Led con telaio di fissaggio
predisposto per specchi senza cornice
LED lamp with fastening frame
for unframed mirrors

10 x 15,5 x 4,2 cm

Lampes LED avec cadre de fixation conçu
pour les miroirs sans cadre
LED-Lampe mit Befestigungsrahmen für rahmenlose Spiegel
Lámpara de led con bastidor de fijación para espejos sin marco
Светодиодная лампа с креплением на зеркала без рамы



IP 44
230V-50Hz
LED 4.4W
420 LM
CLASS EXEMPT GROUP

DO41

Lampada a Led con attacco universale
per specchi senza cornice
LED lamp with universal coupling
for unframed mirrors

8,1 x 14,8 x 3,2 cm

Lampes LED avec fixation universelle
pour miroirs sans cadre
LED-Lampe mit Universal-Befestigung für rahmenlose Spiegel
Lámpara de led con enganche universal
para espejos sin marco
Светодиодная лампа с универсальным
креплением на зеркала без рамы

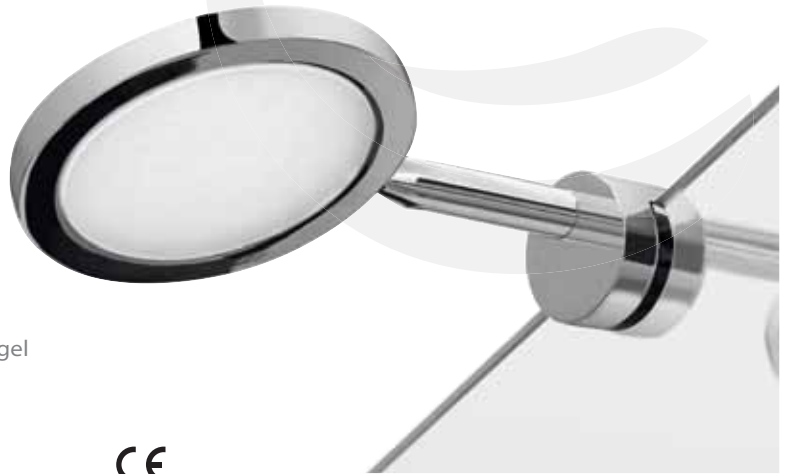

IP 44
230V-50Hz
LED 4.4W
450 LM
CLASS EXEMPT GROUP

**DO41-O1**

Lampada a Led con telaio di fissaggio
predisposta per specchi senza cornice
LED lamp with fastening frame
for unframed mirrors

8,1 x 13,5 x 4,2 cm

Lampes LED avec cadre de fixation conçu
pour les miroirs sans cadre
LED-Lampe mit Befestigungsrahmen
für rahmenlose Spiegel
Lámpara de led con bastidor de fijación
para espejos sin marco
Светодиодная лампа с креплением на зеркала без рамы



IP 44
230V-50Hz
LED 4.4W
450 LM
CLASS EXEMPT GROUP

G•MAIORCA

13 Cromato
Chromed

Realizzate in Cromall® e resine termoplastiche - Made of Cromall® and thermoplastic resins - Réalisées en Cromall® et thermoplastique
Hergestellt aus Cromall® und Kunststoff - Realizadas en Cromall® y resinas termoplásticas - Изготовлено из Cromall® и термопластичных смол

COMPLEMENTI D'ARREDO

Decorative accessories

Accessoires complémentaires

Einrichtungszubehör

Artículos de decoración

Декоративные аксессуары





D031

Piantana portasciugamani

Towel stand

40 x 15 x 80 cm

Porte serviette sur pied
 Handtuchständer
 Toallero de pie
 Стойка для полотенец

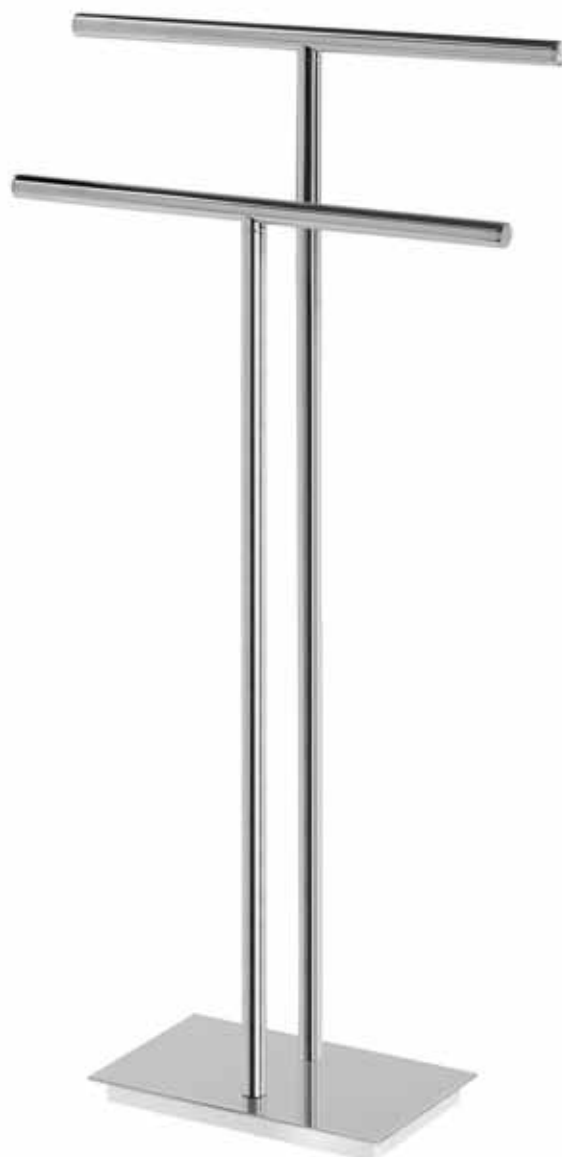

D032

Colonnina portarotolo e scopino WC
 Bathroom butler with toilet paper holder
 and toilet brush

34 x 15 x 68,9 cm

Ensemble porte papier et brosse WC
 Ständer mit Papierrollenhalter und WC Bürstengarnitur
 Columna portarrollos y escobillero
 Стойка для ванной с туалетным ершиком и бумагодержателем

G•BERMUDA

13 Cromato
Chromed

Realizzate in ottone e acciaio inox - Made of brass and stainless steel - Réalisées en laiton et acier inoxydable - Hergestellt aus Messing und Edelstahl - Realizados en latón y acero inox - Изготовлено из латуни и нержавеющей стали

7631

Piantana con 3 portasalviette scorrevoli

Towel stand with 3 sliding towel rails

40,6 (max 52,6) x 16 x 92 cm

3 porte-serviettes coulissants sur pied
 Ständer mit 3 verschiebbaren Handtuchhaltern
 Toallero de pie con 3 barras deslizantes
 Вертикальная вешалка с тремя
 перемещающимися
 перекладинами для полотенец



7632

Colonnina portarotolo e scopino WC
 Bathroom butler with toilet paper holder
 and toilet brush

30 x 16 x 69 cm

Ensemble porte papier et brosse WC
 Ständer mit Papierrollenhalter und WC Bürstengarnitur
 Columna portarrollos y escobillero
 Стойка для ванной с туалетным ершиком и бумагодержателем

G•BRIDGE Design: Carlo Martino

13 Cromato
Chromed

Realizzate in ottone, acciaio inox e Cromall® - Made of brass, stainless steel and Cromall® - Réalisées en laiton, acier inoxydable et Cromall® - Hergestellt aus Messing, Edelstahl und Cromall® - Realizados en latón, acero inox y Cromall®
 Изготовлено из латуни, нержавеющей стали и Cromall®



D027
 Appendiabiti
 Hook
 Ø 3,5 x 4,4 cm

Crochet
 Haken
 Percha
 Крючок

Ottone - Brass - Laiton - Messing - Latón - Латунь

D026
 Appendiabiti doppio
 Double hook
 11,5 x 4 x 5,3 cm

Crochet double
 Haken doppelt
 Percha doble
 Двойной крючок



Fissaggio con biadesivo
Biadhesive fixing



Fissaggio con biadesivo
Biadhesive fixing

D028
 Appendiabiti
 Hook
 Ø 5,9 x 4 cm

Crochet
 Haken
 Percha
 Крючок

D127

Appendiabiti
Hook

5,3 X 5,3 x 4 cm

Crochet
Haken
Percha
Крючок



Fissaggio con biadesivo
Biadhesive fixing

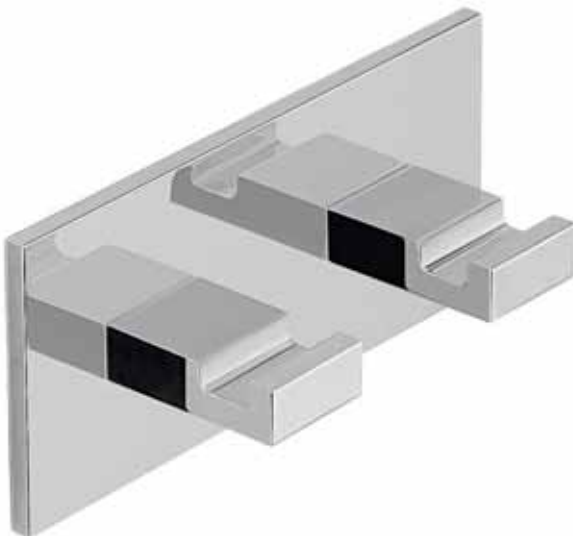

Fissaggio con biadesivo
Biadhesive fixing

D126

Appendiabiti doppio
Double hook

11,5 x 4 x 5,3 cm

Crochet double
Haken doppelt
Percha doble
Двойной крючок

G•MALTA

13 Cromato
Chromed

Realizzati in alluminio - Made of aluminum - Réalisés en aluminium - Hergestellt aus Aluminium - Realizadas en aluminio - Изготовлено из алюминия



A628

Appendiabiti doppio a pinza
Clip-on double hook

3,5 x 5,9 x 5 cm

Patère double à pince
Doppelter Kleiderständer
Percha pinza doble
Двойная вешалка с зажимами

A626

Appendiabiti

Hook

3 x 3 x 9 cm

Crochet
Haken
Percha
Крючок



G•MALDIVE

13

Cromato
Chromed

Realizzati in Cromall® - Made of Cromall® - Réalisés en Cromall® - Hergestellt aus Cromall® - Realizadas en Cromall® - Изготовлено из Cromall®



3626

Appendiabiti

Hook

5,5 x 4,3 x 6,3 cm

Crochet - Haken
Percha - Крючок

G•GEA

13

Cromato
Chromed

Realizzata in ottone e alluminio - Made of brass and aluminium - Réalisée en laiton et aluminium - Hergestellt aus Messing und Aluminium - Realizada en latón y aluminio - Изготовлено из латуни и алюминия



A227

Appendiabiti
Hook

1,8 x 3,5 x 1,8 cm

Crochet
Haken
Percha
Крючок



A226

Appendiabiti doppio
Double hook

7 x 3,5 x 1,8 cm

Crochet double
Haken doppelt
Percha doble
Двойной крючок

A228

Appendiabiti multiplo
Multiple hook

17,2 x 3,5 x 1,8 cm

Crochet quatre têtes
Haken vierfach
Percha cuádruple
Мультикрючок

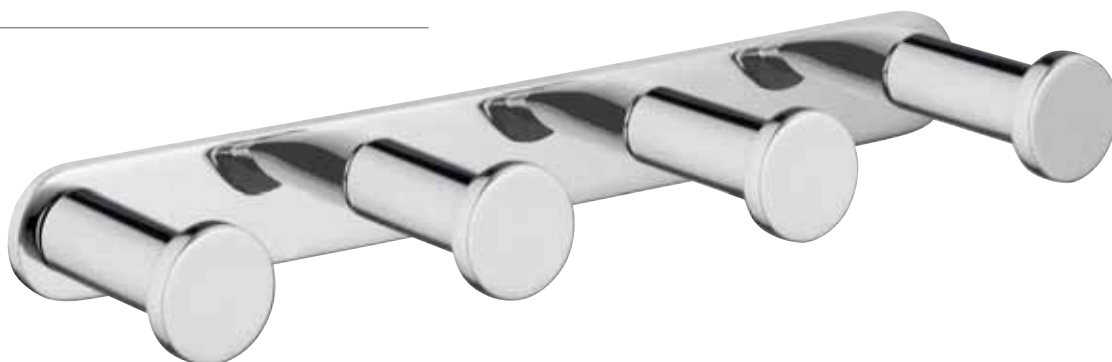

G•CANARIE

13 Cromato
Chromed

Realizzati in ottone - Made of brass - Réalisés en laiton - Hergestellt aus Messing - Realizados en latón - Изготовлено из латуни



SO26

Appendiabiti per box doccia
Hook for shower shower box
4 x 4,5 x 8 cm

Crochet pour cabine douche
Haken für Duschkabinen
Percha para box ducha
Крючок для душевой кабины

SO27

Appendiabiti
Hook
4 x 2,7 x 5,5 cm

Crochet
Haken
Percha
Крючок



Fissaggio con biadesivo
Biadesive fixing



G•EGADI

13 Cromato
Chromed

Realizzati in acciaio inox - Made of stainless steel - Réalisés en inoxydable chromé - Hergestellt aus Edelstahl - Realizados en acero inox
Хромированная сталь

ACCESSORI ZONA DOCCIA

Shower and bathtub accessories

Accessoires pour douche et baignoire

Dusch-und Badewannenzubehör

Complementos de ducha y de bañera

Аксессуары для ванной и душа





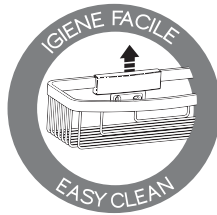

S118

Porta oggetti doccia
Shower caddy

26,3 x 12,7 x 7,2 cm

Porte-objets
Duschhalterung
Portaobjetos
Полочка для ванны

S180

Porta oggetti doccia
Shower caddy

19,6 x 19,6 x 7,2 cm



Porte-objets
Duschhalterung
Portaobjetos
Полочка для ванны



G•TOBAGO

13 Cromato
Chromed

Realizzati in acciaio inox, ottone e Cromall® - Made of chromed stainless steel, brass and Cromall® - Réalisés en acier inoxydable chromé, laiton et Cromall® - Hergestellt aus verchromtem Edelstahl, Messing und Cromall® - Realizados en acero inox cromado, latón y Cromall®
Изготовлено из нержавеющей стали и латуни и Cromall®



A618

Porta oggetti doccia
Shower caddy

24,2 x 11,7 x 7,5 cm

Porte-objets
Duschhalterung
Portaobjetos
Полочка для ванны



A680

Portaoggetti angolare
Corner shower caddy

19 x 19 x 7,5 cm

Porte-objets d'angle
Eckhalterung
Portaobjetos angular
Угловая мыльница

G•MALDIVE



Realizzati in Cromall® e resine termoplastiche - Made of Cromall® and thermoplastic resins - Réalisés en Cromall® et thermoplastique
Hergerstellt aus Cromall® und Kunststoff - Realizados en Cromall® y resinas termoplásticas - Изготовлено из Cromall® и термопластичных смол

S218

Porta oggetti doccia
Shower caddy

27 x 13 x 7,8 cm



Porte-objets
Duschhalterung
Portaobjetos
Полочка для ванны



S282

Porta oggetti doccia
Shower caddy

27 x 13 x 5,8 cm

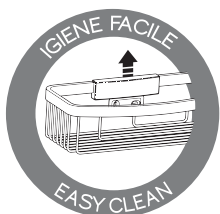

Porte-objets
Duschhalterung
Portaobjetos
Полочка для ванны



G•BARBADOS

13 Cromato
Chromed

Realizzati in ottone e Cromall® - Made of brass and Cromall® - Réalisés en laiton et Cromall® - Hergestellt aus Messing und Cromall®
Realizados en latón y Cromall® - Изготовлено из меди и Cromall®

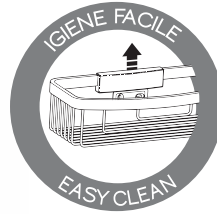
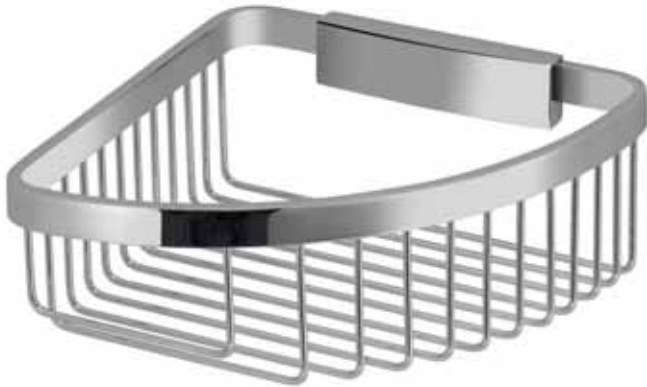
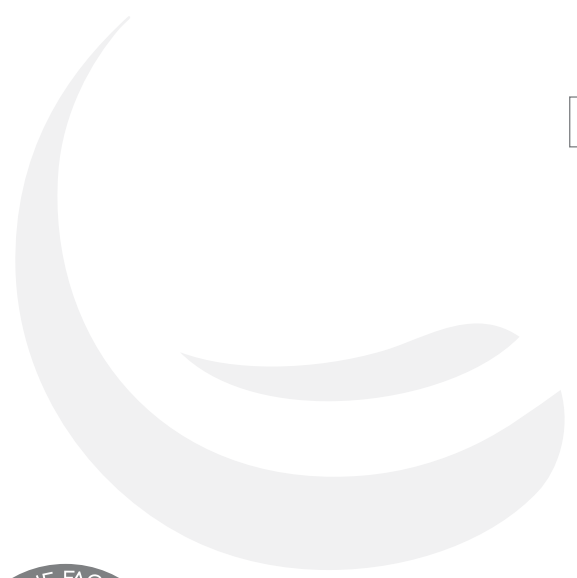

S283

Portaoggetti angolare
Corner shower caddy

19 x 19 x 7,8 cm

Porte-objets d'angle
Eckhalterung
Portaobjetos angular
Угловая мыльница

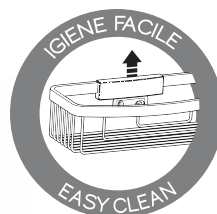

S280

Portaoggetti angolare
Corner shower caddy

19 x 19 x 5,8 cm

Porte-objets d'angle
Eckhalterung
Portaobjetos angular
Угловая мыльница

S018

Porta oggetti doccia
Shower caddy

26 x 13 x 7,5 cm

Porte-objets
Duschhalterung
Portaobjetos
Полочка для ванны

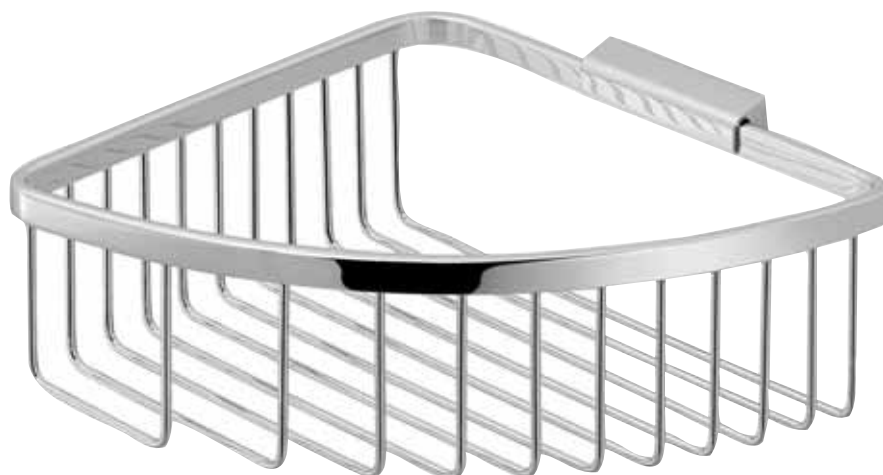
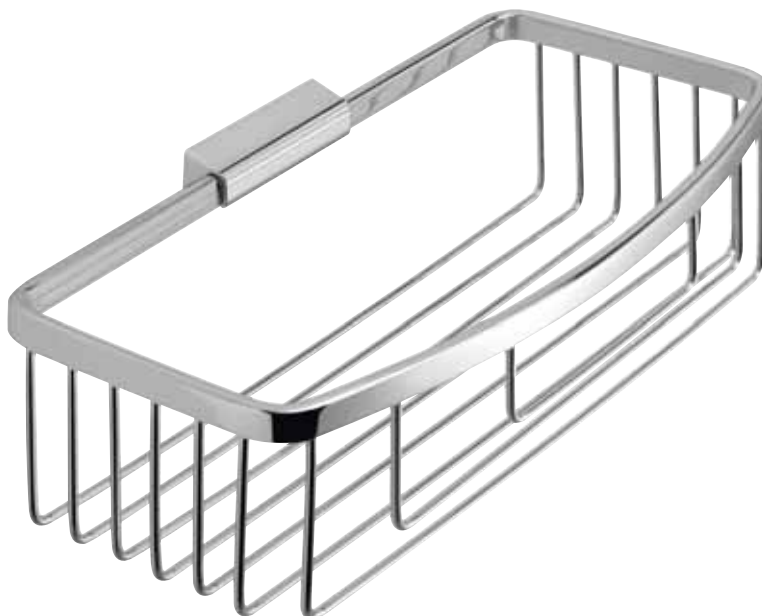

S080

Porta oggetti doccia
Shower caddy

19,5 x 19,5 x 7,5 cm

Porte-objets
Duschhalterung
Portaobjetos
Полочка для ванны

G•TRINIDAD

Realizzati in acciaio inox - Made of stainless steel - Réalisés en acier inoxydable - Hergestellt aus Edelstahl - Realizados en acero inox
Изготовлено из нержавеющей стали

13 Cromato
Chromed

SO41

Tergivetro
Wiper-blade
25 x 2,5 x 17 cm

Raclette de douche
Glasabzieher
Limpiacristales
Стеклоочиститель

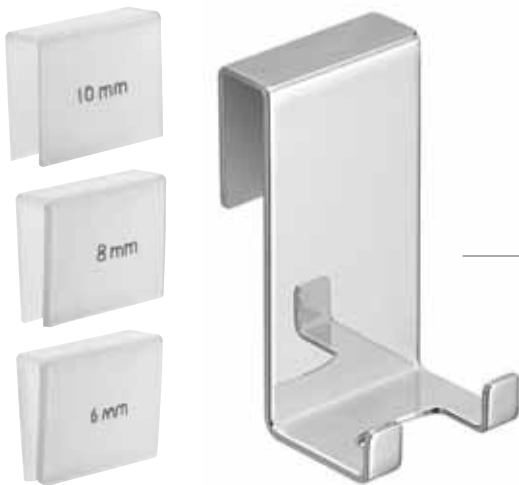
**SO26**

Supporto per SO41
Support for SO41

4 x 4,5 x 8 cm

Crochet amovible pour SO41
Unterstützung für SO41
Soporte para SO41
Поддержка для SO41

SO27

Supporto per SO41
Support for SO41
4 x 2,7 x 5,5 cm

Crochet à fixer pour SO41
Unterstützung für SO41
Soporte SO41
Поддержка для SO41



Fissaggio con biadesivo
Biadhesive fixing



G•EGADI

13 Cromato
Chromed

Realizzati in acciaio inox - Made of stainless steel - Réalisés en acier inoxydable - Hergestellt aus Edelstahl - Realizados en acero inox
Изготовлено из нержавеющей стали

A681

Distributore sapone
Soap dispenser

7 x 8,6 x 23,8 cm - 200 ml

Distributeur de savon
Seifenspender
Dosificador de jabón
Ёмкость для жидкого мыл

A682

Distributore sapone
Soap dispenser

5,5 x 7,1 x 21,6 cm - 350 ml

Distributeur de savon
Seifenspender
Dosificador de jabón
Дозатор для жидкого мыла



RETAIL



Guardare alle cose usuali
con occhi differenti.

Look at usual things
with unusual eyes.





Indice

RETAIL

wall fittings serie da muro

G•ATENA pagina 120

G•EROS pagina 134

G•FEBO pagina 126

G•KARMA pagina 114

table top oggettistica d'appoggio

G•AFRODITE pagina 148

G•CALIPSO pagina 144

G•DAFNE pagina 150

G•GIUNONE pagina 146

G•ISIDE pagina 154

G•MINERVA pagina 158

G•MITRA pagina 156

G•NINFEA pagina 152

G•TINA pagina 142

mirrors specchi pagina 160

bathroom accessories accessori zona wc

e complementi pagina 166

shower and bathtub accessories accessori zona doccia pagina 180

G•KARMA

design
Piet Billekens





3510

Portaspazzolini
Toothbrush holder

8 x 12 x 11,5 cm

Porte brosse à dents
Zahnbürstenhalter
Portacepillos
Стакан для зубных щёток

3511

Portasapone
Soap holder

14 x 14,5 x 9,5 cm

Porte savon
Seifenschale
Jabonera
Мыльница

3581

Dosasapone
Soap dispenser

8 x 12 x 16,5 cm

Distributeur de savon
Seifenspender
Dosificador de jabón
Дозатор для жидкого мыла

G•KARMA design Piet Billekens

02

Cromato con
ceramica lucida
Chromed with glossy
pottery containers

13

Cromato
Chromed

Realizzata in ottone e Cromall® con contenitori in ceramica - Made of brass and Cromall® with pottery containers - Réalisée en laiton et Cromall® avec boîtiers en céramique - Hergestellt aus Messing und Cromall® mit Behältern aus Keramik - Realizada en latón y Cromall® con contenedores en cerámica - Изготовлено из латуни и Cromall® с ёмкостями из керамики

3521-30

Portasalviette

Towel holder

30 x 8,5 x 10,7 cm

Porte serviette - Handtuchhalter
Toallero - Полотенцедержатель



3521-45

Portasalviette

Towel holder

45 x 8,5 x 10,7 cm

Porte serviette
Handtuchhalter
Toallero
Полотенцедержатель

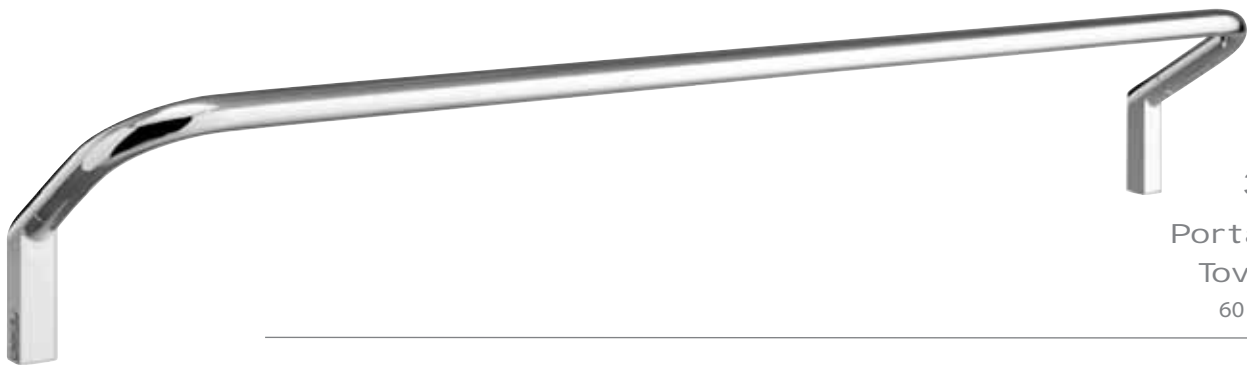

3521-60

Portasalviette

Towel holder

60 x 8,5 x 10,7 cm

Porte serviette
Handtuchhalter
Toallero
Полотенцедержатель

3523

Portasalvietta a snodo
Jointed towel holder

33 x 4,5 x 9 cm

Porte serviette réglable
Handtuchhalter schwenkbar
Toallero articulado
Полотенцедержатель
на шарнирах



3524

Portarotolo
Toilet paper holder

14,5 x 8 x 9,5 cm

Porte rouleau
Papierrollenhalter
Portarrollos
Бумагодержатель

3527

Appendiabiti
Hook

1,4 x 3 x 8,8 cm

Crochet
Haken
Percha
Крючок



3570

Portasalvietta
ad anello

Towel ring

19 x 8 x 12,4 cm

Anneau porte serviette
Handtuchring
Toallero argolla
Полотенцедержатель
"кольцо"

3533

Scopino WC con ciuffo in setole
Toilet brush holder with bristle brush
ø 10 x 38,2 cm

Porte balai avec brosse en nylon
WC-Bürstengarnitur mit Borsten-Aufsatz
Escobillero con escobilla de nylon
Туалетный ёршик с нейлоновой щетиной



3533-03

Scopino WC da muro con ciuffo in setole
Wall toilet brush holder with bristle brush
10 x 14 x 38 cm

Porte brosse mural avec brosse en nylon
WC-Bürstengarnitur mit Borsten-Aufsatz mit Wandhalterung
Escobillero de pared con escobilla de nylon
Настенный туалетный ёршик с нейлоновой щеткой

G•ATENA



FISSABILE ANCHE CON COLLA (VENDUTA A PARTE)

Can be fixed with glue (sold separately)
Peut être fixé avec de la colle
(vendu séparément)
Kann mit Kleber fixiert werden
(separat erhältlich)
Может быть закреплен клеем
(продается отдельно)





4410

Portaspazzolini
Toothbrush holder

8,1 x 10 x 10,7 cm

Porte brosse à dents
Zahnbürstenhalter
Portacepillos
Стакан для зубных щёток



4411

Portasapone
Soap holder

11,5 x 10 x 3,9 cm

Porte savon
Seifenschale
Jabonera
Мыльница

4481

Dosasapone
Soap dispenser

8,1 x 11,1 x 16,4 cm

Distributeur de savon
Seifenspender
Dosificador de jabón
Диспенсер для жидкого мыла



4421-30

Portasalviette
Towel holder

35 x 5,6 x 3,5 cm

Porte serviette
Handtuchhalter
Toallero
Полотенцедержатель



4421-45

Portasalviette
Towel holder

45 x 5,6 x 3,5 cm

Porte serviette
Handtuchhalter
Toallero
Полотенцедержатель

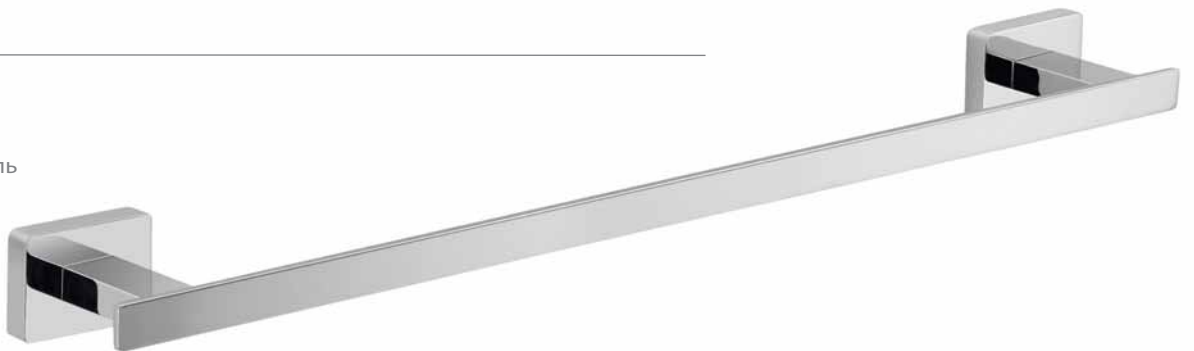

4421-60

Portasalviette
Towel holder

60 x 5,6 x 3,5 cm

Porte serviette
Handtuchhalter
Toallero
Полотенцедержатель

4424

Portarotolo
Toilet paper
holder

19 x 6,4 x 3,5 cm

Porte rouleau
Papierrollenhalter
Portarrollos
Бумагодержатель



4426

Appendiabiti doppio
Double hook

8,8 x 4,5 x 3,5 cm

Crochet double
Haken doppelt
Percha doble
Двойной крючок

4470

Portasalviette ad anello
Towel ring

22,5 x 5,6 x 14,5 cm

Anneau porte serviette
Handtuchring
Toallero argolla
Полотенцедержатель "кольцо"





4425
Portarotolo coperto
Toilet paper holder with cover
13 x 5,3 x 11,3 cm

Porte rouleau avec couvercle
Papierrollenhalter mit Deckel
Portarrollos con tapa
Бумагодержатель с крышкой

4433-03

Scopino WC da muro con ciuffo in setole
Wall toilet brush holder with bristle brush
10,2 x 12 x 37,5 cm

Porte balai mural avec brosse en nylon
Bürstengarnitur mit Borsten-Aufsatz mit Wandhalterung
Escobillero de pared con escobilla de nylon
Настенный туалетный ёршик с нейлоновой щетиной



G•FEBO



FISSABILE ANCHE CON COLLA (VENDUTA A PARTE)

Can be fixed with glue (sold separately)
Peut être fixé avec de la colle
(vendu séparément)
Kann mit Kleber fixiert werden
(separat erhältlich)
Может быть закреплен клеем
(продается отдельно)





5310

Portaspazzolini
Toothbrush holder
6,8 x 10 x 10,5 cm

Porte brosse à dents
Zahnbürstenhalter
Portacepillos
Стакан для зубных щёток



5311

Portasapone
Soap holder
10,8 x 11,9 x 7 cm

Porte savon
Seifenschale
Jabonera
Мыльница



5381

Dosasapone
Soap dispenser
6,8 x 10 x 15,9 cm

Distributeur de savon
Seifenspender
Dosificador de jabón
Дозатор для жидкого мыла



5319-60

Mensola
Shelf
60 x 14,5 x 7 cm



Étagère - Ablage
Estante - Полочка

Vetro temperato
Tempered glass
Verre tempéré
Sekuritglas
Cristal templado
из закаленного стекла

fissaggio solo con viti
to be fixed with screws



G•FEBO

13 Cromato
Chromed

Realizzata in acciaio inox e Cromall® con contenitori in vetro satinato - Made of stainless steel and Cromall® with frosted glass containers
Réalisée en acier inoxydable et Cromall® avec boîtiers en verre satiné - Hergestellt aus Edelstahl und Cromall® mit Behältern aus satiniertem Glas - Realizada en acero inoxidable y Cromall® con contenedores en cristal satinado - Изготовлено из нержавеющей стали и Cromall® с ёмкостями из матового стекла

5321-35

Portasalviette
Towel holder

35 x 7 x 7 cm

Porte serviette - Handtuchhalter
Toallero - Полотенцедержатель



5321-45

Portasalviette
Towel holder

45 x 7 x 7 cm

Porte serviette
Handtuchhalter
Toallero
Полотенцедержатель

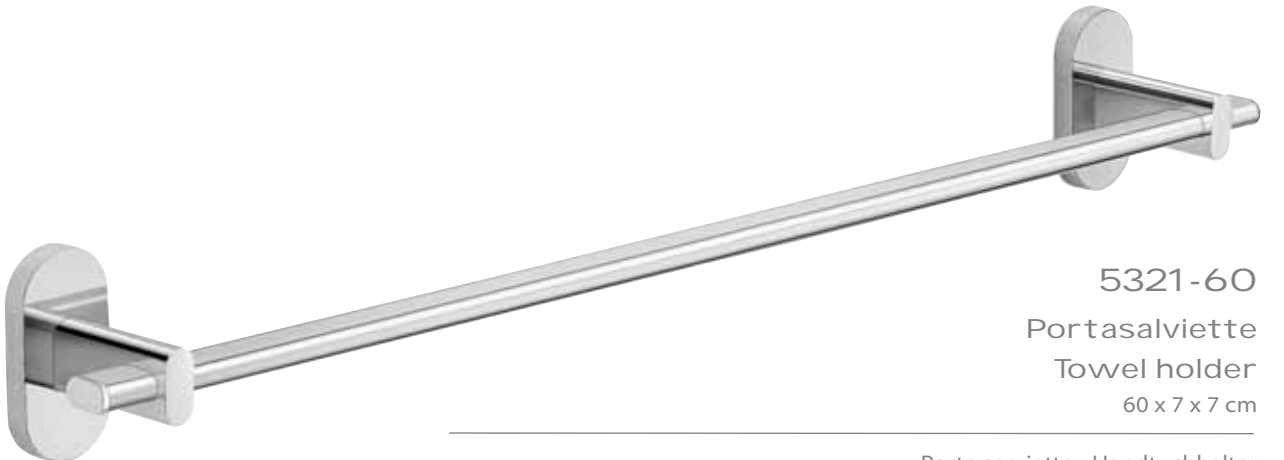

5321-60

Portasalviette
Towel holder

60 x 7 x 7 cm

Porte serviette - Handtuchhalter
Toallero - Полотенцедержатель

5370

Portasalviette ad anello

Towel ring

23 x 7 x 17,9 cm

Anneau porte serviette

Handtuchring

Toallero argolla

Полотенцедержатель "кольцо"



5326

Appendiabiti doppio

Double hook

8,5 x 7 x 7 cm

Crochet double

Haken doppelt

Percha doble

Двойной крючок



5323

Portasalviette a snodo

Jointed towel holder

35 x 4,8 x 9,8 cm

Porte serviette réglable

Handtuchhalter schwenkbar

Toallero articulado

Полотенцедержатель на шарнирах

fissaggio solo con viti
to be fixed with screws



5329
Portarotolo doppio
Double toilet paper holder
26,6 x 7 x 7 cm

Porte rouleau double
Papierrollenhalter doppelt
Portarrollos doble
Двойной бумагодержатель

5324
Portarotolo
Toilet paper holder
16 x 7 x 7 cm

Porte rouleau
Papierrollenhalter
Portarrollos
Бумагодержатель





5325

Portarotolo coperto
Toilet paper holder with cover

16,3 x 8 x 14,3 cm

Porte rouleau avec couvercle
Papierrollenhalter mit Deckel
Portarrollos con tapa
Бумагодержатель с крышкой

5333-03

Scopino WC da muro con ciuffo in setole
Wall toilet brush holder with bristle brush
8,5 x 12 x 36,6 cm

Porte balai à mur avec brosse en nylon
Bürstengarnitur mit Borsten-Aufsatz mit Wandhalterung
Escobillero de pared con escobilla de nylon
Настенный туалетный ёршик с нейлоновой щетиной



5344

Mensola portasciugamani

Shelf for towels

52,4 x 25,2 x 7 cm

Étagère porte serviettes
Handtuchablage
Estante para toallas
Полочка для полотенец

fissaggio solo con viti
to be fixed with screws

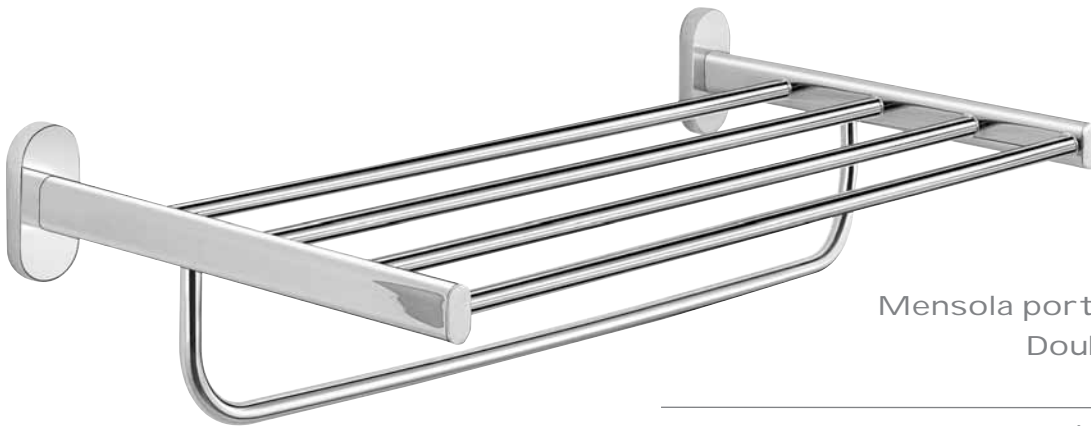
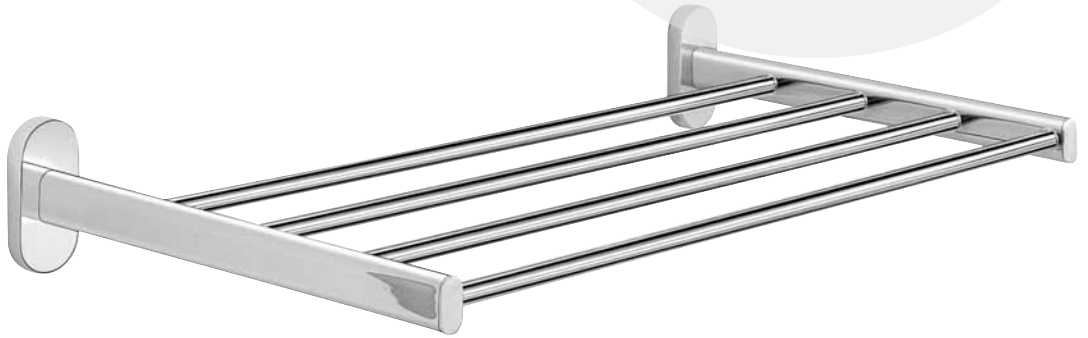

5335

Mensola portasciugamani doppia

Double shelf for towels

52,4 x 25,2 x 12 cm

Étagère double porte serviettes
Handtuchablage doppelt
Estante doble para toallas
Полочка для полотенец

fissaggio solo con viti
to be fixed with screws

G•EROS



FISSABILE ANCHE CON COLLA (VENDUTA A PARTE)

Can be fixed with glue (sold separately)
Peut être fixé avec de la colle
(vendu séparément)
Kann mit Kleber fixiert werden
(separat erhältlich)
Может быть закреплен клеем
(продается отдельно)





2310

Portaspazzolini
Toothbrush holder

6,8 x 10,7 x 9,6 cm

Porte brosse à dents
Zahnbürstenhalter
Portacepillos
Стакан для зубных щёток



2311

Portasapone
Soap holder

10,8 x 12,5 x 5,6 cm

Porte savon
Seifenschale
Jabonera
Мыльница



2381

Dosapapone
Soap dispenser

6,8 x 10,7 x 15,9 cm

Distributeur de savon
Seifenspender
Dosificador de jabón
Дозатор для жидкого мыла



2319-60

Mensola
Shelf

60 x 14,4 x 5 cm

Étagère - Ablage
Estante - Полочка

Vetro temperato
Tempered glass
Verre tempéré
Sekuritglas
Cristal templado
из закаленного стекла

fissaggio solo con viti
to be fixed with screws



G•EROS

13 Cromato
Chromed

NEW

14 Nero matt
Matt black

Realizzata in acciaio inox e Cromall® con contenitori in vetro satinato - Made of stainless steel and Cromall® with frosted glass containers
Réalisée en acier inoxydable et Cromall® avec boîtiers en verre satiné - Hergestellt aus Edelstahl und Cromall® mit Behältern aus satiniertem Glas - Realizada en acero inoxidable y Cromall® con contenedores en cristal satinado - Изготовлено из нержавеющей стали и Cromall® с ёмкостями из матового стекла

2321-35

Portasalviette

Towel holder

35 x 7,6 x 5 cm

Porte serviette - Handtuchhalter
Toallero - Полотенцедержатель



2321-45

Portasalviette

Towel holder

45 x 7,6 x 5 cm

Porte serviette
Handtuchhalter
Toallero
Полотенцедержатель



2321-60

Portasalviette

Towel holder

60 x 7,6 x 5 cm

Porte serviette - Handtuchhalter
Toallero - Полотенцедержатель



2370

Portasalviette ad
anello

Towel ring

20,5 x 4,2 x 16,7 cm

Anneau porte serviette
Handtuchring
Toallero argolla
Полотенцедержатель "кольцо"



2323

Portasalviette
a snodo
Jointed towel
holder

35 x 4,5 x 6 cm

Porte serviette réglable
Handtuchhalter schwenkbar
Toallero articulado
Полотенцедержатель на шарнирах

fissaggio solo con viti
to be fixed with screws



2355

Porta asciugacapelli
Hairdryer support

9,5 x 12,5 x 17 cm

Support sèche-cheveux
Haartrocknerhalter
Soporte para secador de pelo
Держатель для фена



2326

Appendiabiti doppio
Double hook

7 x 4,6 x 5 cm

Crochet double - Haken doppelt
Percha doble - Двойной крючок





2324
Portarotolo
Toilet paper holder
16 x 7,6 x 5 cm

Porte rouleau
Papierrollenhalter
Portarrollos
Бумагодержатель

2325

Portarotolo coperto
Toilet paper holder with cover
13,5 x 5,2 x 13,6 cm

Porte rouleau avec couvercle
Papierrollenhalter mit Deckel
Portarrollos con tapa
Бумагодержатель с крышкой



2333-03

Scopino WC da muro con ciuffo in setole
Wall toilet brush holder with bristle brush
8,5 x 12 x 36,6 cm

Porte balai mural avec brosse en nylon
Bürstengarnitur mit Borsten-Aufsatz mit Wandhalterung
Escobillero de pared con escobilla de nylon
Настенный туалетный с нейлоновой щетиной



OGGETTISTICA D'APPOGGIO

Table top lines
Accessoires à poser
Badausstattung
Serie de apoyo
Настольные аксессуары







6898

Portaspazzolini - Toothbrush holder holder

Porte brosse à dents - Zahnbürstenhalter
 Portacepillos - Стакан для зубных щёток
 9,2 x 6,3 x 11,2 cm

6811

Portasapone - Soap holder

Porte savon - Seifenschale - Jabonera - Мыльница
 14,7 x 10,7 x 2,5 cm

6881

Dosasapone - Soap dispenser

Distributeur de savon - Seifenspende
 Dosificador de jabón - Дозатор для жидкого мыла
 9 x 6,5 x 16 cm

6833

Scopino WC - Toilet brush

Porte-brosse WC - WC-Bürstengarnitur
 Escobillero - Туалетный ёршик
 10,5 x 7,5 x 39 cm



G•TINA

Realizzata in acciaio inox - Made of stainless steel - Réalisé en acier inoxydable - Hergestellt aus Edelstahl
 Realizada en acero inox - Изготовлено из нержавеющей стали



8798

Portaspazzolini - Toothbrush holder

Porte brosse à dents - Zahnbürstenhalter
 Portacepillos - Стакан для зубных щёток
 ø 7,7 x 11,3 cm

8711

Portasapone - Soap holder

Porte savon - Seifenschale - Jabonera - Мыльница
 11,8 x 7,5 x 2,6 cm

8780

Dosasapone - Soap dispenser

Distributeur de savon - Seifenspender
 Dosificador de jabón - Дозатор для жидкого мыла
 ø 8,2 x 17,6 cm

8733

Scopino WC - Toilet brush

Porte-brosse WC - WC-Bürstengarnitur
 Escobillero - Туалетный ёршик
 ø 10 x 48,7 cm



G•CALIPSO

08 Grigio Grey

Realizzata in cemento - Made of concrete - Réalisé en béton - Hergestellt aus Zement - Realizada en cemento - Изготовлено из бетона



4198

Portaspazzolini - Toothbrush holder

Porte brosse à dents - Zahnbürstenhalter

Portacepillos - Стакан для зубных щёток

ø 8,2 x 9,3 cm

4111

Portasapone - Soap holder

Porte savon - Seifenschale - Jabonera - Мыльница

ø 11,5 x 2,4 cm

4180

Dosasapone - Soap dispenser

Distributeur de savon - Seifenspender

Dosificador de jabón - Дозатор для жидкого мыла

ø 8,2 x 17,5 cm

4133

Scopino WC - Toilet brush

Porte-brosse WC - WC-Bürstengarnitur

Escobillero - Туалетный ёршик

ø 10,3 x 46,5 cm

4106

Vassoio portaoggetti - Tray

Plateau porte-objets - Tablett - Bandeja portaobjetos

Полочка для ваннных принадлежностей

27,5 x 15,5 x 2,8 cm



G•GIUNONE

08

Grigio
Grey

Realizzata in cemento - Made of concrete - Réalisé en béton - Hergestellt aus Zement - Realizada en cemento - Изготовлено из бетона



4998

Portaspazzolini - Toothbrush holder

Porte brosse à dents - Zahnbürstenhalter
 Portacepillos - Стакан для зубных щёток
 ø 7,5 x 11,5 cm

4911

Portasapone - Soap holder

Porte savon - Seifenschale - Jabonera - Мыльница
 12,8 x 8,4 x 3 cm

4980

Dosasapone - Soap dispenser

Distributeur de savon - Seifenspender
 Dosificador de jabón - Дозатор для жидкого мыла
 ø 7,6 x 17,2 cm

4933

Scopino WC - Toilet brush

Porte-brosse WC - WC-Bürstengarnitur
 Escobillero - Туалетный ёршик
 ø 9,3 x 47 cm

4906

Vassoio portaoggetti - Tray

Plateau porte-objets - Tablett - Bandeja portaobjetos
 Полочка для ваннных принадлежностей
 30,5 x 10,4 x 3,2 cm



G•AFRODITE

08 Grigio Grey

Realizzata in cemento/bambù - Made of concrete/bamboo - Réalisé en béton/bambou - Hergestellt aus Zement/Bambus - Realizada en cemento/bambú - Изготовлено из бетона/бамбука



3998

Portaspazzolini - Toothbrush holder

Porte brosse à dents - Zahnbürstenhalter
 Portacepillos - Стакан для зубных щёток
 8 x 8 x 13 cm

3911

Portasapone - Soap holder

Porte savon - Seifenschale - Jabonera - Мыльница
 14 x 8 x 2,2 cm

3980

Dosasapone - Soap dispenser

Distributeur de savon - Seifenspender
 Dosificador de jabón - Дозатор для жидкого мыла
 8 x 8 x 18,5 cm

3933

Scopino WC - Toilet brush

Porte-brosse WC - WC-Bürstengarnitur
 Escobillero - Туалетный ёршик
 9,5 x 9,5 x 47 cm



G•DAFNE

30 Noce
Walnut
colour

Realizzata in bambù - Made of bamboo - Réalisé en bambou - Hergestellt aus Bambus - Realizada en bambú - Изготовлено из бамбука



1398

Portaspazzolini - Toothbrush holder

Porte brosse à dents - Zahnbürstenhalter
 Portacepillos - Стакан для зубных щёток
 12,8 x 5,6 x 8,5 cm

1311

Portasapone - Soap holder

Porte savon - Seifenschale - Jabonera - Мыльница
 12,8 x 8,2 x 3 cm

1380

Dosasapone - Soap dispenser

Distributeur de savon - Seifenspender
 Dosificador de jabón - Дозатор для жидкого мыла
 12,8 x 5,6 x 15,7 cm

1333

Scopino WC - Toilet brush

Porte-brosse WC - WC-Bürstengarnitur
 Escobillero - Туалетный ёршик
 9,3 x 9,3 x 46,2 cm

1306

Vassoio portaoggetti - Tray

Plateau porte-objets - Tablett - Bandeja portaobjetos
 Полочка для ваннных принадлежностей
 29,7 x 15,2 x 2 cm

35

Bambù
 Bamboo



G•NINFEA

02

Bianco
 White

Realizzata in resina/bambù - Made of resin/bamboo - Réalisé en résine/bambou - Hergestellt aus Harz/Bambus - Realizada en resina/bambú
 Изготовлено из смол/бамбука



1898

Portaspazzolini - Toothbrush holder

Porte brosse à dents - Zahnbürstenhalter
 Portacepillos - Стакан для зубных щёток
 ø 8,2 x 8 x 13,2 cm

1811

Portasapone - Soap holder

Porte savon - Seifenschale - Jabonera - Мыльница
 15,2 x 11,5 x 2,9 cm

1881

Dosasapone - Soap dispenser

Distributeur de savon - Seifenspender
 Dosificador de jabón - Дозатор для жидкого мыла
 8,5 x 9,1 x 16,3 cm

1833

Scopino WC - Toilet brush

Porte-brosse WC - WC-Bürstengarnitur
 Escobillero - Туалетный ёршик
 12 x 11,6 x 45,8 cm



G•ISIDE

02

Bianco
White

14

Nero matt
Matt black

Realizzata in resina - Made of resin - Réalisé en résine - Hergestellt aus Harz - Realizada en resina - Изготовлено из песка

02

Realizzata in resina e sabbia - Made of resin and sand - Réalisé en résine et sable - Hergestellt aus Harz und Sand
 Realizada en resina y arena - Изготовлено из смол и песка

14



1998

Portaspazzolini - Toothbrush holder

Porte brosse à dents - Zahnbürstenhalter

Portacepillos - Стакан для зубных щёток

ø 10,5 x 10,5 cm

1911

Portasapone - Soap holder

Porte savon - Seifenschale - Jabonera - Мыльница

ø 12 x 2,5 cm

1980

Dosasapone - Soap dispenser

Distributeur de savon - Seifenspender

Dosificador de jabón - Ёмкость для жидкого мыла

ø 10,5 x 15 cm

1985

Dosasapone - Soap dispenser

Distributeur de savon - Seifenspender

Dosificador de jabón - Дозатор для жидкого мыла

ø 14,5 x 11 cm

1933

Scopino WC - Toilet brush

Porte-brosse WC - WC-Bürstengarnitur

Escobillero - Туалетный ёршик

ø 13,5 x 47 cm



G•MITRA

03

Beige
Beige

Realizzata in resina e sabbia - Made of resin and sand - Réalisé en résine et sable - Hergestellt aus Harz und Sand - Realizada en resina y arena
 Изготовлено из смол и песка



1298

Portaspazzolini - Toothbrush holder

Porte brosse à dents - Zahnbürstenhalter
 Portacepillos - Стакан для зубных щёток
 7,4 x 7,4 x 11,7 cm

1211

Portasapone - Soap holder

Porte savon - Seifenschale - Jabonera - Мыльница
 12,6 x 8,5 x 2 cm

1280

Dosasapone - Soap dispenser

Distributeur de savon - Seifenspender
 Dosificador de jabón - Дозатор для жидкого мыла
 7,4 x 7,4 x 15,2 cm

1233

Scopino WC - Toilet brush

Porte-brosse WC - WC-Bürstengarnitur
 Escobillero - Туалетный ёршик
 9,6 x 9,6 x 46,6 cm



G•MINERVA

03

Beige
Beige

85

Antracite
Anthracite

Realizzata in resina e sabbia - Made of resin and sand - Réalisé en résine et sable - Hergestellt aus Harz und Sand - Realizada en resina y arena
 Изготовлено из смол и песка

SPECCHI E SPECCHI INGRANDITORI

Mirrors and magnifying mirrors

Miroirs grossissants et miroirs

Vergrößerungsspiegel und Spiegel

Espejos de aumento e espejos

Увеличительные зеркала и зеркала





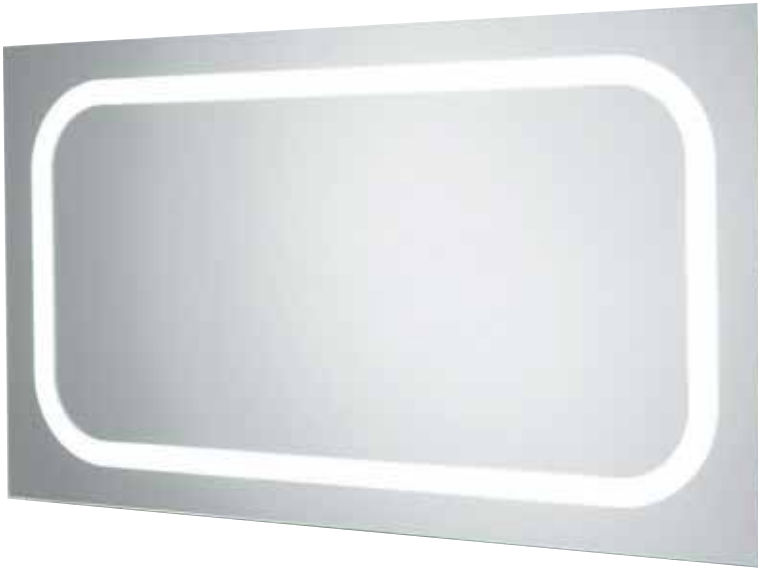

2582 G•RAFAL

Design: Anna Deplano

Specchio retroilluminato

Backlighting mirror

100 x 4,6 x 57,5 cm

Miroir rétroéclairé
Spiegel mit Rückbeleuchtung
Espejo retroiluminado
Зеркало с тыльной подсветкой

CE

IP 44 

2xT9 - W40



2590

Specchio con lastra infrangibile

Mirror with shatterproof surface

60 x 2,5 x 70 cm

Miroir infrangible
Bruchsicherer Spiegel
Espejo irrompible
Зеркало небьющееся

acciaio inox - stainless steel
acier inox - Edelstahl - нержавеющей сталь

Montabile anche in posizione orizzontale
can be mounted horizontally
Montable aussi en position horizontale
Kann auch quer aufgehängt werden
Puede montarse también horizontalmente
Монтируется и горизонтальном положении

100%
made in Italy



13 Super Mirror



2597 G•PLANET

Design: Anna Deplano

Specchio con bordo inciso
Mirror with engraved edge

100 x 2 x 57,5 cm

Spiegel mit geätztem Rand
Espejo con borde grabado
Зеркало с гравированной окантовкой

Montabile anche in posizione verticale
Upright mountable also
Montable aussi en position verticale
Kann auch hoch aufgehängt werden
Montable verticalmente también
Монтируется и вертикальном положении

100%
made in Italy



2596 G•IRIDIUM

Specchio sabbiato
Mirror with sandblasted frame

70 x 2 x 70 cm

Miroir sablé
Spiegel mit mattem Rahmen
Espejo con marco arenado
Зеркало в шлифованной рамке

100%
made in Italy





2 x

2105 G•LAURENT

Specchio ingranditore
con luce

Magnifying mirror
with light

ø 19 cm

Miroir grossissants avec éclairage
Kosmetikspiegel mit Beleuchtung
Espejo de aumento con luz
Увеличительное зеркало с подсветкой

ottone/metallo - brass/metal
laiton/métal - Messing/Metall
latón/metal - латунь/металл

CE

IP 44 

W25 - E14

13 Cromato
Chromed



2 x

2104 G•MICHEL

Specchio ingranditore e non
Magnifying and not magnifying

ø 23,5 cm

Grossissant et non grossissant
Magnifying and non-magnifying mirror
De aumento y normal
Двустороннее увеличительное
и обычное зеркало

ottone - brass
laiton - Messing - латунь

13 Cromato
Chromed



2 x

2111 G•BERTRAND

Specchio ingranditore
Magnifying mirror

15 x 20 x 15 cm

Mirror grossissant
Kosmetikspiegel
Espejo de aumento
Увеличительное зеркало

ottone/metallo - brass/metal
laiton/métal - Messing/Metall
latón/metal - латунь/металл

100%
made in Italy

13 Cromato
Chromed

ACCESSORI ZONA WC E COMPLEMENTI

Bathroom accessories
Accessoires pour wc et compléments
WC-Ausstattung und sonstiges Zubehör
Complementos para wc y artículos de decoración
Комплектующие для туалетной комнаты
и декоративные аксессуары









G•VESTA

5209

Gettacarta - l. 6,6
Waste basket - l. 6,6
ø18,8 x 25 cm

13 Lucido
Polished

Poubelle de salle de bain - l.6,6
Papierkorb - l.6,6
Papelera - l.6,6
Ненужные ящики - l.6,6

acciaio inox - stainless steel
acier inox - Edelstahl
нержавеющая сталь

5309

Design: Carlo Vietri

Gettacarta - l. 9
Waste basket - l. 9
ø 20 x 28,5 cm

Poubelle de salle de bain - l. 9
Papierkorb - l. 9
Papelera - l. 9
Урна для бумаги - l. 9

acciaio inox - stainless steel
acier inox - Edelstahl - нержавеющая сталь

13 Lucido
Polished



CESTINI

Waste bins - Poubelles - Papierkorb - Papeleras - Урна для бумаги

2433-03

Scopino WC con ciuffo in setole
da terra e da muro
Toilet brush with bristle brush
floor standing or wall mounted

ø 8 x 35,5 cm

13 Lucido
Polished

Porte balai WC avec brosse en nylon - à poser et mural
WC-Bürstengarnitur mit Borsten-Aufsatz
Zum Aufstellen oder Aufhängen
Escobillero con escobilla de nylon
de suelo y pared
Туалетный ёршик с нейлоновой щетиной

Ottone
Brass
Laiton
Messing
Latón
Латунь



13 Cromato
Chromed

G•MERCURIO

3633

Scopino WC con ciuffo in setole
Toilet brush with bristle brush

ø 8,3 x 33,6 cm

Porte balai WC avec brosse en nylon
WC-Bürstengarnitur mit Borsten-Aufsatz
Escobillero con escobilla de nylon
Туалетный ёршик с нейлоновой щетиной

Acciaio inox
Stainless steel
Acier inoxydable
Edelstahl
Acero inox
Нержавеющая сталь

SCOPINI WC



13 Cromato
Chromed

G•ARGO

2333

Scopino WC con ciuffo in setole
Toilet brush with bristle brush

ø 9 x 38 cm

Porte balai WC avec brosse en nylon
WC-Bürstengarnitur mit Borsten-Aufsatz
Escobillero con escobilla de nylon
Туалетный ёршик с нейлоновой щетиной

Acciaio inox
Stainless steel
Acier inoxydable
Edelstahl
Acero inox
Нержавеющая сталь

G•TESEO

4433

Scopino WC con ciuffo in setole
Toilet brush with bristle brush

9 x 9 x 38 cm

13 Lucido
Polished

Porte balai WC avec brosse en nylon
WC-Bürstengarnitur mit Borsten-Aufsatz
Escobillero con escobilla de nylon
Туалетный ёршик с нейлоновой щетиной

Acciaio inox - Stainless steel
Acier inoxydable
Edelstahl - Acero inox
Нержавеющая сталь







G•YANNIS

2172

37 x 33,7 x 43,5 cm

Resine termoplastiche e acciaio
 Thermoplastic resins and steel
 Thermoplastique et acier
 Kunststoff und Stahl
 Resinas termoplásticas y acero
 Термопластичные смолы и стали



TEST CONDOTTI DALL'ISTITUTO
 DI CERTIFICAZIONE
 QUALITÀ CABIATO (CO)
 TESTED BY ISTITUTO
 DI CERTIFICAZIONE
 QUALITÀ CABIATO (CO)

Design: LucidiPevere

AS AWARDED BY THE CHICAGO
 ATHENAEUM: MUSEUM
 OF ARCHITECTURE
 AND DESIGN



SGABELLI

Stools - Tabourets - Hocker
 Taburetes - Табуреты

02 Bianco
 White

14 Nero
 Black

3527

Appendiabiti

Hook

1,4 x 3 x 8,8 cm

Crochet - Haken
Percha - Крючок

Cromall®



13

Cromato
Chromed

2227

Appendiabiti

Hook

ø1,6 x 3 cm

Crochet - Haken
Percha - КрючокOttone - Brass
Laiton - Messing
Latón - Латунь

Novità - New



13

Cromato
Chromed

2229

Appendiabiti

Hook

ø1,6 x 5,5 cm

Crochet - Haken
Percha - КрючокOttone - Brass
Laiton - Messing
Latón - Латунь

Novità - New



13

Cromato
Chromed

APPENDIABITI

Hooks - Crochets - Haken - Perchas - Крючки



2226

Appendiabiti doppio
Double hook

8,3 x 3,3 x 4,6 cm

Crochet double - Haken doppelt
Percha doble - Двойной крючок

Ottone - Brass
Laiton - Messing
Latón - Латунь

Novità - New



13 Cromato
Chromed

2228

Appendiabiti multiplo
Multiple hook

20,5 x 3,3 x 4,6 cm

Crochet quatre têtes
Haken vierfach
Percha cuádruple
Мультикрючок

Ottone - Brass
Laiton - Messing
Latón - Латунь

Novità - New



13 Cromato
Chromed





15,3 x 39,4 x 89,9 cm

7331

Piantana portasciugamani
Towel stand

Porte serviette sur pied
Handtuchständer
Toallero de pie
Стойка для полотенец

Cromato
Chromed

13

Realizzate in acciaio inox,
Cromall® e resine termoplastiche

Stainless steel,
Cromall® and thermoplastic resins
Réalisés en acier inoxydable,
Cromall® et thermoplastiquee
Hergestellt aus Edelstahl,
Cromall® und Kunststoff
Realizadas en acero inox,
Cromall® y resinas termoplásticas
Изготовлено из нержавеющей стали,
Cromall® и термопластичных смол



15,3 x 34,3 x 64,4 cm

7332

Colonnina portarotolo e scopino WC
Bathroom butler consisting
of toilet paper holder and toilet brush

Ensemble porte papier et balai de WC
Ständer mit Papierrollenhalter und WC Bürstengarnitur
Columna portarrollos y escobillero
Стойка для ванной с туалетным ершиком и
бумагодержателем

Nero matt
Matt black

NEW

14



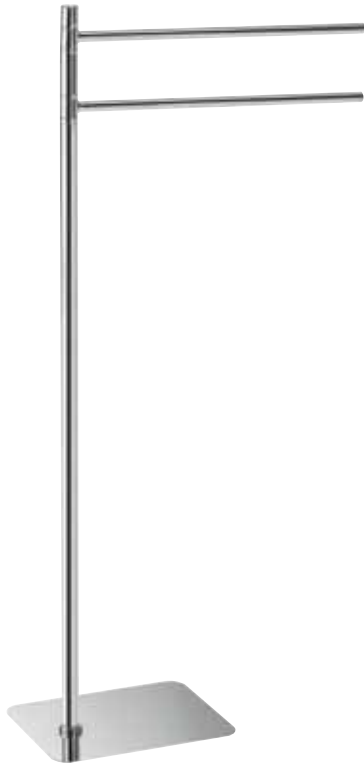

16,4 x 40 x 83,2 cm

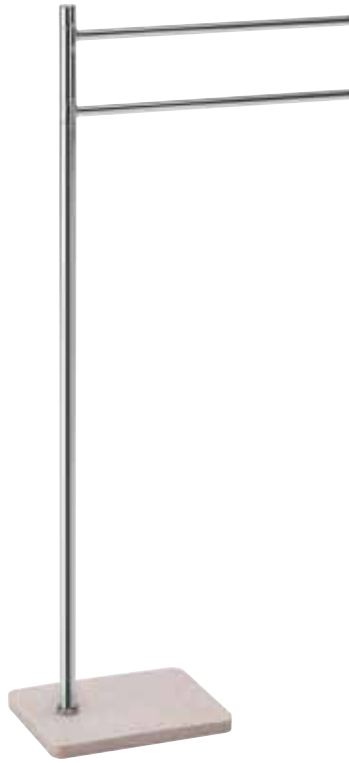

16,7 x 39,6 x 84 cm

1131

Piantana portasciugamani
Towel stand

Porte serviette sur pied
Handtuchständer
Toallero de pie
Стойка для полотенец

Beige
Beige **03**

**Realizzate in acciaio inox,
Cromall®, resina e sabbia**

Made of stainless steel,
Cromall®, resin and sand
Réalisés en acier inoxydable,
Cromall®, résine et sable
Hergestellt aus Edelstahl,
Cromall®, Harz und Sand
Realizadas en acero inox,
Cromall®, resina y arena
Изготовлено из нержавеющей стали,
Cromall®, смол и песка



16,3 x 19 x 62,6 cm



16 x 17 x 65,5 cm

Cromato
Chromed **13**

Realizzate in acciaio inox, Cromall®

Made of stainless steel, Cromall®
Réalisés en acier inoxydable, Cromall®
Hergestellt aus Edelstahl, Cromall®
Realizadas en acero inox, Cromall®
Изготовлено из нержавеющей стали, Cromall®

1132

Colonnina portarotolo e scopino WC
Bathroom butler consisting
of toilet paper holder and toilet brush

Ensemble porte papier et balai de WC
Ständer mit Papierrollenhalter und WC Bürstengarnitur
Columna portarrollos y escobillero
Стойка для ванной с туалетным ершиком и
бумагодержателем

ACCESSORI ZONA DOCCIA

Shower and bathtub accessories

Accessoires pour douche et baignoire

Dusch-und Badewannenzubehör

Complementos de ducha y de bañera

Аксессуары для ванной и душа





5684

25 x 18,8 x 72,5 cm

Acciaio inox AISI 304
 Stainless steel AISI 304
 Acier inoxydable AISI 304
 Edelstahl AISI 304
 Acero inox AISI 304
 Нержавеющая сталь AISI 304

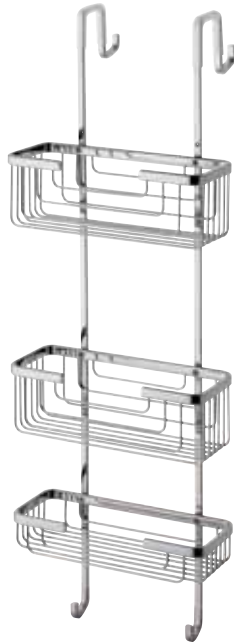

5681

17,3 x 17,3 x 34,5 cm

Ottone
 Brass
 Laiton
 Messing
 Latón
 Латунь

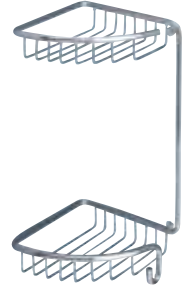

5683

24,5 x 18,5 x 55 cm

Acciaio inox AISI 304
 Stainless steel AISI 304
 Acier inoxydable AISI 304
 Edelstahl AISI 304
 Acero inox AISI 304
 Нержавеющая сталь AISI 304



5620

42,5 x 13 x 11,5 cm

Ottone
 Brass
 Laiton
 Messing
 Latón
 Латунь

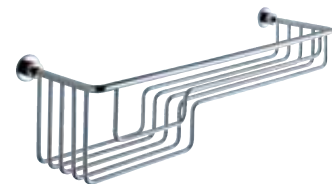

5685

18 x 26,5 x 55,5 cm

Acciaio inox AISI 304
 Stainless steel AISI 304
 Acier inoxydable AISI 304
 Edelstahl AISI 304
 Acero inox AISI 304
 Нержавеющая сталь AISI 304

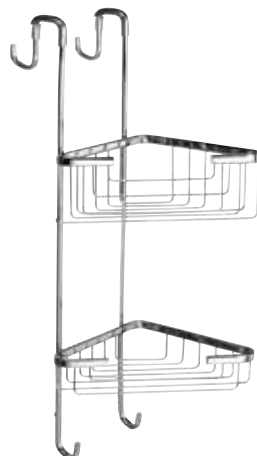

5618

33 x 13 x 7 cm

Ottone - Brass
 Laiton - Messing
 Latón - Латунь



ANGOLARI E PORTA OGGETTI

Corner shelves - Étagères d'angle - Eckablagen - Estantes angulares - Угловая мыльница



2086

150 ml. - 5 x 10 x 17,1 cm

Ottone - Brass
Laiton - Messing
Latón - Латунь

G•KYRON

13 Cromato

Chromed

Dosatore - Soap dispenser - Distributeur de savon - Seifenspender - Dosificadore de jabón - Дозаторы для жидкого мыла

100%
made in Italy



ANTIBATTERICHE
E ANTIMUFFA

ANTIBACTERIAL,
ANTI-MOULD

antibacterienne, antimicrobique
Antibakteriell und Schimmelhemmend
antibacterianas, antimoho
антибактериальные,
антиплесень

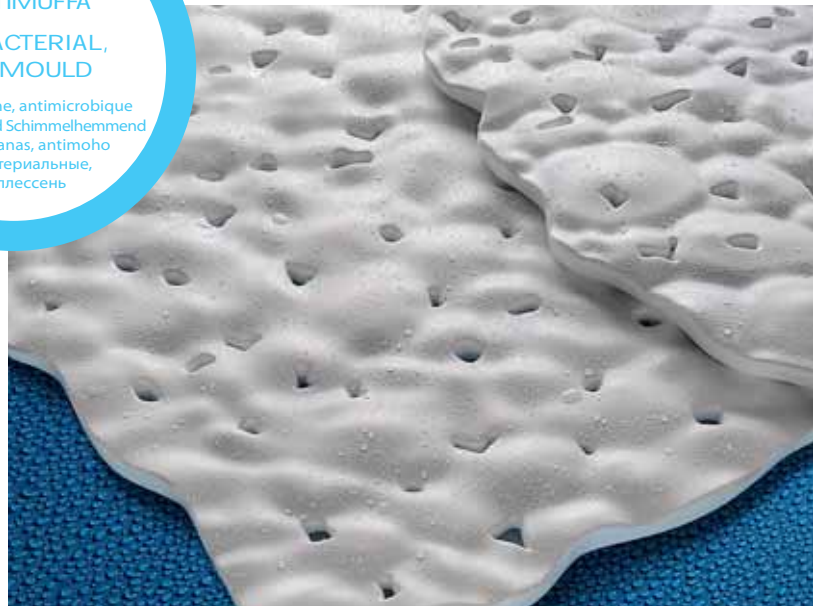

2683 55

55 x 2 x 55 cm

EVA

G•BILBAO

02

Bianco
White

Pedane doccia - Shower mats - Caillebotis - Duschroste - Tarimas para ducha - Коврики для душа



G•THOR

5641

13 Cromato
Chromed

26 X 2,2 X 17,5 cm

Ottone
Brass
Laiton
Messing
Latón
Латуни

Novità - New

TERGIVETRO

Wiper-blade - Raclette de douche - Glasabzieher - Limpiacristales - Стеклоочиститель



G•SIT-IN

4893

98 Iroko
Iroko

120
kg

48,9 x 33 x 10,5 cm

Sedile ribaltabile per doccia - Shower seat
Siège pour douche repliable - Duschsitz hochklappbar
Asiento abatible para ducha - Откидное сиденье для душа

100%
made in Italy

Legno/alluminio/ABS
Wood/aluminium/ABS
Bois/aluminium/ABS
Holz/Aluminium/ABS
Madera/aluminio/ABS
Дерево/алюминий/ABS

SEDILI PER DOCCIA

Shower tub seats - Sièges pour douche - Duschklappsitz
Asientos para ducha - Сидение в душ

GEDY

GEDY





□ WALL

2900	254	G•K2	244
G•BERNINA	214	G•KANSAS	202
G•COLORADO	218	G•KENT	190
G•DARIOS	252	G•MAINE	206
G•EDERA PLUS	224	G•MINDY	264
G•ETNA	240	G•NEW JERSEY	222
G•EVEREST	242	G•OLIMPO	234
G•FELCE	230	G•PIRENEI	198
G•FICUS	238	G•ROMANCE	210
G•GENZIANA	246	G•TEIDE	228
G•GLAMOUR	194	G•VERMONT	216
G•HOT	250	G•VESUVIO	262
G•JUNIOR	258		

■ TABLE TOP

ALTEA	266	GRAZIA	317
AMELIE	293	IDRA	314
ANTARES	322	ILARY	284
AQUARIUS	305	LIBRA	304
ARIES	302	LUCREZIA	277
ASTRID	282	LUCY	278
AZALEA	290	LUNA	329
BAMBU'	268	MARIKA	288
CATHERINE	292	MARINA	275
CHANELLE	320	MOBY	334
CHANTAL	287	MYOSOTIS	276
CLOTHILDE	294	NAOMI	285
DALIA	297	NEMESIA	269
DORI	316	NEW MARTINA	283
ELETTRA	271	NEW MIZAR	280
ERICA	267	NIGELLA	274
ETNICA	308	NIKITA	270
FLOU	328	NORA	300
GEMINI	306	OLIMPIA	315
GINEVRA	299	PETRA	309
GIULIA	326	PETUNIA	298
GLADY	330	PIXIS	336

POLARIS	272	SEVENTY	332
PRIMULA	273	SOFIA	301
QUADROTTO	310	SOLE	312
RAINBOW	324	TWIST	319
RITA	279	VEGA	327
SABINA	286	VERBENA	296
SELINA	318	VIVIENE	295

 **BEAUTY** - PAG. 337

 **HYGIENE** - PAG. 353

 **MULTIFUNCTION** - PAG. 375

 **WATER** - PAG. 409

 **SENSORIAL** - PAG. 475

La sequenza delle misure indicate per ogni articolo è la seguente: larghezza - profondità - altezza
 The succession of the sizes for each article is the following: width - thickness - height
 La séquence des mesures indiquées pour chaque article est la suivante: largeur - profondeur - hauteur
 Die Reihenfolge der Maße, die für jeden Artikel angezeigt werden, ist das folgende: Breite - Tiefe - Höhe
 La secuencia de las medidas indicadas para cada artículo es la siguiente: anchura - profundidad - altura
 Последовательность измерений показанных для каждой статьи: ширина - глубина - высота

Il design non è solo l'aspetto
e la percezione.
Il design è come funziona.

Design is not just
what it looks like and feels like.
Design is how it works.



WALL





G•KENT

13

Cromato
Chromed

Realizzata in ottone e Cromall® con contenitori in vetro satinato

Made of brass and Cromall® with frosted glass containers

Réalisée en laiton et Cromall® avec boîtiers en verre satiné

Hergestellt aus Messing und Cromall® mit Behältern aus satiniertem Glas

Realizada en latón y Cromall® con contenedores en cristal satinado

Изготовлено из латуни и Cromall® с ёмкостями из матового стекла

5510

7,9 x 8,6 x 10,3 cm



5511

11,5 x 9,5 x 2,2 cm



5581

7,9 x 8,6 x 16 cm



5521/30

30,2 x 5,8 x 2,8 cm



5521/45

45 x 5,8 x 2,8 cm



5521/60

60,3 x 5,8 x 2,8 cm





13

Cromato
Chromed



5523

36,5 x 1,5 x 7 cm



5522

35 x 5,5 x 5 cm



Novità - New

5570

23,2 x 5,4 x 14,6 cm



5524

15 x 7 x 2,8 cm



5533

9,7 x 9 x 36,2 cm



5525

15 x 10,7 x 7,7 cm



5427

2,8 x 5 x 3 cm





G•GLAMOUR

Design Piet Billekens

13

Cromato
Chromed



Realizzata in ottone e Cromall® con contenitori in vetro satinato

Made of brass and Cromall® with frosted glass containers

Réalisée en laiton et Cromall® avec boîtiers en verre satiné

Hergestellt aus Messing und Cromall® mit Behältern aus satiniertem Glas

Realizada en latón y Cromall® con contenedores en cristal satinado

Изготовлено из латуни и Cromall® с ёмкостями из матового стекла

5710

8 x 11 x 11 cm



5711

11,2 x 11,4 x 3,4 cm



5781

8 x 11 x 16 cm



5719/60

60 x 11,8 x 2,3 cm

3
kg

Vetro temperato - tempered glass
Verre tempéré - Sekuritglas
Cristal templado - Закаленное стекло



5721/30

30 x 8,2 x 2 cm



5721/45

45 x 8,2 x 2 cm



5721/60

60 x 8,2 x 2 cm







13
Cromato
Chromed

5723 5770

3,2 x 33,5 x 4 cm

24 x 8,2 x 12,4 cm



5724 5726 5733/O3 5733

15,7 x 8,2 x 2 cm

4,2 x 3,7 x 2,6 cm

10 x 13 x 39 cm

10 x 10 x 39 cm



5728

3,2 x 7,7 x 4 cm





G•PIRENEI

Realizzata in ottone e Cromall® con contenitori in vetro satinato

Made of brass and Cromall® with frosted glass containers

Réalisée en laiton et Cromall® avec boîtiers en verre satiné

Hergestellt aus Messing und Cromall® mit Behältern aus satiniertem Glas

Realizada en latón y Cromall® con contenedores en cristal satinado

Изготовлено из латуни и Cromall® с ёмкостями из матового стекла

13

Cromato
Chromed

14

Nero matt
Matt black

PI10

6,9 x 9,1 x 10,4 cm



PI11

11 x 11,2 x 4 cm



PI81

6,9 x 9,1 x 15,4 cm



PI21 / 35

35 x 6,6 x 2,5 cm



PI21 / 45

45 x 6,6 x 2,5 cm



PI21 / 60

60 x 6,6 x 2,5 cm





13

Cromato
Chromed

14

Nero matt
Matt black

PI23

35 x 6,6 x 2,5 cm



PI70

23 x 5 x 15 cm



PI24

17,5 x 6,6 x 2,5 cm



PI27

2 x 3,3 x 5,3 cm



PI33-O3

8,5 x 10,9 x 36,5 cm





G•KANSAS

Realizzata in acciaio inox e Cromall®
con contenitori in vetro satinato o acciaio inox

Made of stainless steel and Cromall®
with frosted glass containers or stainless steel

Réalisée en acier inoxydable et Cromall®
avec boîtiers en verre satiné ou acier inoxydable

Hergestellt aus Edelstahl und Cromall®
mit Behältern aus satiniertem Glas oder Edelstahl

Realizada en acero inox y Cromall®
con contenedores en cristal satinado o acero inox

Изготовлено из нержавеющей стали и Cromall® с ёмкостями
из матового стекла или нержавеющей стали

13

Cromato
Chromed

3810

6,8 x 11,7 x 9,6 cm



3811

10,5 x 13,2 x 4 cm



3881

6,8 x 11,7 x 17 cm



38101310

6,9 x 6,9 x 12,4 cm



38111310

13,8 x 10,6 x 3 cm



38811310

6,9 x 6,9 x 17,3 cm



38101300

7 x 11,3 x 1,8 cm

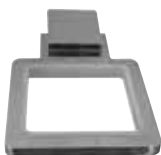

3819/60

60 x 11,7 x 1,6 cm

Vetro temperato - tempered glass
Verre tempéré - Sekuritglas
Cristal templado - Закаленное стекло

3
kg



13

Cromato
Chromed

3821/35

35 x 6,2 x 1,6 cm



3821/45

45 x 6,2 x 1,6 cm

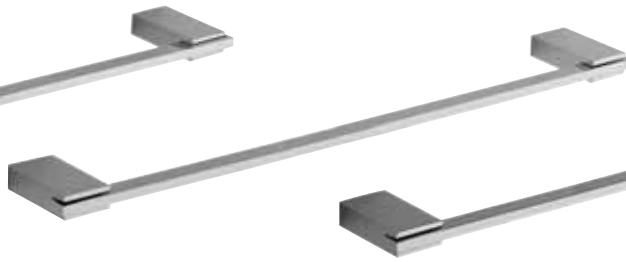

3821/60

60 x 6,2 x 1,6 cm

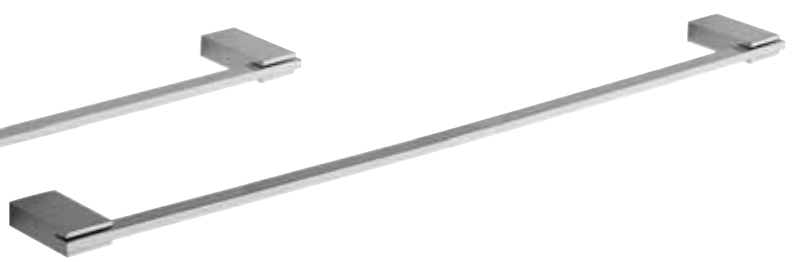

3823

30,4 x 6,2 x 3,8 cm



3822

35 x 6,3 x 3,1 cm



3833

8,7 x 8,7 x 36 cm

Acciaio cromato - Chromed steel
 Acier chromé - Verchromter Stahl
 Асери хромированная сталь



Novità - New

3870

20 x 6,2 x 12,7 cm



3824

14 x 6,2 x 9,7 cm



3826

8,2 x 5,5 x 1,8 cm







13

Cromato
Chromed

3821/45

47,5 x 6,5 x 6 cm



3821/60

62,6 x 6,5 x 6 cm



7823

36 x 5,6 x 6 cm



7870

22,3 x 6,6 x 16,3 cm



7833

ø 8,4 x 36 cm

Acciaio cromato - Chromed steel
 Acier chromé - Verchromter Stahl
 Асеро cromado - Хромированная сталь

7824

15 x 6,6 x 6 cm



7825

14,3 x 6,8 x 15 cm



7826

7,5 x 6,6 x 6 cm





G•ROMANCE

44

Bronzo
Bronzed

Realizzata in acciaio inox e Cromall® con contenitori in vetro satinato
 Made of stainless steel and Cromall® with frosted glass containers
 Réalisée en acier inoxydable et Cromall® avec boîtiers en verre satiné
 Hergestellt aus Edelstahl und Cromall® mit Behältern aus satiniertem Glas
 Realizada en acero inox y Cromall® con contenedores en cristal satinado
 Изготовлено из нержавеющей стали и Cromall® с ёмкостями из матового стекла

10 kg

Fissabile anche con colla (venduta a parte)
 Can be fixed with glue (sold separately)
 Peut être fixé avec colle (vendu séparément)
 Kann mit Kleber fixiert werden (separat erhältlich)
 Se puede fijar con pegamento (se vende por separado)
 Может быть закреплен клеем (продается отдельно)

7510

7,4 x 11,4 x 11,5 cm



7511

14,6 x 11,6 x 5,6 cm



7581

7,2 x 12,3 x 17,4 cm



7519/60

60 x 11 x 5,6 cm



Vetro temperato - tempered glass
 Verre tempéré - Sekuritglas
 Cristal templado - Закаленный стекло

fissaggio con viti - fixed with screws



7521/35

34,8 x 7,7 x 5,6 cm



7521/45

44,8 x 7,7 x 5,6 cm



7521/60

59,8 x 7,7 x 5,6 cm



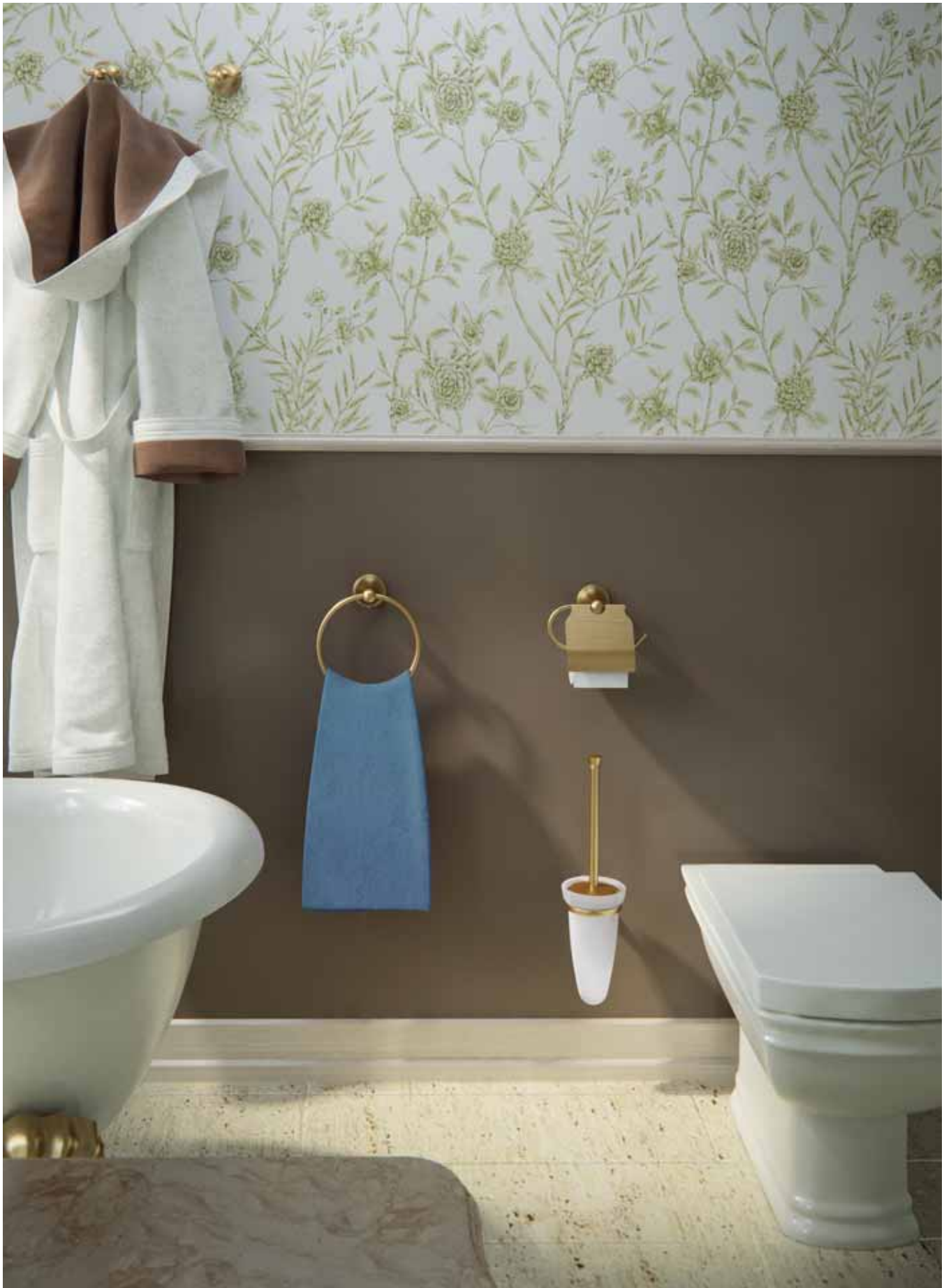

44

Bronzo
Bronzed

7523

36,3 x 7,7 x 7,4 cm
fissaggio con viti - fixed with screws



7570

18 x 7,7 x 20,2 cm



7524

17,8 x 7,7 x 5,6 cm



7525

16,4 x 7,7 x 13,7 cm



7526

8,2 x 7,7 x 5,6 cm



7533/O3

10,9 x 14,5 x 41,8 cm



7533

ø 9 x 41 cm







G•BERNINA

13
Cromato
Chromed



Serie in acciaio inox e Cromall® con contenitori in vetro satinato
 Made of stainless steel and Cromall® with frosted glass containers
 Série en acier inoxydable et Cromall® avec boîtiers en verre satiné
 Serie aus Edelstahl und Cromall® mit Behältern aus satiniertem Glas
 Serie en acero inoxidable y Cromall® con contenedores en cristal satinado
 Изготовлено из нержавеющей стали и Cromall® с ёмкостями из матового стекла







Fissabile anche con colla (venduta a parte)
 Can be fixed with glue (sold separately)
 Peut être fixé avec colle (vendu séparément)
 Kann mit Kleber fixiert werden (separat erhältlich)
 Se puede fijar con pegamento (se vende por separado)
 Может быть закреплен клеем (продается отдельно)

BE10

ø 6,9 x 10,1 x 10,5 cm



BE11

10,8 x 12 x 4 cm



BE81

ø 6,9 x 11,5 x 15,3 cm



BE21 / 35

35 x 5,5 x 3,5 cm



BE21 / 45

45 x 5,5 x 3,5 cm



BE21 / 60

60 x 5,5 x 3,5 cm



BE70

23 x 6,6 x 15 cm



BE24

18,2 x 6,6 x 3,5 cm



BE25

18,3 x 7,3 x 13 cm



BE26

8,5 x 5,6 x 4 cm





G•VERMONT



13
Cromato
Chromed

Realizzata in acciaio inox e Cromall® con contenitori in vetro satinato
Made of stainless steel and Cromall® with frosted glass containers
Réalisée en acier inoxydable et Cromall® avec boîtiers en verre satiné
Hergestellt aus Edelstahl und Cromall® mit Behältern aus satiniertem Glas
Realizada en acero inox y Cromall® con contenedores en cristal satinado
Изготовлено из нержавеющей стали и Cromall® с ёмкостями из матового стекла

Fissabile anche con colla (venduta a parte)
Can be fixed with glue (sold separately)
Peut être fixé avec colle (vendu séparément)
Kann mit Kleber fixiert werden (separat erhältlich)
Se puede fijar con pegamento (se vende por separado)
Может быть закреплен клеем (продается отдельно)

4210 6,5 x 11 x 9,5 cm	4211 11 x 13 x 6 cm	4226 7,5 x 5 x 6 cm
----------------------------------	-------------------------------	-------------------------------



4221/35 35,4 x 8,2 x 6 cm	4221/45 45,5 x 8 x 6 cm	4221/60 60,5 x 9,1 x 6 cm
-------------------------------------	-----------------------------------	-------------------------------------



4223 35 x 7 x 6 cm	4270 22,5 x 6 x 16 cm	4233 ø 9,1 x 37,3 cm
------------------------------	---------------------------------	--------------------------------



4224 18,3 x 8,4 x 6 cm	4225 17 x 6 x 14,5 cm
----------------------------------	---------------------------------





G•COLORADO

13
Cromato
Chromed



Realizzata in acciaio inox e Cromall®
con contenitori in vetro satinato o acciaio inox
Made of stainless steel and Cromall®
with frosted glass containers or stainless steel
Réalisée en acier inoxydable et Cromall®
avec boîtiers en verre satiné ou acier inoxydable
Hergestellt aus Edelstahl und Cromall®
mit Behältern aus satiniertem Glas oder Edelstahl
Realizada en acero inox y Cromall®
con contenedores en cristal satinado o acero inox
Изготовлено из нержавеющей стали и Cromall®
с ёмкостями из матового стекла

Fissabile anche con colla (venduta a parte)
Can be fixed with glue (sold separately)
Peut être fixé avec colle (vendu séparément)
Kann mit Kleber fixiert werden (separat erhältlich)
Se puede fijar con pegamento (se vende por separado)
Может быть закреплен клеем (продается отдельно)

6910

7 x 10,5 x 10,5 cm



6911

10 x 12,5 x 5 cm



6981

7 x 10,5 x 15,5 cm



38101310

6,9 x 6,9 x 12,4 cm



38111310

13,8 x 10,6 x 3 cm



38811310

6,9 x 6,9 x 17,3 cm



69101300

7 x 11,3 x 1,8 cm



6919/60

57 x 11,5 x 4 cm

Vetro temperato - tempered glass
Verre tempéré - Sekuritglas
Cristal templado - Закаленное стекло

fissaggio con viti - fixed with screws

6,5 kg





G•COLORADO

13

Cromato
Chromed

6921/35

35 x 8 x 4 cm

6921/45

45 x 8 x 4 cm

6921/60

60 x 8 x 4 cm



6923

4 x 36 x 5,5 cm

6970

20 x 6,5 x 14,5 cm

6924

17 x 8 x 4 cm

6933

8,7 x 8,7 x 36 cm



Acciaio inox - Stainless steel
 Acier inoxydable - Edelstahl
 Acero inox - Нержавеющая сталь



6925

14,3 x 6,5 x 12 cm

6926

4 x 5 x 4 cm

6928

6,5 x 6 x 4 cm





G•NEW JERSEY



13
Cromato
Chromed

Realizzata in acciaio inox, Cromall® e resine termoplastiche e vetro satinato
 Made of stainless steel, Cromall® and thermoplastic resins and frosted glass
 Réalisée en acier inoxydable, Cromall® et thermoplastique et verre satiné
 Hergestellt aus Edelstahl, Cromall® und Kunststoff und satiniertem Glas
 Realizada en acero inox, Cromall® y resinas termoplásticas y cristal satinado
 Изготовлено из нержавеющей стали, Cromall® и термопластичных смол и матового стекла

Fissabile anche con colla (venduta a parte)
 Can be fixed with glue (sold separately)
 Peut être fixé avec colle (vendu séparément)
 Kann mit Kleber fixiert werden (separat erhältlich)
 Se puede fijar con pegamento (se vende por separado)
 Может быть закреплен клеем (продается отдельно)

2810	2811	2881	2826
6,7 x 9,8 x 9,6 cm	10,9 x 11,9 x 5 cm	6,8 x 11 x 15,5 cm	7 x 6,7 x 4,2 cm



2821/35	2821/45	2821/60
37,6 x 6,7 x 4,2 cm	47,6 x 6,7 x 4,2 cm	62,6 x 6,7 x 4,2 cm



2870	2824	2825	2833
20,5 x 6,7 x 12 cm	17 x 6,7 x 4,2 cm	14,5 x 7,2 x 11 cm	9 x 9 x 38 cm



Acciaio inox - Stainless steel
 Acier inoxydable
 Edelstahl - Acero inox
 Нержавеющая сталь





G•EDERA PLUS

Realizzata in acciaio inox e Cromall® con contenitori in vetro satinato

Made of stainless steel and Cromall® with frosted glass containers

Réalisée en acier inoxydable et Cromall® avec boîtiers en verre satiné

Hergestellt aus Edelstahl und Cromall® mit Behältern aus satiniertem Glas

Realizada en acero inox y Cromall® con contenedores en cristal satinado

Изготовлено из нержавеющей стали и Cromall®

с ёмкостями из матового стекла

13

Cromato
Chromed









Fissabile anche con colla (venduta a parte)
Can be fixed with glue (sold separately)
Peut être fixé avec colle (vendu séparément)
Kann mit Kleber fixiert werden (separat erhältlich)
Se puede fijar con pegamento (se vende por separado)
Может быть закреплен клеем (продается отдельно)

EP10

11,2 x 9,8 x 9,9 cm



EP11

13,7 x 11,9 x 5,7 cm



EP81

11,3 x 11,2 x 15,7 cm



EP12

13 x 11,4 x 5,4 cm

Inamovibile - Fixed



EP19/55

53 x 14,1 x 5,4 cm

Vetro temperato - tempered glass
Verre trempé - Sekuritglas
Cristal templado - Закаленное стекло

fissaggio con viti - fixed with screws

5
kg



EP21/35

38,3 x 7,4 x 5,4 cm



EP21/45

48,3 x 7,4 x 5,4 cm



EP21/60

63,3 x 7,4 x 5,4 cm





G•EDERA PLUS

13

Cromato
Chromed

EP23

36 x 4,6 x 5,4 cm



EP70

20 x 7,4 x 15,7 cm



EP24

14,5 x 7,4 x 5,4 cm



EP24 /O2

8,8 x 10,9 x 17,2 cm



EP25

14,6 x 7,4 x 14,1 cm



EP26

7,6 x 7,4 x 5,4 cm



ED34

ø 7,5 x 40 cm

Acciaio inox - Stainless steel Acier
inoxydable - Edelstahl - Acero inox
Нержавеющая сталь

ED34 /O3

7,5 x 8 x 40 cm

Acciaio inox - Stainless steel Acier
inoxydable - Edelstahl - Acero inox
Нержавеющая сталь



Novità - New

13

Cromato
Chromed

G•TEIDE

Realizzata in acciaio inox, Cromall® con contenitori in vetro satinato

Made of stainless steel, Cromall® with frosted glass containers

Réalisée en acier inoxydable, Cromall® avec boîtiers en verre satiné

Hergestellt aus Edelstahl, Cromall® mit Behältern aus satiniertem Glas

Realizada en acero inox, Cromall® con contenedores en cristal satinado

Изготовлено из нержавеющей стали, Cromall® с ёмкостями из матового стекла

Fissaggio con biadesivo o viti
To be fixed with double-sided
sticky tape or screwsFixation avec adhésif double face ou vis - Befestigung mit
doppelseitigem - Klebeband oder Schrauben
Fijación con adhesivo de dos caras o tornillos - Крепление
при помощи двухсторонней клейкой ленты или шурупов

TE10

6,7 x 9,1 x 9,6 cm



TE11

11 x 11,5 x 5,2 cm



TE55

10 x 14 x 7,3 cm



TE21 / 30

30 x 6,7 x 5,3 cm



TE21 / 45

45,5 x 6,7 x 5,3 cm



TE21 / 60

60 x 6,7 x 5,3 cm



TE26

6,5 x 4,1 x 5,3 cm



TE24

13,2 x 4,5 x 10 cm



TE70

20 x 7,2 x 10 cm





G•FELCE

13

Cromato
Chromed

Realizzata in acciaio inox e Cromall® con contenitori in vetro satinato
 Made of stainless steel and Cromall® with frosted glass containers
 Réalisée en acier inoxydable et Cromall® avec boîtiers en verre satiné
 Hergestellt aus Edelstahl und Cromall® mit Behältern aus satiniertem Glas
 Realizada en acero inox y Cromall® con contenedores en cristal satinado
 Изготовлено из нержавеющей стали и Cromall® с ёмкостями из матового стекла



FISSAGGIO AD INCOLLO • FIXES INTO PLACE WITH GLUE



10 kg



FISSAGGIO CON VITI • FIXES WITH SCREWS



Fissabile anche con colla (venduta a parte)
 Can be fixed with glue (sold separately)
 Peut être fixé avec colle (vendu séparément)
 Kann mit Kleber fixiert werden (separat erhältlich)
 Se puede fijar con pegamento (se vende por separado)
 Может быть закреплен клеем (продается отдельно)

FE10

6,7 x 10,2 x 10 cm



FE11

11 x 12,3 x 5,6 cm



FE81

6,8 x 10,3 x 15,4 cm



FE19/55

52 x 13,1 x 5,6 cm

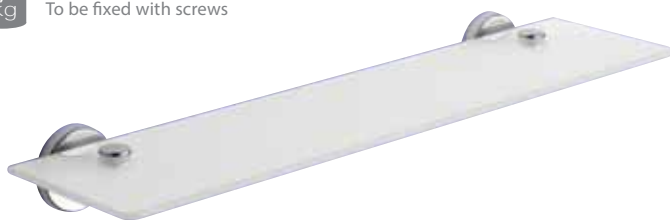
Fissaggio con viti
To be fixed with screws

FE21/35

39,6 x 7,4 x 5,6 cm



FE21/45

52 x 7,4 x 5,6 cm



FE21/60

64,6 x 7,4 x 5,6 cm





13

Cromato
Chromed

FE23

36,9 x 4,8 x 5,6 cm

Fissaggio con viti - To be fixed with screws



FE70

19,3 x 5,5 x 15,2 cm



FE24

5,6 x 12,6 x 5,6 cm



FE29

15,5 x 7,8 x 5,6 cm



FE25

13,5 x 5,5 x 14,5 cm



FE33

ø 7,8 x 33,4 cm

Acciaio inox - Stainless steel
Acier inoxydable - Edelstahl
Асepo inox - Нeржавеющей стали

FE26

6,5 x 5,5 x 5,6 cm







Novità - New

13

Cromato
Chromed

G•OLIMPO

O124

15,2 x 6,8 x 4,5 cm



O125

12,6 x 4,8 x 13 cm



O170

15,6 x 4,8 x 17,3 cm



O126

6,5 x 4,8 x 4,5 cm





G•FICUS

Realizzata in metallo e Cromall® con contenitori in vetro satinato
 Made of metal and Cromall® with frosted glass containers
 Réalisée en métal et Cromall® avec boîtiers en verre satiné
 Hergestellt aus Metall und Cromall® mit Behältern aus satiniertem Glas
 Realizada en metal y Cromall® con contenedores en cristal satinado
 Изготовлено из металла и Cromall® с ёмкостями из матового стекла

13

Cromato
Chromed

FI10	FI11	FI81	FI26
------	------	------	------

6,7 x 10 x 9,5 cm

11 x 12,5 x 5 cm

6,5 x 10,5 x 15 cm

6,5 x 5 x 5 cm



FI19/55	FI21/35
---------	---------

52 x 13 x 5 cm

38,5 x 7 x 5 cm

7,5 kg

Vetro temperato - tempered glass
Verre tempéré - Sekuritglas
Cristal templado - Закаленное стекло



FI21/60	FI23	FI33
---------	------	------

64,5 x 7 x 5 cm

36,9 x 4,8 x 5,6 cm

ø 7,5 x 33 cm



FI70	FI24	FI25
------	------	------

15,6 x 4,7 x 18,2 cm

15,5 x 7 x 5 cm

12,6 x 5,5 x 14 cm





G•ETNA

Realizzata in acciaio e Cromall® con contenitori in vetro satinato
 Made of steel and Cromall® with frosted glass containers
 Réalisée en acier et Cromall® avec boîtiers en verre satiné
 Hergestellt aus Stahl und Cromall® mit Behältern aus satiniertem Glas
 Realizada en acero y Cromall® con contenedores en cristal satinado
 Изготовлено из стали и Cromall® с ёмкостями из матового стекла

13

Cromato
Chromed

EN10

11,7 x 8,7 x 10,3 cm



EN12

11,7 x 8,7 x 4,6 cm

Inamovibile - Fixed



EN26

5,6 x 4,1 x 4,7 cm



EN21 / 35

34,7 x 8,3 x 4,8 cm



EN21 / 45

44,7 x 8,3 x 4,8 cm



EN21 / 60

59,7 x 8,3 x 4,8 cm



EN70

15,7 x 4,5 x 17,6 cm



EN24

16,5 x 8,3 x 4,8 cm





G•EVEREST

Realizzata in acciaio e Cromall® con contenitori in vetro satinato
 Made of steel and Cromall® with frosted glass containers
 Réalisée en acier et Cromall® avec boîtiers en verre satiné
 Hergestellt aus Stahl und Cromall® mit Behältern aus satiniertem Glas
 Realizada en acero y Cromall® con contenedores en cristal satinado
 Изготовлено из стали и Cromall® с ёмкостями из матового стекла

13

Cromato
Chromed

Fissabile anche con colla (venduta a parte)
 Can be fixed with glue (sold separately)
 Peut être fixé avec colle (vendu séparément)
 Kann mit Kleber fixiert werden (separat erhältlich)
 Se puede fijar con pegamento (se vende por separado)
 Может быть закреплен клеем (продается отдельно)

EV10 6,8 x 11,6 x 9,4 cm 	EV11 10,7 x 13,6 x 7 cm 	EV12 10,7 x 10,3 x 7 cm Inamovibile - Fixed 	EV80 6,8 x 11,7 x 15 cm
--	---------------------------------------	--	---------------------------------------

EV21/35 35 x 7 x 7 cm 	EV21/45 45 x 7 x 7 cm 	EV21/60 60 x 7 x 7 cm
-------------------------------------	-------------------------------------	-------------------------------------

ACCORCIABILE 10/35 SHORTENABLE
 ACCORCIABILE 10/45 SHORTENABLE
 ACCORCIABILE 10/60 SHORTENABLE

EV23 38 x 3,1 x 7 cm 	EV70 16 x 3,1 x 19 cm 	EV33/O3 11,7 x 13,9 x 33,5 cm
------------------------------------	-------------------------------------	---

EV24 15,9 x 7,3 x 7 cm 	EV25 12,8 x 9,2 x 10,9 cm 	EV26 6,8 x 5,3 x 7 cm 	
--------------------------------------	---	-------------------------------------	--



G•K2

Novità - New

13

Cromato
Chromed

Realizzata in Cromall® con contenitori in vetro satinato
 Made of Cromall® with frosted glass containers
 Réalisée en Cromall® avec boîtiers en verre satiné
 Hergestellt aus Cromall® mit Behältern aus satiniertem Glas
 Realizada en Cromall® con contenedores en cristal satinado
 Изготовлено из Cromall® с ёмкостями из матового стекла



Fissabile anche con colla (venduta a parte)
 Can be fixed with glue (sold separately)
 Peut être fixé avec colle (vendu séparément)
 Kann mit Kleber fixiert werden (separat erhältlich)
 Se puede fijar con pegamento (se vende por separado)
 Может быть закреплен клеем (продается отдельно)

KD10

11,7 x 8,7 x 10,3 cm



KD12

11,7 x 8,7 x 4,6 cm

Inamovibile - Fixed



KD21/45

44,7 x 8,3 x 4,8 cm



KD21/60

59,7 x 8,3 x 4,8 cm



KD70

15,7 x 4,5 x 17,6 cm



KD24

16,5 x 8,3 x 4,8 cm



KD26

5,6 x 4,1 x 4,7 cm





G•GENZIANA

Realizzata in acciaio e Cromall® con contenitori in vetro satinato
 Made of steel and Cromall® with frosted glass containers
 Réalisée en acier et Cromall® avec boîtiers en verre satiné
 Hergestellt aus Stahl und Cromall® mit Behältern aus satiniertem Glas
 Realizada en acero y Cromall® con contenedores en cristal satinado
 Изготовлено из стали и Cromall® с ёмкостями из матового стекла

13

Cromato
Chromed

02

Bianco
White

GE10

6,7 x 11 x 9,5 cm



GE11

10,8 x 13 x 3,8 cm



GE80

7,5 x 11,5 x 17 cm



13

Disponibile
solo in cromato
Available only
in chromed

GE19/55

52 x 13 x 6 cm

8,5
kgVetro temperato - tempered glass
Verre tempéré - Sekuritglas
Cristal templado - Закаленное стекло

13

Disponibile
solo in cromato
Available only
in chromed

GE21/35

39,2 x 5,5 x 3,8 cm



GE21/45

45 x 5,5 x 3,8 cm



GE21/60

57,5 x 5,5 x 3,8 cm





13

Cromato
Chromed

02

Bianco
White

GE70

16 x 5,7 x 17 cm



GE26

6,5 x 5,5 x 3,8 cm



GE24

16,6 x 6,5 x 3,8 cm



GE33

ø 7,5 x 33 cm





G•HOT

Realizzata in metallo e resine termoplastiche
 Made of metal and thermoplastic resins
 Réalisée en métal and thermoplastique
 Hergestellt aus Metall und Kunststoff
 Realizada en metal y resinas termoplásticas
 Изготовлено из металла и термопластичных смол

13

Cromato
Chromed



Solo su superfici lisce (specchi, piastrelle)
 For flat surfaces (mirrors, tiles) only
 Fissaggio con ventosa - Suction cup fixing
 Fixation avec ventouses - Befestigung mit Saugnäpfen
 Fijación con ventosas - Крепление при помощи присосок



HO20	HO80	HO21/30
-------------	-------------	----------------

27,5 x 13,6 x 12 cm

19 x 19 x 10 cm

28,2 x 5,5 x 15,3 cm



HO70	HO24	HO26
-------------	-------------	-------------

16 x 4 x 22 cm

16 x 6 x 15,5 cm

6,3 x 4,5 x 10,8 cm



HO08	HO52
-------------	-------------

15 x 27 max x 22 cm

10,7 x 12 x 22 cm





02

Bianco
White100%
made in Italy

G•DARIOS

Realizzata in resine termoindurenti
 Made of thermosetting resins
 Réalisée en thermodurcissable
 Hergestellt aus Duroplast
 Realizada en resinas termoestables
 Изготовлено из термореактивных смол

7210

18 x 11,5 x 10 cm



7211

18 x 11,5 x 3,5 cm



7218

32 x 11,5 x 3,5 cm



7221/30

32 x 11,5 x 3,5 cm



7221/60

60 x 11,5 x 3,5 cm



7219/60

60 x 11,5 x 3,5 cm

6,5
kg

7224

18 x 11,5 x 3,5 cm



7225

14 x 15 x 12 cm

resine termoplastiche - thermoplastic resins
 thermoplastique - Kunststoff - resinas
 termoplásticas - Термопластичные смолы



7226

15 x 6 x 5 cm



8034

ø 12,5 x 37,5 cm

resine termoplastiche
 thermoplastic resins
 thermoplastique
 Kunststoff
 resinas termoplásticas
 Термопластичные смолы

Design:
 Gianpietro
 Tonetti





02

Bianco
White100%
made in Italy

G•2900

Design Makio Hasuike

Realizzata in resine termoplastiche
 Made of thermoplastic resins
 Réalisée en thermoplastique
 Hergestellt aus Kunststoff
 Realizada en resinas termoplásticas
 Изготовлено из термопластичных смол

2910

15 x 12,5 x 8,5 cm



2911

15 x 12,5 x 4,5 cm



2919/45

44,5 x 12 x 2,6 cm

6,5
kg

2919/60

66 x 14 x 4,6 cm

5,5
kg

2921/30

30 x 7 x 4,6 cm



2921/60

60 x 7 x 4,6 cm



2970

24,5 x 7 x 13 cm





G•2900

Design Makio Hasuike

02

Bianco
White100%
made in Italy

2924

17 x 12,5 x 5,7 cm



2925

14,5 x 13 x 12 cm



6027

4,9 x 4,2 x 10,5 cm



5027

4,5 x 4,5 x 8 cm



2033

ø 15 x 33,5 cm

GEDY
ICON
ITEM45TH
ANNIVERSARY**MoMA** June 27, 1977
In permanent Design Collection
of the Museum of Modern Art
in New York

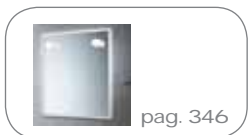

G•JUNIOR

Design Gianpietro Tonetti

Realizzata in resine termoplastiche

Made of thermoplastic resins - Réalisée en thermoplastique
Hergestellt aus Kunststoff - Realizada en resinas termoplásticas

Изготовлено из термопластичных смол

02

Bianco
White

100%
made in Italy



* Fissaggio con biadesivo o viti

To be fixed with double-sided adhesive tape or screws

Fixation avec adhésif double face ou vis - Befestigung mit doppelseitigem - Klebeband oder Schrauben

Fijación con adhesivo de dos caras o tornillos - Крепление при помощи двухсторонней клейкой ленты или шурупов



** Fissaggio con ventose o viti

To be fixed with suction cups or screws

Fixation avec ventouses ou vis - Befestigung mit Saugnapfen oder Schrauben

Fijación con ventosas o tornillos - Крепление при помощи присосок или шурупов

8010**

15 x 12 x 6,5 cm



8011**

15 x 12 x 4 cm



8012**

30 x 12 x 4 cm



8019/60**

60 x 12 x 4 cm



8080**

19,6 x 15,6 x 3 cm

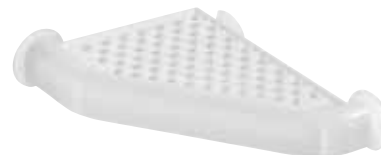

8021/30**

30 x 10 x 4 cm



8021/55**

55 x 10 x 4 cm



G•JUNIOR

Design Gianpietro Tonetti

02

Bianco
White

100%
made in Italy



8023 *

40 x 3,2 x 15,7 cm



8024 **

15 x 10,6 x 4 cm



8026 *

2,8 x 2,6 x 6 cm



8028 **

19,9 x 6,5 x 3 cm



8033

ø 13,5 x 39 cm



8034

ø 12,5 x 37,5 cm





G•VESUVIO

Realizzata in resine termoplastiche
 Made of thermoplastic resins
 Réalisée en thermoplastique
 Hergestellt aus Kunststoff
 Realizada en resinas termoplásticas
 Изготовлено из термопластичных смол

02

Bianco
 White



Solo su superfici lisce (specchi, piastrelle)
 For flat surfaces (mirrors, tiles) only

Fissaggio con ventosa - Suction cup fixing
 Fixation avec ventouses - Befestigung mit Saugnäpfen
 Fijación con ventosas - Крепление при помощи присосок



VS11

11,3 x 7,8 x 11 cm



VS21 30

30-53 x 3 x 9,5 cm



VS70

18 x 3 x 16 cm



VS28

5,5 x 3 x 11 cm



VS26

11,3 x 3 x 11 cm



VS24

17 x 3 x 15 cm



VS25

15 x 3 x 17 cm



G•MINDY

Design: R. & S. Prodotto Gedy

02

Bianco
White

Realizzata in resine termoplastiche
Made of thermoplastic resins
Réalisée en thermoplastique
Hergestellt aus Kunststoff
Realizada en resinas termoplásticas
Изготовлено из термопластичных смол



Possibile fissaggio con biadesivo (venduto a parte)
Can be fixed with double-sided (sold separately)
Peut être fixé avec adhésif double (vendu séparément)
Kann mit Klebstoff fixiert (separat erhältlich)
Se puede fijar con adhesivo de dos caras (se vende por separado)
Может быть при помощи двухсторонней
клеякой ленты (продается отдельно)

8410

13,3 x 9 x 10,4 cm



8411

13,3 x 9 x 3,5 cm



8421 / 30

33,4 x 9 x 3,5 cm



8421 / 50

53,4 x 9 x 3,5 cm



8424

16 x 9 x 3,5 cm



8426

9,3 x 5,6 x 4,1 cm



TABLE TOP



G•ALTEA

Realizzata in bambù
 Made of bamboo
 Réalisée en bambou
 Hergestellt aus Bambus
 Realizada en bambú
 Изготовлено из бамбука

35

Naturale
 Natural



AL98

ø 7 x 12 cm



AL11

ø 11,7 x 2 cm



AL80

ø 7 x 17,2 cm



AL33

ø 8,5 x 47,5 cm



G•ERICA

Realizzata in legno e acciaio
 Made of wood and steel
 Réalisée en bois et acier
 Hergestellt aus Holz und Stahl
 Realizada en madera y acero
 Изготовлено из дерева и стали

30

Noce
 Walnut
 colour



ER98

ø 7,1 x 11 cm



ER11

ø 11,5 x 1,9 cm



ER81

ø 7,2 x 16,4 cm



ER33

ø 8,9 x 36 cm



G•BAMBÙ

Realizzata in bambù
 Made of bamboo
 Réalisée en bambou
 Hergestellt aus Bambus
 Realizada en bambú
 Изготовлено из бамбука

35

Naturale
 Natural



BA98

7,4 x 7,4 x 11 cm



BA11

13,4 x 9,6 x 2,5 cm



BA81

7,4 x 7,4 x 16,8 cm



BA33

10 x 10 x 36,5 cm



G•NEMESIA

Realizzata in acciaio inox
 Made of stainless steel
 Réalisée en acier inoxydable
 Hergestellt aus Edelstahl
 Realizada en acero inox
 Изготовлено из нержавеющей стали

13

Cromato
 Chromed



NE98

6 x 6 x 10 cm



NE11

11,8 x 11,8 x 2 cm



NE81

6 x 6 x 18 cm



NE33

9 x 9 x 38 cm



NE33 O3

9 x 9,5 x 38 cm



G•NIKITA

Realizzata in acciaio inox

Made of stainless steel

Réalisée en acier inoxydable

Hergestellt aus Edelstahl

Realizada en acero inox

Изготовлено из нержавеющей стали

38

Finitura
spazzolata
Brushed
finishing

85

Antracite
Anthracite



NK98

7 x 7 x 11 cm



NK11

13 x 10 x 2,5 cm



NK80

7 x 10 x 14 cm



NK33

10,5 x 10,5 x 43,5 cm



G•ELETTRA

Realizzata in acciaio inox
 Made of stainless steel
 Réalisée en acier inoxydable
 Hergestellt aus Edelstahl
 Realizada en acero inox

15
 Rame
 Copper

Изготовлено из нержавеющей стали



EE98

ø 6,3 x 11,3 cm



EE11

11 x 8 x 2 cm



EE80

ø 6,3 x 19 cm



EE33

ø 8 x 46,8 cm



G•POLARIS

Realizzata in acciaio inox
 Made of stainless steel
 Réalisée en acier inoxydable
 Hergestellt aus Edelstahl
 Realizada en acero inox
 Изготовлено из нержавеющей стали

13

Cromato
 Chromed



PL98

10,2 x 4,5 x 10 cm



PL11

12,6 x 10,2 x 2,5 cm



PL80

10,2 x 4,5 x 15,3 cm



PL33

12,5 x 9,5 x 39,4 cm



G•PRIMULA

Realizzata in acciaio inox
 Made of stainless steel
 Réalisée en acier inoxydable
 Hergestellt aus Edelstahl
 Realizada en acero inox

Изготовлено из нержавеющей стали

21

lucida/
 spazzolata
 polished/
 brushed



PR98

ø 7 x 10 cm



PR11

ø 11,2 x 2 cm



PR80

ø 5,5 x 19 cm



PR33

ø 10 x 38 cm



G•NIGELLA

Realizzata in acciaio inox
 Made of stainless steel
 Réalisée en acier inoxydable
 Hergestellt aus Edelstahl
 Realizada en acero inox
 Изготовлено из нержавеющей стали

38

Spazzolata
 Brushed



NI98

ø 9 x 10 cm



NI11

ø 11 x 2,1 cm



NI81

ø 9 x 15,5 cm



NI33

ø 13 x 39 cm



Novità - New

G•MARINA

Realizzata in ceramica e madreperla

Made of pottery and conch

Réalisée en céramique et nacre

Hergestellt aus Keramik und Perlmutter

Realizada en cerámica y nácar

Изготовлено из керамики и перламутра

03

Crema
Cream



MR98

ø 8,5 x 11,3 cm



MR11

14 x 10 x 3,9 cm



MR80

ø 8,5 x 19 cm



MR33

ø 12,5 x 46 cm



G•MYOSOTIS

Realizzata in ceramica e vetro

Made of pottery and glass

Réalisée en céramique et verre

Hergestellt aus Keramik und Glas

Realizada en cerámica y cristal

Изготовлено из керамики и стекла



03
Crema/
oro
Cream/
gold



73
Grigio/
argento
Grey/
silver



MY98

ø 8,5 x 11,3 cm



MY11

14 x 10 x 3,9 cm



MY80

ø 8,5 x 19 cm



MY33

ø 12,5 x 46 cm



G•LUCREZIA

Realizzata in ceramica
 Made of pottery
 Réalisée en céramique
 Hergestellt aus Keramik
 Realizada en cerámica
 Изготовлено из керамики

02

Bianco
 White



LC98

7 x 7 x 11 cm



LC11

13 x 10 x 2,2 cm



LC80

7 x 7 x 17,5 cm



LC33

10 x 10 x 46 cm



G•LUCY

Realizzata in ceramica
 Made of pottery
 Réalisée en céramique
 Hergestellt aus Keramik
 Realizada en cerámica
 Изготовлено из керамики

02

Bianco
 White



LY98

7,3 x 7,3 x 10,3 cm



LY11

12 x 8,2 x 3 cm



LY80

7,3 x 7,3 x 17,5 cm



LY33

9,7 x 9,7 x 47 cm



G•RITA

Realizzata in ceramica
 Made of pottery
 Réalisée en céramique
 Hergestellt aus Keramik
 Realizada en cerámica
 Изготовлено из керамики

02

Bianco
 White



RI98

ø 7 x 10,5 cm



RI11

13 x 9,5 x 3,5 cm



RI80

ø 7 x 17 cm



RI33

ø 9 x 45 cm



G•NEW MIZAR

Realizzata in ceramica
 Made of pottery
 Réalisée en céramique
 Hergestellt aus Keramik
 Realizada en cerámica
 Изготовлено из керамики



NM98

ø 6,4 x 10,8 cm



NM11

12,3 x 9 x 3 cm



NM80

ø 6,4 x 19,2 cm



NM33

ø 9,7 x 47,5 cm



08

Grigio
Grey

52

Tortora
Turtledove
grey

66

Tortora
chiaro
Light
turtledove
grey



G•ASTRID

Realizzata in ceramica
 Made of pottery
 Réalisée en céramique
 Hergestellt aus Keramik
 Realizada en cerámica
 Изготовлено из керамики

73

Argento
Silver

87

Oro
Gold

AD98

ø 8,3 x 11 cm



AD11

ø 12 x 2,6 cm



AD80

ø 8,3 x 16,6 cm



AD33

ø 11,5 x 47 cm



G•NEW MARTINA

Realizzata in ceramica
 Made of pottery
 Réalisée en céramique
 Hergestellt aus Keramik
 Realizada en cerámica
 Изготовлено из керамики

02

Bianco
 White

73

Argento
 Silver



MT 98

7,5 x 7,5 x 11 cm



MT 11

13 x 9 x 2,3 cm



MT 80

7,5 x 7,5 x 16 cm



MT 33

9 x 9 x 47 cm



G•ILARY

Realizzata in ceramica e sughero

Made of pottery and cork

Réalisée en céramique et liège

Hergestellt aus Keramik und Kork

Realizada en cerámica y corcho

Изготовлено из керамики и пробки

02

Bianco
White

14

Nero
Black



IL98

ø 7 x 10,5 cm



IL11

13 x 9,5 x 3 cm



IL80

ø 7 x 17 cm



IL33

ø 8,8 x 46,5 cm



G•NAOMI

Realizzata in ceramica
 Made of pottery
 Réalisée en céramique
 Hergestellt aus Keramik
 Realizada en cerámica
 Изготовлено из керамики

08

Grigio
 Grey

14

Nero
 Black



NO98

ø 7,5 x 11,5 cm



NO11

13 x 9 x 2,5 cm



NO80

ø 7,5 x 18,5 cm



NO33

ø 9 x 45,5 cm



G•SABINA

Realizzata in ceramica
 Made of pottery
 Réalisée en céramique
 Hergestellt aus Keramik
 Realizada en cerámica
 Изготовлено из керамики

27

Acquamarina
 Aquamarine



SA98

ø 7,5 x 11 cm



SA11

ø 12 x 2 cm



SA80

ø 7,5 x 19 cm



SA33

ø 9,3 x 46 cm



G•CHANTAL

Realizzata in ceramica
 Made of pottery
 Réalisée en céramique
 Hergestellt aus Keramik
 Realizada en cerámica
 Изготовлено из керамики

14

Nero
 Black



CN98

ø 7 x 12 cm



CN11

12,8 x 8,3 x 2,5 cm



CN80

ø 7 x 20,6 cm



CN33

ø 11,5 x 46,5 cm



G•MARIKA

Realizzata in ceramica
 Made of pottery
 Réalisée en céramique
 Hergestellt aus Keramik
 Realizada en cerámica
 Изготовлено из керамики



MK98

ø 8 x 11,6 cm



MK11

12 x 8,3 x 3 cm



MK80

ø 8 x 18 cm



MK33

ø 10,2 x 45 cm



02

Bianco
White

07

Verde
salvia
Green
sage

08

Grigio
Grey



G•AZALEA

Realizzata in ceramica
 Made of pottery
 Réalisée en céramique
 Hergestellt aus Keramik
 Realizada en cerámica
 Изготовлено из керамики



AZ98

ø 9,8 x 13 cm



AZ11

12,4 x 9 x 2,7 cm



AZ80

ø 10,2 x 17 cm



AZ33

ø 16,5 x 40,3 cm



02

Bianco
White

05

Blu
Blue

79

Lilla
Lilac



G•CATHERINE

Realizzata in ceramica
 Made of pottery
 Réalisée en céramique
 Hergestellt aus Keramik
 Realizada en cerámica
 Изготовлено из керамики

02

Bianco
 White



CT98

ø 7,7 x 12 cm



CT11

13 x 7,8 x 1,8 cm



CT80

ø 7,7 x 19 cm



CT33

ø 9,8 x 40 cm



G•AMELIE

Realizzata in ceramica
 Made of pottery
 Réalisée en céramique
 Hergestellt aus Keramik
 Realizada en cerámica
 Изготовлено из керамики

02

Bianco
 White



AM98

8 x 8 x 11,3 cm



AM11

13,5 x 8 x 5,8 cm



AM80

7,5 x 7,5 x 19 cm



AM33

10,4 x 10,4 x 48,5 cm



G•CLOTHILDE

Realizzata in ceramica
 Made of pottery
 Réalisée en céramique
 Hergestellt aus Keramik
 Realizada en cerámica
 Изготовлено из керамики

02

Bianco
 White



CI98

ø 7,2 x 11,8 cm



CI11

12,7 x 8,8 x 2,9 cm



CI80

ø 7,2 x 20 cm



CI33

ø 9,6 x 46 cm



G•VIVIENNE

Realizzata in ceramica
 Made of pottery
 Réalisée en céramique
 Hergestellt aus Keramik
 Realizada en cerámica
 Изготовлено из керамики

02
 Bianco
 White

05
 Blu
 Blue



VV98

9,5 x 6 x 10,5 cm



VV11

13 x 8,4 x 3,2 cm



VV80

8,7 x 6 x 18 cm



VV33

9 x 9 x 47 cm



G•VERBENA

Realizzata in ceramica
 Made of pottery
 Réalisée en céramique
 Hergestellt aus Keramik
 Realizada en cerámica
 Изготовлено из керамики

02

Bianco
 White



VE98

6,5 x 6,5 x 10 cm



VE11

11,5 x 8,5 x 2,5 cm



VE81

6,5 x 6,5 x 16,5 cm



VE33

cm 7,8 x 7,8 x 45,6



G•DALIA

Realizzata in ceramica
 Made of pottery
 Réalisée en céramique
 Hergestellt aus Keramik
 Realizada en cerámica
 Изготовлено из керамики

02

Bianco
 White



DA98

ø 8,1 x 10,6 cm



DA11

ø 12,5 x 3,2 cm



DA80

ø 9 x 17,8 cm



DA33

ø 12,5 x 38 cm



G•PETUNIA

Realizzata in ceramica e acciaio inox
 Made of pottery and stainless steel
 Réalisée en céramique et acier inoxydable
 Hergestellt aus Keramik und Edelstahl
 Realizada en cerámica y acero inox
 Изготовлено из керамики и нержавеющей стали

02

Bianco
 White



PE98

ø 7,5 x 9,5 cm



PE11

12,5 x 8,5 x 3,5 cm



PE81

ø 7,5 x 16,5 cm



PE33

ø 9 x 44,8 cm



G•GINEVRA

Serie in cemento
 Made of concrete
 Réalisée en béton
 Hergestellt aus Zement
 Realizada en cemento
 Изготовлено из бетона

08

Grigio
 Grey



GN98

ø 7 x 10 cm



GN11

12,6 x 8 x 2 cm



GN80

ø 7 x 15,8 cm



GN33

ø 10 x 46,7 cm



G•NORA

Realizzata in resina e bambù
 Made of resin and bamboo
 Réalisée en résine et bambou
 Hergestellt aus Harz und Bambus
 Realizada en resina y bambú
 Изготовлено из бамбука и смол

08

Grigio
Grey

NR98

8,5 x 8,5 x 12 cm



NR11

13 x 8,5 x 2,5 cm



NR80

9,8 x 4,6 x 14,6 cm



NR33

10,5 x 10,5 x 46 cm



Novità - New

G•SOFIA

Realizzata in resina e sabbia
 Made of resin and sand
 Réalisée en résine et sable
 Hergestellt aus Harz und Sand
 Realizada en resina y arena
 Изготовлено из смол и песка

02

Bianco
 lucido
 Lacquered
 white

14

Nero matt
 Matt
 black



SF98

7,4 x 7,4 x 11 cm



SF11

10,9 x 6,9 x 2,9 cm



SF80

7,3 x 8,4 x 17,3 cm



SF33

9,4 x 9,4 x 47,2 cm



G•ARIES

Realizzata in resina e sabbia
 Made of resin and sand
 Réalisée en résine et sable
 Hergestellt aus Harz und Sand
 Realizada en resina y arena
 Изготовлено из смол и песчаника

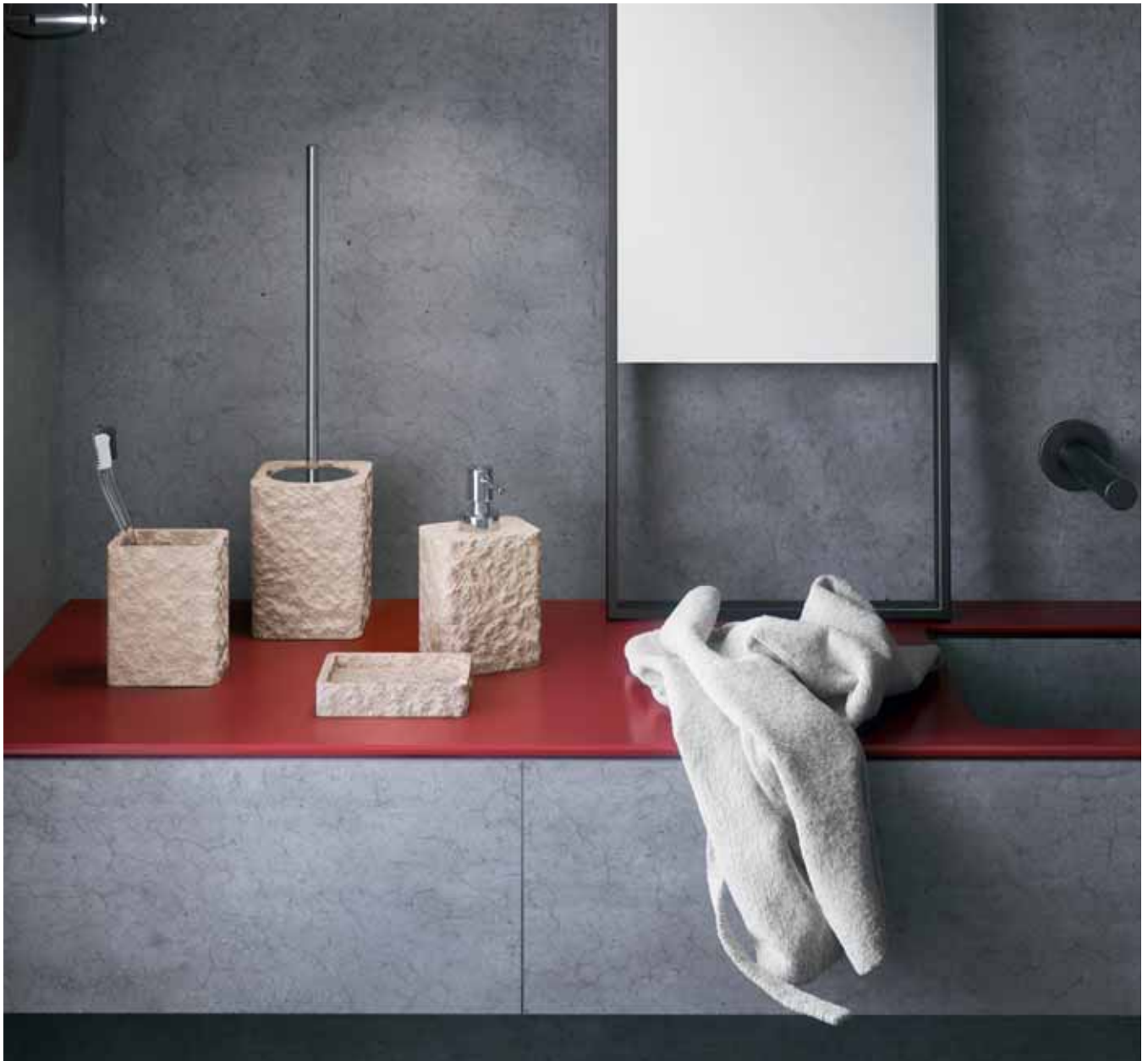

AR98

9,2 x 6,5 x 11 cm



AR11

12,2 x 8,6 x 2,4 cm



AR80

9 x 6,4 x 16,8 cm



AR33

10,5 x 10,5 x 40 cm



03

Beige

08

Grigio
Grey

85

Antracite
Anthracite



G•LIBRA

Realizzata in resina e sabbia
 Made of resin and sand
 Réalisée en résine et sable
 Hergestellt aus Harz und Sand
 Realizada en resina y arena
 Изготовлено из смол и песчаника

03

Beige



LB98

8,2 x 8,4 x 10,4 cm



LB11

14,7 x 14 x 3,2 cm



LB81

9,6 x 10,7 x 17,5 cm



LB33

12,1 x 12,5 x 41,6 cm



G•AQUARIUS

Realizzata in resina
 Made of resin
 Réalisée en résine
 Hergestellt aus Harz
 Realizada en resina
 Изготовлено из смол

03

Beige



AQ98

8,5 x 8,5 x 10,3 cm



AQ11

12,7 x 12,7 x 2,8 cm



AQ80

8,9 x 8,6 x 18 cm



AQ33

10,9 x 10,7 x 40 cm



G•GEMINI

Realizzata in resina
 Made of resin
 Réalisée en résine
 Hergestellt aus Harz
 Realizada en resina
 Изготовлено из смол



GM98

ø 8,7 x 11,1 cm



GM11

14 x 9,6 x 2,8 cm



GM80

8,6 x 9,4 x 20,7 cm



GM33

ø 9,9 x 45,7 cm



02

Bianco
White

08

Grigio
Grey

52

Tortora
Turtledove
grey



G•ETNICA

Realizzata in resina
 Made of resin
 Réalisée en résine
 Hergestellt aus Harz
 Realizada en resina
 Изготовлено из смол

29

Moka



ET98

8 x 8 x 10,4 cm



ET11

12,6 x 8,2 x 2,2 cm



ET81

7,9 x 7,9 x 15,7 cm



ET33

10 x 10 x 36 cm



G•PETRA

Realizzata in resina
 Made of resin
 Réalisée en résine
 Hergestellt aus Harz
 Realizada en resina
 Изготовлено из смол

08

Grigio
 Grey



PT98

ø 7,5 x 11 cm



PT11

13,7 x 10 x 2,4 cm



PT80

ø 7,5 x 15,8 cm



PT33

ø 9 x 44,5 cm



G•QUADROTTO

Realizzata in resina
 Made of resin
 Réalisée en résine
 Hergestellt aus Harz
 Realizada en resina
 Изготовлено из смол



QU98

10 x 6,5 x 11,2 cm



QU11

11,2 x 11,2 x 2,4 cm



QU81

8,2 x 8,2 x 16 cm



QU33

9,5 x 9,5 x 46 cm



02

Bianco
White

08

Grigio
Grey

14

Nero
Black

66

Tortora
chiaro
Light
turtledove
grey



G•SOLE

Realizzata in resina
 Made of resin
 Réalisée en résine
 Hergestellt aus Harz
 Realizada en resina
 Изготовлено из смол



SL98

ø 7,2 x 12,2 cm



SL11

ø 11 x 2,9 cm



SL80

ø 7,2 x 15,7 cm



SL33

ø 9,8 x 40 cm



- 11 Azzurro Light blue
- 63 Viola Purple
- 67 Arancio Orange



G•IDRA

Realizzata in resina
 Made of resin
 Réalisée en résine
 Hergestellt aus Harz
 Realizada en resina
 Изготовлено из смол

03

Beige



ID98

ø 10,2 x 10,4 cm



ID11

12,3 x 9 x 2,7 cm



ID80

ø 10,6 x 15,5 cm



ID33

ø 12,2 x 40 cm



G•OLIMPIA

Realizzata in resina
 Made of resin
 Réalisée en résine
 Hergestellt aus Harz
 Realizada en resina
 Изготовлено из смол

73
 Argento
 Silver

87
 Oro
 Gold



OM98

ø 7,5 x 11 cm



OM11

13,8 x 9,5 x 2,2 cm



OM80

ø 7,5 x 19,6 cm



OM33

ø 9,5 x 45 cm



Novità - New

G•DORI

Realizzata in resina
 Made of resin
 Réalisée en résine
 Hergestellt aus Harz
 Realizada en resina
 Изготовлено из смол

92

Turchese
 Turquoise



DR98

ø 8,6 x 10,6 cm



DR11

17,5 x 11,7 x 1,7 cm



DR80

13,6 x 10,2 x 16,4 cm



DR33

11,3 x 9,5 x 37,8 cm



G•GRAZIA

Realizzata in resina
 Made of resin
 Réalisée en résine
 Hergestellt aus Harz
 Realizada en resina
 Изготовлено из смол

02

Bianco
 White



GR98

ø 8 x 10,6 cm



GR11

13,8 x 9,5 x 2,8 cm



GR80

12 x 7,3 x 17 cm



GR33

ø 11 x 46,7 cm



G•SELINA

Realizzata in resina
 Made of resin
 Réalisée en résine
 Hergestellt aus Harz
 Realizada en resina
 Изготовлено из смол



Multicolore
 Multicolor



SE98

13 x 7,8 x 10 cm



SE11

12,5 x 9,7 x 1,6 cm



SE80

ø 8 x 18 cm



SE33

ø 9,5 x 47 cm



G•TWIST

Design: Babled & Co.

S2

Bianco
White

73

Argento
Silver

79

Lilla
Lilac

Realizzata in resina
Made of resin
Réalisée en résine
Hergestellt aus Harz
Realizada en resina
Изготовлено из смол



4698

8,5 x 8,5 x 12 cm



4611

13 x 9 x 3,5 cm



4681

8,5 x 8,5 x 17,5 cm



4633

12 x 13,5 x 47 cm



G•CHANELLE

Realizzata in resina
 Made of resin
 Réalisée en résine
 Hergestellt aus Harz
 Realizada en resina
 Изготовлено из смол



CH98

9 x 7 x 10,5 cm



CH11

12 x 7,8 x 2,8 cm



CH80

11,5 x 7,8 x 12,6 cm



CH33

10,6 x 8,6 x 45,7 cm



02

Bianco
White

07

Verde
menta
Green
mint

10

Rosa
Pink

37

Pesca
Peach
color

66

Tortora
chiaro
Light
turtledove
grey



G•ANTARES

Realizzata in resina
 Made of resin
 Réalisée en résine
 Hergestellt aus Harz
 Realizada en resina
 Изготовлено из смол



AT98

8 x 6,2 x 11,7 cm



AT11

11,2 x 7,5 x 2,7 cm



AT80

8 x 6,2 x 15,5 cm



AT33

8,7 x 8 x 47 cm



T2

Bianco
White

T5

Blu
Blue

T6

Marrone
Brown

T8

Grigio
Grey



G•RAINBOW

Realizzata in resina
 Made of resin
 Réalisée en résine
 Hergestellt aus Harz
 Realizada en resina
 Изготовлено из смол



RA00

19 x 11 x 7,5 cm



RA98

7,2 x 7,2 x 11 cm



RA11

11 x 7 x 3 cm



RA81

7 x 7 x 16,2 cm



RA33

9,8 x 9,8 x 37,5 cm



- 02**

Bianco
White
- 04**

Verde acido
Acid green
- 05**

Blu
Blue
- 06**

Rosso
Red
- 14**

Nero
Black
- 67**

Arancio
Orange
- 73**

Argento
Silver
- 79**

Lilla
Lilac
- 52**

Tortora
Turtledove
grey
- 66**

Tortora chiaro
Light
turtledove
grey



RA80 RA02 RA08

7 x 11,3 x 17,2 cm 14,5 x 14,5 x 15 cm 25 x 13,5 x 7,5 cm

- 02**

Bianco
White
- 04**

Verde acido
Acid green
- 05**

Blu
Blue
- 06**

Rosso
Red
- 14**

Nero
Black
- 67**

Arancio
Orange
- 73**

Argento
Silver
- 79**

Lilla
Lilac



G•GIULIA

Realizzata in resina
 Made of resin
 Réalisée en résine
 Hergestellt aus Harz
 Realizada en resina
 Изготовлено из смол

T2

Bianco
 White

T6

Marrone
 Brown



GU98

7 x 7 x 11 cm



GU11

10,6 x 6,8 x 2 cm

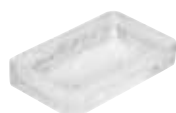

GU80

7 x 7 x 16 cm



GU33

9,2 x 9,2 x 46 cm



G•VEGA

Realizzata in resina
 Made of resin
 Réalisée en résine
 Hergestellt aus Harz
 Realizada en resina
 Изготовлено из смол

02

Bianco
 White

73

Argento
 Silver



VG98

ø 7 x 12 cm



VG11

ø 11 x 2,5 cm



VG80

ø 7 x 15,7 cm



VG33

ø 10 x 37 cm



G•FLOU

Design: Carallo_Grandis

02

Bianco
White

05

Turchese
trasparente
Transparent
turquoise

Realizzata in resine termoplastiche
Made of thermoplastic resins
Réalisée en thermoplastique
Hergestellt aus Kunststoff
Realizada en resina termoplásticas
Изготовлено из термопластичных смол



1798

ø 10,2 x 11,2 cm



1711

13,8 x 12,5 x 4 cm



1780

ø 11 x 19 cm



1733

ø 12,6 x 36 cm





73

Argento
Silver

G•LUNA

Realizzata in resine termoplastiche
 Made of thermoplastic resins
 Réalisée en thermoplastique
 Hergestellt aus Kunststoff
 Realizada en resina termoplásticas
 Изготовлено из термопластичных смол



LU98

ø 7,2 x 12,9 cm



LU11

ø 11,5 x 2,4 cm



LU80

ø 7,2 x 15,2 cm



LU33

ø 8,7 x 47 cm



G•GLADY

Realizzata in resine termoplastiche
 Made of thermoplastic resins
 Réalisée en thermoplastique
 Hergestellt aus Kunststoff
 Realizada en resina termoplásticas
 Изготовлено из термопластиченых смол



GL98

ø 8,5 x 11 cm



GL11

12,3 x 8 x 2,5 cm



GL80

ø 8,5 x 17 cm



GL33

ø 13,2 x 40,5 cm



00	02	05	29	67	76	79	85	92
Trasparente Transparent	Bianco White	Blu Blue	Moka Moka	Arancio Orange	Fucsia Fuchsia	Lilla Lilac	Antracite Anthracite	Turchese Turquoise

NEW

04
Verde acido Acid green



GLOO

18,5 x 10,5 x 7,5 cm

00Trasparente
Transparent

pag. 358

G•SEVENTY

Design: Matteo Thun ✦

Realizzata in resine termoplastiche
 Made of thermoplastic resins
 Réalisée en thermoplastique
 Hergestellt aus Kunststoff
 Realizada en resina termoplásticas
 Изготовлено из термопластиченых смол



6398

6,5 x 6,5 x 12,2 cm



6311

12,4 x 8 x 2,1 cm



6382

6,5 x 6,5 x 16 cm



6334

9 x 9 x 38,8 cm



- 08**
Grigio
Grey
- 22**
Bianco
White
- 52**
Tortora
Turtledove
grey
- 79**
Lilla
Lilac
- 66**
Beige
Beige

NEW

- V7**
Verde
pistacchio
Pistachio
green

100%
made in Italy



G•MOBY

Realizzata in resine termoplastiche
 Made of thermoplastic resins
 Réalisée en thermoplastique
 Hergestellt aus Kunststoff
 Realizada en resina termoplásticas
 Изготовлено из термопластиченых смол



3198

8,7 x 8,3 x 11,5 cm



3111

15 x 12 x 5,5 cm



3182

8,7 x 8,3 x 16,5 cm



3133

11,1 x 10,9 x 37,8 cm

100%
made in Italy





02
Bianco
White



48
Bianco/
tortora
White/
turtledove



58
Bianco/
Tortora chiaro
White/light
turtledove
grey



71
Bianco/
grigio
White/
grey



89
Bianco/
blu
White/
blue



Novità - New

G•PIXIS

Realizzata in resine termoplastiche

Made of thermoplastic resins

Réalisée en thermoplastique

Hergestellt aus Kunststoff

Realizada en resina termoplásticas

Изготовлено из термопластиченых смол



Bianco/
blu
White/
blue



PY10

ø 7,2 x 12 cm



PY11

11 x 7,6 x 3,3 cm



PY80

ø 7 x 18,5 cm



PY33

ø 10,2 x 35 cm



BEAUTY



Specchi senza luci

Mirrors without lights - Miroirs sans éclairage
Spiegel ohne Beleuchtung - Espejos sin luces - Зеркала без подсветки



2551 *

100 x 2 x 60 cm

Specchio filo lucido

Polished edge mirror

Miroir bord poli

Spiegel mit polierter Kante

Espejo canto pulido

Зеркало с полированными краями

100%
made in Italy



2561 *

100 x 2 x 60 cm

Specchio bisellato

Bevelled mirror

Miroir biseauté

Spiegel mit Facettenschliff

Espejo biselado

Зеркало со скшенными краями

100%
made in Italy



* Montabile anche in posizione verticale - Can be mounted upright
Montable aussi en position verticale
Senkrecht aufhängbar auch - Puede montarse también verticalmente
Монтаж тоже в вертикальном положении



2575 *

75 x 2 x 55 cm

Specchio filo lucido

Polished edge mirror

Miroir bord poli

Spiegel mit polierter Kante

Espejo canto pulido

Зеркало с полированными краями

100%
made in Italy



2585 *

75 x 2 x 55 cm

Specchio bisellato

Bevelled mirror

Miroir biseauté

Spiegel mit Facettenschliff

Espejo biselado

Зеркало со скшенными краями

100%
made in Italy



* Montabile anche in posizione verticale - Can be mounted upright
Montable aussi en position verticale
Senkrecht aufhängbar auch - Puede montarse también verticalmente
Монтаж тоже в вертикальном положении

**2520**

ø 65 x 2 cm

Specchio filo lucido

Polished edge mirror

Miroir bord poli

Spiegel mit polierter Kante

Espejo canto pulido

Зеркало с полированными

краями

100%
made in Italy**2530**

ø 65 x 2 cm

Specchio bisellato

Bevelled mirror

Miroir biseauté

Spiegel mit Facettenschliff

Espejo biselado

Зеркало со скшенными

краями

100%
made in Italy**2540***

50 x 2 x 80 cm

2550*

60 x 2 x 70 cm

Specchio filo lucido

Polished edge mirror

Miroir bord poli

Spiegel mit polierter Kante

Espejo canto pulido

Зеркало с полированными краями

100%
made in Italy**2545***

50 x 2 x 80 cm

2560*

60 x 2 x 70 cm

Specchio bisellato

Bevelled mirror

Miroir biseauté

Spiegel mit Facettenschliff

Espejo biselado

Зеркало со скшенными краями

100%
made in Italy

* Montabile anche in posizione orizzontale - Can be mounted horizontally
 Montable aussi en position horizontale
 Kann auch quer aufgehängt werden - Puede montarse también
 horizontalmente - Монтаж тоже в горизонтальном положении

**8400 G•DAKOTA**

Design: Carlo Vietri

50 x 2 x 65 cm

100%
 made in Italy

Specchio filo lucido

Polished edge mirror

Miroir bord poli

Spiegel mit polierter Kante

Espejo canto pulido

Зеркало с полированными краями

Montabile anche in posizione orizzontale - Can be mounted horizontally
 Montable aussi en position horizontale
 Kann auch quer aufgehängt werden - Puede montarse también horizontalmente - Монтаж тоже в горизонтальном положении

**7800 G•MAINE**

60 x 3 x 70 cm

100%
 made in Italy

Specchio con bordo laccato

Mirror with lacquered frame

Miroir avec cadre laqué

Spiegel mit lackiertem Rahmen

Espejo con marco lacado

Зеркало с лакированной рамой

05Blu
Blue**67**Arancio
Orange**73**Argento
Silver**76**Fucsia
Fuchsia

Montabile anche in posizione orizzontale - Can be mounted horizontally
 Montable aussi en position horizontale
 Kann auch quer aufgehängt werden - Puede montarse también horizontalmente - Монтаж тоже в горизонтальном положении



2604

60 x 6 x 70 cm

100%
made in Italy

Specchio
Mirror
Miroir
Spiegel
Espejo
Зеркало



6000

ø 60 x 3 cm

100%
made in Italy

Specchio
Mirror
Miroir
Spiegel
Espejo
Зеркало



6004

55 x 3 x 55 cm

Specchio
 Mirror
 Miroir
 Spiegel
 Espejo
 Зеркало

100%
 made in Italy



2901

45 x 14,7 x 60 cm

Specchio con mensola
 Mirror with shelf
 Miroir avec étagère
 Spiegel mit Ablage
 Espejo con estante
 Зеркало со полочка

100%
 made in Italy



2900

45 x 4 x 45 cm

Specchio
 Mirror
 Miroir
 Spiegel
 Espejo
 Зеркало

100%
 made in Italy



8000

Design:
 Gianpietro Tonetti

55 x 3,5 x 60 cm

Specchio
 Mirror
 Miroir
 Spiegel
 Espejo
 Зеркало

100%
 made in Italy



Specchi con luci

Mirrors with lights - Miroirs avec éclairage
Spiegel mit Beleuchtung - Espejos con luces - Зеркала со светильником

Luci non incluse - Lights not included



8401 G•DAKOTA

Design: Carlo Vietri

50 x 6 x 65 cm

100%
made in Italy

Specchio filo lucido

Polished edge mirror

Miroir bord poli

Spiegel mit polierter Kante

Espejo canto pulido

Зеркало с полированными краями

CE

IP 20 

W25 - E14



2605

60 x 6,6 x 70 cm

100%
made in Italy

Specchio

Mirror

Miroir

Spiegel

Espejo

Зеркало

CE

IP 20 

W25 - E14



6001

ø 60 x 5 cm

Specchio
 Mirror
 Miroir
 Spiegel
 Espejo
 Зеркало

100%
 made in Italy

CE
 IP 20
 W25 - E14



6005

55 x 5 x 55 cm

Specchio
 Mirror
 Miroir
 Spiegel
 Espejo
 Зеркало

100%
 made in Italy

CE
 IP 20
 W25 - E14



2903

45 x 14,7 x 60 cm

Specchio con mensola

Mirror with shelf

Miroir avec étagère

Spiegel mit Ablage

Espejo con estante

Зеркало со полочка

CE

IP 20 

W25 - E14

100%
made in Italy

8001

Design:
Gianpietro Tonetti

55 x 5,5 x 60 cm

Specchio

Mirror

Miroir

Spiegel

Espejo

Зеркало

CE

IP 20 

W25 - E14

100%
made in Italy

13

Lucido
Polished

Armadietti in acciaio inox

Cabinets made of stainless steel - Armoires en acier inoxydable
Hängeschränken aus Edelstahl - Armarios en acero inox Шкаф изготовлено из нержавеющей стали

2807

51 x 11,5 x 64,5 cm

Con anta a specchio reversibile e 1 ripiano acciaio inox/vetro

With reversible mirror door and 1 shelf stainless steel/glass

Avec porte à miroir réversible et 1 étagère acier inoxydable/verre

Mit reversibler Spiegeltür und 1 Ablage Edelstahl/Glas

Con puerta de espejo reversible y 1 repisa acero inox/cristal

С реверсивной зеркальной дверцей и 1 полочка нержавеющей стали/стекла

Lampada non inclusa - Lamp not included



2806

51 x 11,5 x 60 cm

Con anta a specchio reversibile e 1 ripiano acciaio inox/vetro

With reversible mirror door and 1 shelf stainless steel/glass

Avec porte à miroir réversible et 1 étagère acier inoxydable/verre

Mit reversibler Spiegeltür und 1 Ablage Edelstahl/Glas

Con puerta de espejo reversible y 1 repisa acero inox/cristal

С реверсивной зеркальной дверцей и 1 полочка нержавеющей стали/стекла





KO07 G•KORA

46 x 12 x 66 cm

Armadietto reversibile con antina a specchio scorrevole - acciaio inox AISI 304

Cabinet with sliding mirror door in AISI 304 stainless steel

Armoire reversible avec porte à miroir coulissante acier inoxydable AISI 304

Schrankchen, reversibel, mit Spiegel-Schiebetür Edelstahl AISI 304

Armario reversible con puerta de espejo corredera - acero inox AISI 304

Шкафчик с зеркальной раздвижной дверцей нержавеющей сталь AISI 304



JO07 G•JOKER

30 x 12 x 50 cm

JO35 G•JOKER

30 x 12 x 30 cm

Armadietti con anta in vetro, serratura di sicurezza e 1 ripiano - acciaio inox/vetro

Cabinets with glass door, safety lock and 1 shelf stainless steel/glass

Armoires avec porte vitrée, serrure de sécurité et 1 étagère - acier inox/verre

Schränkchen mit Glastür, Sicherheitsschloss und 1 Ablage - Edelstahl/Glas

Armarios con puerta de cristal, cerradura de seguridad y 1 repisa - acero inoxidable/cristal

Шкафчик со стеклянной створкой, замком и 1 полочка - нержавеющая сталь/стекло

02

Bianco
White

Armadietti in resine termoplastiche

Cabinets in thermoplastic resins - Armoires en thermoplastique - Hängeschränken aus thermoplastischem Kunststoff
Armarios en resinas termoplásticas - Шкаф изготовлено из термопластичных смол



8047 G•PRINCESS

100%
made in Italy

58,5 x 14 x 38 cm

Con 3 ante a specchio

With 3 mirror doors

Avec 3 portes à miroir

Mit 3 Spiegeltüren

Con 3 puertas de espejo

С 3 зеркальными дверцами



8007 G•LILLIPUT

100%
made in Italy

Design: Olaf Von Bohr

30 x 14,3 x 45 cm

Con anta a specchio

With mirror door - Avec porte à miroir

Mit Spiegeltür - Con puerta de espejo

С зеркальной дверцей



8035

100%
made in Italy

25 x 12,5 x 39,5 cm

Armadietto farmacia con chiave

Medicine cabinet with key

Armoire à pharmacie avec clef

Arzneischrank mit Schlüssel

Botiquín con llave

Аптека закрывающаяся на ключ

Specchi ingranditori

Magnifying mirrors - Miroirs grossissants - Kosmetikspiegel
Espejos de aumento - Увеличительные зеркала



HO08 G•HOT

13

ø 15 x 27max x 22 cm

Cromato
Chromed



SOLO SU SUPERFICI LISCE (SPECCHI, PIASTRELLE)
FOR FLAT SURFACES (MIRRORS, TILES) ONLY

Specchio ingranditore e non, con fissaggio a ventosa - resine termoplastiche/metallo

Magnifying and non-magnifying mirror with suction cup fixing - thermoplastic resins/metal

Miroir grossissant et non grossissant avec ventouse thermoplastique/métal

Spiegel mit und ohne Vergrößerung - mit Saugnapf-Befestigung - Kunststoff/Metall

Espejo de aumento y normal - fijación con ventosa - resinas termoplásticas/metall

Авчстороннее чвеличительное и обычное зеркало на присоска - термопластичные смоли/металл



CO2021

13

ø 20 x 3 cm

Cromato
Chromed



SOLO SU SUPERFICI LISCE (SPECCHI, PIASTRELLE)
FOR FLAT SURFACES (MIRRORS, TILES) ONLY

Specchio ingranditore con ventose metallo/vetro

Magnifying mirror with suction cups metal/glass

Miroir grossissant avec ventouses métal/verre

Vergrößerungsspiegel mit Saugnapfen Metall/Glas

Espejo de aumento con ventosas metal/cristal

Увеличительное зеркало на присосках металл/стекло



CO2020

13

ø 15 x 3 cm

Cromato
Chromed



SOLO SU SUPERFICI LISCE (SPECCHI, PIASTRELLE)
FOR FLAT SURFACES (MIRRORS, TILES) ONLY

Specchio ingranditore con ventose metallo/vetro

Magnifying mirror with suction cups metal/glass

Miroir grossissant avec ventouses métal/verre

Vergrößerungsspiegel mit Saugnapfen Metall/Glas

Espejo de aumento con ventosas metal/cristal

Увеличительное зеркало на присосках металл/стекло





CO2019

20 x 11,8 x 32,3 cm

Ingranditore e non - metallo

Magnifying and non-magnifying - metal

Grossissant et non grossissant - métal

Mit und ohne Vergrößerung - Metall

De aumento y normal - metal

Двустороннее увеличительное и не увеличительное зеркало - металл

13

Cromato
Chromed



CO2023 G•MONICA

17,2 x 3,9 x 17,5 cm

Ingranditore e non - metallo

Magnifying and non-magnifying - metal

Grossissant et non grossissant - métal

Mit und ohne Vergrößerung - Metall

De aumento y normal - metal

Двустороннее увеличительное и не увеличительное зеркало - металл

02

Bianco
White

13

Cromato
Chromed

79

Lilla
Lilac

5x

**CO2022 G•ELENA**

16,5 x 1,8 x 19 cm

Ingranditore e non - resine termoplastiche
 Magnifying and non-magnifying mirror in thermoplastic resins
 Grossissant et non grossissant - thermoplastique
 Mit und ohne Vergrößerung - Kunststoff
 De aumento y normal - resinas termoplásticas
 Двустороннее увеличительное и обычное зеркало - термопластичная смола

02

Bianco
White

76

Fucsia
Fuchsia

92

Turchese
Turquoise

2x

**CO2018**

17,6 x 10 x 25 cm

Ingranditore e non - resine termoplastiche
 Magnifying and non-magnifying mirror in thermoplastic resins
 Grossissant et non grossissant - thermoplastique
 Mit und ohne Vergrößerung - Kunststoff
 De aumento y normal - resinas termoplásticas
 Двустороннее увеличительное и обычное зеркало - термопластичная смола

00

Trasparente
Transparent

05

Blu
Blue

79

Lilla
Lilac

Bilancia pesapersona elettronica

Electronic bathroom scale - Pèse-personne électronique - Elektronische Personenwaage
 Báscula pesa-personas electrónica Весы электронные напольные

**RA90 G•RAINBOW**

34 x 27,4 x 2,7 cm

Realizzata in vetro, metallo e resine termoplastiche

In glass, metal and thermoplastic resins
 Réalisé en verre, métal et thermoplastique
 Hergestellt aus Glas, Metall und Kunststoff
 Realizada en cristal, metal y resinas termoplásticas

Изготовлено из стекла, металла и термопластичных смол

04

Verde acido
Acid green

05

Blu
Blue

14

Nero
Black

67

Arancio
Orange

HYGIENE



Cestini in acciaio inox

Waste bins of stainless steel - Poubelles en acier inoxydable - Treteimer aus Edelstahl - Cubos de basura de acero inox - Урны из нержавеющей стали

2809 - Lt. 5

22,8 x 23,2 x 30 cm



13

Lucido
Polished

2309 G•ARGENTA - Lt. 5

20,5 x 24 x 30 cm



13

Lucido
Polished

2209 G•ARGENTA - Lt. 3

16,5 x 21,5 x 25 cm



13

Lucido
Polished

2909 G•ARGENTA - Lt. 5

14 x 29,4 x 30 cm



13

Lucido
Polished

2409 - Lt. 7

20,5 x 26,5 x 31,8 cm



13

Lucido
Polished

2709 G•ARGENTA - Lt. 5

20,5 x 26,5 x 27,8 cm



13

Lucido
Polished

2609 - Lt. 3

17 x 22,5 x 26 cm



13

Lucido
Polished

Cestini in resine termoplastiche

G•RAINBOW

Waste bins in thermoplastic resins - Poubelles en thermoplastique
 Treteimer aus Kunststoff - Cubos de basura de resinas termoplásticas
 Урны из термопластичных смол



RA09 - Lt. 6

18 x 18 x 23,7 cm



02	04	05	06	14	67	73	79
Bianco White	Verde acido Acid green	Blu Blue	Rosso Red	Nero Black	Arancio Orange	Argento Silver	Lilla Lilac

100%
made in Italy



G•BOXER

Design: Makio Hasuike

02

Bianco
White



2009 - Lt. 10,8

ø 22,5 x 31 cm



G•GLADY

00

Trasparente
Transparent

02

Bianco
White

04

Verde acido
Acid green

05

Blu
Blue

GLO9 - Lt. 6,6

ø 21,1 x 25,4 cm



100%
made in Italy

Novità - New

G•SEVENTY

08

Grigio
Grey

22

Bianco
White

66

Beige
Beige



6309 - Lt. 8

20 x 20 x 24,6 cm



100%
made in Italy

Novità - New

G•EYE

02

Bianco
White



1209 - Lt. 6

ø 19 x 26,5 cm





1009 G•PENG- Lt. 7,5

Design: Pedrizzetti e Associati

22,9 x 23,8 x 34,5 cm



100%
made in Italy



Bianco/Nero
White/Black

8009 G•JUNIOR - Lt. 4,8

Design: Olaf Von Bohr

21 x 15 x 34 cm



100%
made in Italy



Bianco
White



Grigio
Grey



Tortora
Turtledove
grey



Beige
Beige

8609 G•VENEZIA - Lt. 6

ø 23 x 24,5 cm



100%
made in Italy



Bianco
White

Scopini wc in metallo

Metal toilet brushes - Porte-brosse en métal - WC-Bürstengarnituren aus Metall
Escobilleros en metal - Туалетный ёршик из металла

NE33/O3 G•NEMESIA

9 x 9,5 x 38 cm



Da muro
Wall brush holder
Mural
Bürstengarnitur
mit Wandhalterung
De pared
Настенный ёршик

13
Lucido
Polished

Acciaio inox
Stainless steel
Acier inoxydable
Edelstahl
Acero inox
Нержавеющая сталь

ED34/O3 G•EDERA

ø 7,5 x 7,8 x 40 cm



Da muro
Wall brush holder
Mural
Bürstengarnitur
mit Wandhalterung
De pared
Настенный ёршик

13
Lucido
Polished

Acciaio inox
Stainless steel
Acier inoxydable
Edelstahl
Acero inox
Нержавеющая сталь

2733/O3 G•ASCOT

ø 8,5 x 9 x 38 cm



Da muro
Wall brush holder
Mural
Bürstengarnitur
mit Wandhalterung
De pared
Настенный ёршик

13
Lucido
Polished

Acciaio inox
Stainless steel
Acier inoxydable
Edelstahl
Acero inox
Нержавеющая сталь

7533 G•ROMANCE

ø 9 x 41 cm



44
Bronzo
Bronze

Acciaio inox/Cromall®
Stainless steel/Cromall®
Acier inoxydable/Cromall®
Edelstahl/Cromall®
Acero inox/Cromall®
Нержавеющая сталь/Cromall®

3833 G•KANSAS

8,7 x 8,7 x 36 cm



13
Lucido
Polished

Acciaio inox
Stainless steel
Acier inoxydable
Edelstahl
Acero inox
Нержавеющая сталь

EE33 G•ELETTRA

ø 8 x 46,8 cm



15
Rame
Copper

Acciaio inox
Stainless steel
Acier inoxydable
Edelstahl
Acero inox
Нержавеющая сталь

2133 G•WINNY

ø 9 x 38 cm



13
Lucido
Polished

Acciaio inox
Stainless steel
Acier inoxydable
Edelstahl
Acero inox
Нержавеющая сталь

NE33 G•NEMESIA

9 x 9 x 38 cm



13
Lucido
Polished

Acciaio inox
Stainless steel
Acier inoxydable
Edelstahl
Acero inox
Нержавеющая сталь

PR33 G•PRIMULA

ø 10 x 38 cm



21
Lucido
spazzolato
Polished/
brushed

Acciaio inox
Stainless steel
Acier inoxydable
Edelstahl
Acero inox
Нержавеющая сталь

ED34 G•EDERA

ø 7,5 x 40 cm

13Lucido
Polished

Acciaio inox
Stainless steel
Acier inoxydable
Edelstahl
Acero inox
Нержавеющая сталь

GE33 G•GENZIANA

ø 7,5 x 33 cm

13Lucido
Polished**02**Bianco
White

Acciaio inox
Stainless steel
Acier inoxydable
Edelstahl
Acero inox
Нержавеющая сталь

FE33 G•FELCE

ø 7,5 x 33 cm

13Lucido
Polished

Acciaio inox
Stainless steel
Acier inoxydable
Edelstahl
Acero inox
Нержавеющая сталь

2733 G•ASCOT

ø 8,5 x 38 cm

13Lucido
Polished

Acciaio inox
Stainless steel
Acier inoxydable
Edelstahl
Acero inox
Нержавеющая сталь

5233 G•FLIP

Design: Piet Billekens

ø 9,1 x 37,7 cm

02Bianco
White**Novità - New****13**Lucido
Polished**14**Nero matt
Matt black

Acciaio
Steel
Acier
Stahl
Acero
Сталь

DS33 G•DIASPRO

ø 10 x 38,5 cm

13Cromato
Chromed

Acciaio inox
Stainless steel
Acier inoxydable
Edelstahl
Acero inox
Нержавеющая сталь

CO34 G•ORIENTE

ø 9,5 x 37 cm

13Lucido
Polished

Acciaio inox
Stainless steel
Acier inoxydable
Edelstahl
Acero inox
Нержавеющая сталь

Scopini wc in vetro e ceramica

Glass and pottery toilet brushes - Porte-brosse en verre céramique - WC-Bürstengarnituren aus Glas und Keramik
Escobilleros en cristal y cerámica- Туалетный ершик из стекла и керамики

5733/O3 G•GLAMOUR

10 x 13 x 39 cm



Da muro
Wall brush holder
À mur
Wandbürstengarnitur
De pared
Настенный ёршик

Cromall®/vetro
Cromall®/glass
Cromall®/verre
Cromall®/Glas
Cromall®/cristal
Cromall®/стекла

13

Cromato
Chromed

PI33/O3 G•PIRENEI

8,5 x 10,9 x 36,5 cm



Da muro
Wall brush holder
À mur
Wandbürstengarnitur
De pared
Настенный ёршик

Ottone/Cromall®/vetro
Brass/Cromall®/glass
Laiton/Cromall®/verre
Messing/Cromall®/Glas
Latón/Cromall®/cristal
Латуни/Cromall®/стекла

13

Cromato
Chromed

14

Nero matt
Matt black

5533 G•KENT

9,7 x 9 x 36,2 cm



Cromall®/vetro
Cromall®/glass
Cromall®/verre
Cromall®/Glas
Cromall®/cristal
Cromall®/стекла

13

Lucido
Polished

5733 G•GLAMOUR

10 x 10 x 39 cm



Cromall®/vetro
Cromall®/glass
Cromall®/verre
Cromall®/Glas
Cromall®/cristal
Cromall®/стекла

02

Bianco
White

PE33 G•PETUNIA

ø 9 x 44,8 cm



Acciaio inox/ceramica/resine termoplastiche
Stainless steel/pottery/thermoplastic resins
Acier inoxydable/céramique/thermoplastique
Edelstahl/Keramik/Kunststoff
Acero inox/cerámica/resinas termoplásticas
Нержавеющая сталь/керамики/
термопластичные смолы

02

Bianco
White

VE33 G•VERBENA

ø 7,8 x 7,8 x 45,6 cm



Acciaio inox/ceramica/resine termoplastiche
Stainless steel/pottery/thermoplastic resins
Acier inoxydable/céramique/thermoplastique
Edelstahl/Keramik/Kunststoff
Acero inox/cerámica/resinas termoplásticas
Нержавеющая сталь/керамики/
термопластичные смолы

02

Bianco
White

Scopini wc in resine termoplastiche

G•CUCCILOLO

Design: Makio Hasuike

Thermoplastic resins toilet brushes - Porte-brosse en thermoplastique - WC-Bürstengarnituren aus Kunststoff
Escobilleros en resinas termoplásticas - Ёршик из термопластичных смол



2033

ø 15 x 33,5 cm

Ciuffo in PVC o setole
PVC or bristle brush
Brosse en PVC ou nylon
Bürste aus Nylon oder PVC
Escobilla de nylon o PVC
Щетка из нейлона или PVC

100%
made in Italy



02
Bianco
White

MoMA June 27, 1977
In permanent Design Collection
of the Museum of Modern Art
in New York

100%
made in Italy



G•OSCAR

Design: Matteo Thun



8533-03

11 x 15 x 35 cm



Fissaggio
con biadesivo
o viti
To be fixed with
double-sided
adhesive tape
or screws



02

Bianco
White

8833

ø 13 x 35 cm



02

Bianco
White

P0

Rosa
Pink

P1

Azzurro
Light blue

P2

Bianco
opalino
Opaline white

P7

Acquamarina
Aquamarine

COLORI LUCIDI - POLISHED COLOURS

NEW

NEW

NEW

22

Bianco
lucido
Polished
White

08

Grigio
Grey

66

Beige
Beige

100%
made in Italy

Novità - New

G•PETER

- 08 Grigio Grey
- 22 Bianco White
- 66 Beige Beige



6033

ø 14 x 41 cm

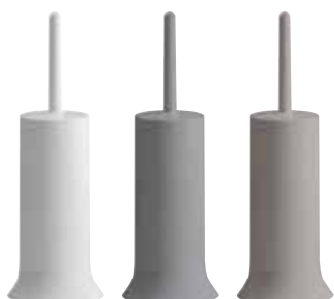

6334 G•SEVENTY

Design: Matteo Thun

9 X 9 X 38,8 cm



100%
made in Italy

3133 G•MOBY

Design: Babled & Co

11,1 x 10,9 x 37,8 cm



100%
made in Italy

8034 G•JUNIOR

Design: Gianpiero Tonetti

ø 12,5 x 37,5 cm



100%
made in Italy

8033 G•JUNIOR

ø 13,5 x 39 cm



100%
made in Italy

ZE33 G•ZENO

ø 12,2 x 37,6 cm



100%
made in Italy

Sedili wc

Toilet seats - Abattants - WC-Sitze - Asientos de inodoro - Туалетное сиденье



4026 G•CORNIOLA

37 x 47 x 7 cm



02

Bianco
White

Realizzato in MDF con laccatura epossidica e cerniere in Cromall®

Made of epoxy lacquered M.D. with Cromall® hinges
Réalisé en M.D. avec laquage époxy et fixations en Cromall®
Hergestellt aus M.D. mit Epoxid-Beschichtung mit Scharnieren aus Cromall®
Realizado en DM pintado epoxi y bisagras de Cromall®
Туалетное сиденье из МДФ, покрытие эпоксидным лаком и петли из Cromall®

4007 G•SMERALDO

37,8 x 47 x 4 cm



02

Bianco
White

Realizzato in MDF con laccatura epossidica e cerniere in ottone cromato

Made of epoxy lacquered M.D. with chromed brass hinges
Réalisé en M.D. avec laquage époxy et fixations en laiton chromé
Hergestellt aus M.D. mit Epoxid-Beschichtung mit Scharnieren aus verchromtem Messing
Realizado en DM pintado epoxi y bisagras de latón cromado
Туалетное сиденье из МДФ покрытие эпоксидным лаком и хромированные латунные петли

4029 G•ACQUAMARINA

35,6 x 48,5 x 3 cm



02

Bianco
White

Realizzato in MDF e cerniere in Cromall®

Made of M.D. with Cromall® hinges
Réalisé en M.D. et fixations en Cromall®
Hergestellt aus M.D. mit Scharnieren aus Cromall®
Realizado en DM y bisagras de Cromall®
Туалетное сиденье из МДФ с петлями из Cromall®

Novità - New

4025 G•AGATA

36,8 x 45,4 x 5,4 cm



02

Bianco
White

Realizzato in MDF con laccatura epossidica e cerniere in polipropilene

Made of epoxy lacquered M.D. with polypropylene hinges
Réalisé en M.D. avec laquage époxy et fixations en polypropylène
Hergestellt aus M.D. mit Epoxid-Beschichtung mit Scharnieren aus Polypropylen
Realizado en DM pintado epoxi con bisagras de polipropileno
Туалетное сиденье из МДФ, покрытие эпоксидным лаком и полипропиленовые петли

Realizzato in MDF con laccatura epossidica e cerniere in ottone cromato

Made of epoxy lacquered M.D with chromed brass hinges

Réalisé en M.D. avec laquage époxy et fixations en laiton chromé

Hergestellt aus M.D. mit Epoxid-Beschichtung mit Scharnieren aus verchromtem Messing

Realizado en DM pintado epoxi con bisagras de latón cromado

Изготовлено из МДФ, покрытие эпоксидным лаком и петли из хромированной латуни

4005

37,8 x 46,5 x 6 cm



Sedile WC per sanitari modello disabili

Toilet seat for disabled model bathroom fittings

Abattant pour sanitaires modèle porteurs de handicap

WC-Sitz für Modell Behinderte

Asiento de inodoro para sanitarios para minusválidos

Сиденье для унитаза модели для инвалидов

4009

36,5 x 45,5 x 6 cm



Sedile WC per sanitari modello disabili

Toilet seat for disabled model bathroom fittings

Abattant pour sanitaires modèle porteurs de handicap

WC-Sitz für Modell Behinderte

Asiento inodoro para sanitarios para minusválidos

Сиденье для унитаза модели для инвалидов

4022

34 x 46 x 5 cm



Sedile WC per sanitari modello Conca

Toilet seat for Conca sanitary fixtures

Abattant pour sanitaires modèle Conca

WC-Sitz für Modell Conca

Asiento de inodoro para sanitarios modelo Conca

Сиденье для унитаза модели Conca

4023

34,8 x 42,5 x 6 cm



Sedile WC per sanitari modello Tesi

Toilet seat for Tesi sanitary fixtures

Abattant pour sanitaires modèle Tesi

WC-Sitz für Modell Tesi

Asiento de inodoro para sanitarios modelo Tesi

Сиденье для унитаза модели Tesi

4014

35 x 46,5 x 5,9 cm



02

Bianco
White

Sedile WC per sanitari modello Ellisse
Toilet seat for Ellisse sanitary fixtures
Abattant pour sanitaires modèle Ellisse
WC-Sitz für Modell Ellisse
Asiento de inodoro para sanitarios modelo Ellisse
Сиденье для унитаза модели Ellisse

4024

36 x 47 x 5,5 cm



02

Bianco
White

Sedile WC per sanitari modello Aretusa
Toilet seat for Aretusa sanitary fixtures
Abattant pour sanitaires modèle Aretusa
WC-Sitz für Modell Aretusa
Asiento de inodoro para sanitarios modelo Aretusa
Сиденье для унитаза модели Aretusa

4027

35 x 48 x 5,8 cm



02

Bianco
White

Sedile WC per sanitari modello Sintesi
Toilet seat for Sintesi sanitary fixtures
Abattant pour sanitaires modèle Sintesi
WC-Sitz für Modell Sintesi
Asiento de inodoro para sanitarios modelo Sintesi
Сиденье для унитаза модели Sintesi

4028

36 x 41,5 x 6 cm



02

Bianco
White

Sedile WC per sanitari modello Victoria
Toilet seat for Victoria sanitary fixtures
Abattant pour sanitaires modèle Victoria
WC-Sitz für Modell Victoria
Asiento de inodoro para sanitarios modelo Victoria
Сиденье для унитаза модели Victoria

4030

34,4 x 44,7 x 6 cm



02

Bianco
White

Sedile WC per sanitari modello System
Toilet seat for System sanitary fixtures
Abattant pour sanitaires modèle System
WC-Sitz für Modell System
Asiento de inodoro para sanitarios modelo System
Сиденье для унитаза модели System

CO41 G•GRANATO

37,5 x 45,6 x 5,5 cm



Realizzato in MDF con laccatura epossidica e cerniere in ottone cromato

Made of epoxy lacquered M.D. with chromed brass hinges

Réalisé en M.D. avec laquage époxy et fixations en laiton chromé

Hergestellt aus M.D. mit Epoxid-Beschichtung mit Scharnieren aus verchromtem Messing

Realizado en DM pintado epoxi y bisagras de latón cromado

Туалетное сиденье из МДФ покрытие эпоксидным лаком и хромированные латунные петли

Stampa
3D
Print



02
Tigre



04
Rana



05
Tartaruga



06
Pesce
pagliaccio



63
Fiori



86
Pinguino



92
Caraibi

CO42 G•ONICE

37,5 x 44,5 x 6 cm



Realizzato in MDF con laccatura epossidica e decoro metallico, dotato di cerniere in ottone cromato

Made of epoxy lacquered M.D. with decorative metal plate, chromed brass hinges

Réalisé en M.D. avec laquage époxy et plaque de métal, fixations en laiton chromé

Hergestellt aus M.D. mit Epoxid-Beschichtung mit Metall-Dekor, mit Scharnieren aus verchromtem Messing

Realizado en DM pintado epoxi con placa metálica, bisagras de latón cromado

Изготовлено из МДФ с металлической пластиной, покрытие эпоксидным лаком и петли из хромированной латуни

Decoro
METALLICO
Decorative
**METAL
PLATE**



02
Open



06
Gas

4001 G · AMETISTA

37,8 x 45,7 x 5 cm



02

Bianco
White



Realizzato in resine termoindurenti con cerniere in acciaio inox

Made of thermosetting resins, hinges of stainless steel

Réalisé en thermodurcissable, fixations en acier inoxydable

Hergestellt aus Duroplast, Scharniere aus Edelstahl

Realizado en resinas termoestables con bisagras de acero inoxidable

Изготовлено из термореактивных пластмасс с петлями из нержавеющей стали

4031 G · MADREPERLA

36,3 x 45,6 x 3 cm



02

Bianco
White

Realizzato in polipropilene con cerniere in polipropilene
 Made of polypropylene with polypropylene hinges
 Réalisé en polypropylène avec fixations en polypropylène
 Hergestellt aus Polypropylen mit Scharnieren aus Polypropylen
 Realizado en polipropileno con bisagras de polipropileno
 Изготовлено из полипропилена, Полипропиленовые петли

Novità - New

4003 G · ZIRCONO

37,2 x 45,8 x 5,4 cm

02

02

Bianco
White



Realizzato in resine termoindurenti con cerniere in acciaio inox

Made of thermosetting resins, hinges of stainless steel

Réalisé en thermodurcissable, fixations en acier inoxydable

Hergestellt aus Duroplast, Scharniere aus Edelstahl

Realizado en resinas termoestables con bisagras de acero inoxidable

Изготовлено из термореактивных пластмасс с петлями из нержавеющей стали

4017 G•DIAMANTE

37,3 x 45,7 x 5,7 cm

**02**Bianco
White

Realizzato in resine termoindurenti, dotato di cerniere in resine termoplastiche

Made of thermosetting resins with adjustable plastic hinges

Réalisé en thermodurcissable avec fixations réglables en thermoplastique

Hergestellt aus Duroplast mit Scharnieren aus Kunststoff

Realizado en resinas termoestables con bisagras de resinas termoestables

Изготовлено из термореактивных пластмасс.

Петли из термопластичных смол

4019 G•OSCAR

37 x 45,5 x 4 cm

**02**Bianco
White

100%
made in Italy



Realizzato in resine termoplastiche con cerniere in polipropilene

Made of thermoplastic resin with polypropylene hinges

Réalisé en thermoplastique avec fixations en polypropylène

Hergestellt aus Kunststoff mit Scharnieren aus Polypropylen

Realizado en resinas termoplásticas con bisagras de polipropileno

Изготовлено из термопластичных смол. Полипропиленовые петли

4008 G•AMBRA

37,5 x 46,5 x 3 cm

**02**Bianco
White

100%
made in Italy



Realizzato in resine termoplastiche con cerniere in polipropilene

Made of thermoplastic resin with polypropylene hinges

Réalisé en thermoplastique avec fixations en polypropylène

Hergestellt aus Kunststoff mit Scharnieren aus Polypropylen

Realizado en resinas termoplásticas con bisagras de polipropileno

Изготовлено из термопластичных смол. Полипропиленовые петли

MULTIFUNCTION



Piantane

G•TOBIA

Towel stands
Ensembles sur pied
Handtuchständer
Columns
Стойка для полотенец

13

Cromato
Chromed



7131

40,6 x 15,5 x 89 cm

7132

33 x 15,5 x 64 cm

Realizzate in acciaio inox e resine termoplastiche
Made of stainless steel and thermoplastic resins
Réalisés en acier inoxydable et thermoplastique
Hergestellt aus Edelstahl und Kunststoff
Realizadas en acero inox y resinas termoplásticas
Изготовлено из нержавеющей стали и термопластичных смол





7831

39 x 16 x 89 cm

7832

25 x 16 x 70 cm

Realizzate in acciaio inox, Cromall® e resine termoplastiche

Made of stainless steel, Cromall® and thermoplastic resins

Réalisés en acier inoxydable, Cromall® et thermoplastique

Hergestellt aus Edelstahl, Cromall® und Kunststoff

Realizadas en acero inox, Cromall® y resinas termoplásticas

Изготовлено из нержавеющей стали, Cromall® и термопластичных смол





2131

ø 21 x 42 x 88 cm

2132

ø 21 x 26 x 61 cm

Realizzate in acciaio inox e resine termoplastiche

Made of stainless steel and thermoplastic resins

Réalisés en acier inoxydable et thermoplastique

Hergestellt aus Edelstahl und Kunststoff

Realizadas en acero inox y resinas termoplásticas

Изготовлено из нержавеющей стали и термопластичных смол



G•RAINBOW

COLORI TRASPARENTI - TRASPARENT COLOURS

02	04	05	06	14	52	66	67	73	79
Bianco White	Verde acido Acid green	Blu Blue	Rosso Red	Nero Black	Tortora Turtledove grey	Tortora chiaro Light turtledove grey	Arancio Orange	Argento Silver	Lilla Lilac

COLORI PIENI - SOLID COLOURS

08	22	01	12
Grigio Grey	Bianco White	Tortora Turtledove grey	Tortora chiaro Light turtledove grey



RA31

40,4 x 15,5 x 83,7 cm

RA32

25,7 x 16 x 58,8 cm

Realizzate in acciaio inox e resine termoplastiche

Made of stainless steel and thermoplastic resins

Réalisés en acier inoxydable et thermoplastique

Hergestellt aus Edelstahl und Kunststoff

Realizadas en acero inox y resinas termoplásticas

Изготовлено из нержавеющей стали и термопластичных смол





2731

ø 25 x 43,5 x 93,7 cm

2732

ø 25 x 25,5 x 78,5 cm

Realizzate in metallo con contenitori in vetro satinato

Made of metal with frosted glass containers

Réalisés en métal avec boîtiers en verre satiné

Hergestellt aus Metall mit Behältern aus satiniertem Glas

Realizadas en metal con contenedores en cristal satinado

Изготовлено из металла с ёмкостями из матового стекла



G•WINNY

Design: Piet Billekens

02

Bianco
White

13

Cromato
Chromed



2831

ø 25 x 43,6 x 89 cm

2832

ø 25 x 29 x 67 cm

Realizzate in acciaio inox

Made of stainless steel

Réalisés en acier inoxydable

Hergestellt aus Edelstahl

Realizadas en acero inox

Изготовлено из нержавеющей сталь



13

Cromato
Chromed

03

Beige
Beige

TR31

34 x 14 x 83,3 cm

TR32

14 x 14 x 62,8 cm

03 Realizzate in acciaio inox, Cromall®, resina, sabbia e resina termoplastica
 Made of stainless steel, Cromall®, resin, sand and thermoplastic resins
 Réalisés en acier inoxydable, Cromall®, résine, sable et thermoplastique
 Hergestellt aus Edelstahl, Cromall®, Harz, Sand und Kunststoff
 Realizadas en acero inox, Cromall®, resina, arena y resinas termoplásticas
 Изготовлено из нержавеющей стали, Cromall®, смол, песчаника и термопластичных смол

13 Realizzate in acciaio inox, Cromall® e resina termoplastica

Made of stainless steel, Cromall® and thermoplastic resins
 Réalisés en acier inoxydable, Cromall® et thermoplastique
 Hergestellt aus Edelstahl, Cromall® und Kunststoff
 Realizadas en acero inox, Cromall® y resinas termoplásticas
 Изготовлено из нержавеющей стали, Cromall® и термопластичных смол



G•HIBISCUS

13

Cromato
Chromed

HI31

36,5 x 30 x 90,5 cm

HI32

29,6 x 18 x 75 cm

Realizzate in metallo
 Made of metal
 Réalisés en métal
 Hergestellt aus Metall
 Realizadas en metal
 Изготовлено из металла



100%
made in Italy



G•MAMMOLO

02

Bianco
White



MM31

24,5 x 43 x 89,5 cm

MM32

20 x 20 x 78,5 cm

Realizzate in alluminio, acciaio inox e resine termoplastiche

Made of aluminum, stainless steel and thermoplastic resins

Réalisés en aluminium, acier inoxydable et thermoplastique

Hergestellt aus Aluminium, Edelstahl und Kunststoff

Realizadas en aluminio, acero inox y resinas termoplásticas

Изготовлено из алюминий, нержавеющей стали и термопластичных смол



Novità - New

G•MINU'

Piantana portarotolo di riserva

Freestanding spare toilet paper holder
 Support de papier WC sur pied
 Ständer Ersatzrollenhalterung
 Soporte portarrollos de reserva
 Держатель запасного рулона

13

Cromato
 Chromed

**MU37**

14,2 x 23 x 61 cm

Realizzate in metallo
 Made of metal
 Réalisés en métal
 Hergestellt aus Metall
 Realizado en metal
 Изготовлено из металла



G•WENDY

Design: Babled e Co.

02	48	58	71	39
Bianco White	Bianco/ tortora White/ turtledove grey	Bianco/ tortora chiaro White/light turtledove grey	Bianco/ grigio White/ grey	Bianco/ blu White/ blue



7032

20,4 x 16 x 69,8 cm

Realizzata in resine termoplastiche
 Made of thermoplastic resins
 Réalisée en thermoplastique
 Hergestellt aus Kunststoff
 Realizado en resinas termoplásticas
 Изготовлено из термопластичных смол



**1031**

50 x 4 x 190 cm

Realizzata in bambù
Made of bamboo
Réalisée en bambou
Hergestellt aus Bambus
Realizada en bambú
Изготовлено из бамбука



Appendiabiti

Hooks - Crochets - Haken - Perchas - Крючки

2128

20 x 3,1 x 4 cm



Cromall®/ottone
Cromall®/brass
Cromall®/laiton
Cromall®/Messing
Cromall®/latón
Cromall®/латунь

13
Cromato
Chromed

2123

40 x 7,2 x 12,2 cm

Sopraporta
Over door



Acciaio inox
Stainless steel
Acier inoxydable
Edelstahl
Acero inox
нержавеющей стали

13
Lucido
Polished

2124

40 x 5,4 x 13,6 cm

Sopraporta
Over door

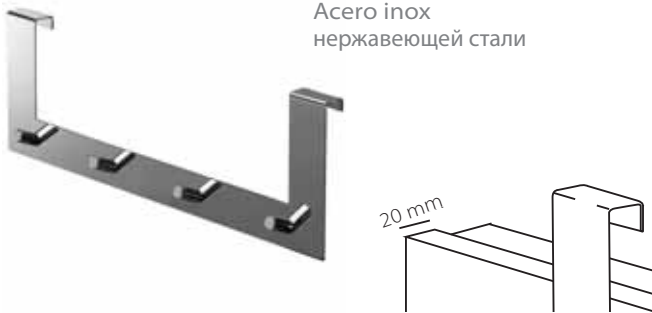

Acciaio inox
Stainless steel
Acier inoxydable
Edelstahl
Acero inox
нержавеющей стали

13
Lucido
Polished

4226 G•VERMONT

7,5 x 5 x 6 cm

Cromall®



Fissabile anche con colla (venduta a parte)
Can be fixed with glue (sold separately)
Peut être fixé avec colle (vendu séparément)
Kann mit Kleber fixiert werden (separat erhältlich)
Se puede fijar con pegamento (se vende por separado)
Может быть закреплён клеем (продается отдельно)

13
Cromato
Chromed

2127

ø 1,8 x 3 cm

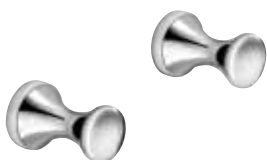

Ottone
Brass
Laiton
Messing
Latón
латунь

13
Cromato
Chromed

6928 G•COLORADO

6,5 x 6 x 4 cm

Cromall®



Fissabile anche con colla (venduta a parte)
Can be fixed with glue (sold separately)
Peut être fixé avec colle (vendu séparément)
Kann mit Kleber fixiert werden (separat erhältlich)
Se puede fijar con pegamento (se vende por separado)
Может быть закреплён клеем (продается отдельно)

13
Cromato
Chromed

6926 G•COLORADO

4 x 5 x 4 cm

Cromall®



Fissabile anche con colla (venduta a parte)
Can be fixed with glue (sold separately)
Peut être fixé avec colle (vendu séparément)
Kann mit Kleber fixiert werden (separat erhältlich)
Se puede fijar con pegamento (se vende por separado)
Может быть закреплён клеем (продается отдельно)

13
Cromato
Chromed

Appendiabiti doppio

G•RAINBOW

Double hook
Crochet double
Haken doppelt
Percha doble
Двойная вешалка



RA26

8 x 3,1 x 4 cm

Realizzati in resine termoplastiche

Made of thermoplastic resins

Réalisés en thermoplastique

Hergestellt aus Kunststoff

Realizadas en resinas termoplásticas

Изготовлено из термопластичных смол



Fissaggio con biadesivo

To be fixed with double - sided adhesive

Fixation avec adhésif double face

Befestigung mit doppelseitigem Klebeband

Fijación con adhesivo de dos caras

Крепление при помощи двухсторонней

клеякой ленты



COLORI PIENI - SOLID COLOURS

- 01** Tortora
Turtledove
grey
- 08** Grigio
Grey
- 12** Tortora
chiaro
Light
turtledove
grey
- 22** Bianco
White

COLORI TRASPARENTI - TRASPARENT COLOURS

- 02** Bianco
White
- 04** Verde acido
Acid green
- 05** Blu
Blue
- 06** Rosso
Red
- 14** Nero
Black
- 52** Tortora
Turtledove
grey
- 66** Tortora
chiaro
Turtledove
grey
- 67** Arancio
Orange
- 73** Argento
Silver
- 79** Lilla
Lilac

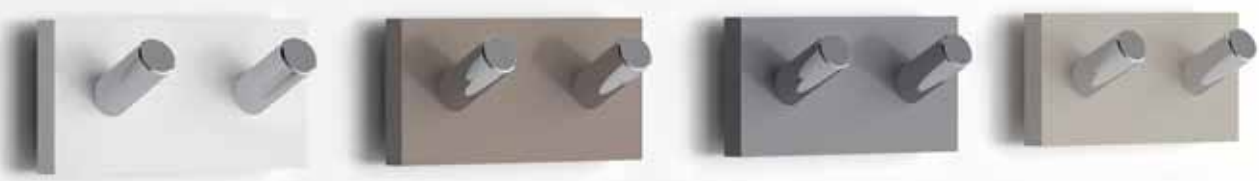

Appendiabiti singolo

G•RAINBOW

Hook
Crochet
Haken
Percha
Одинарный крючок



RA27

4,3 x 3,4 x 6,5 cm

Realizzati in resine termoplastiche

Made of thermoplastic resins

Réalisés en thermoplastique

Hergestellt aus Kunststoff

Realizadas en resinas termoplásticas

Изготовлено из термопластичных смол



Fissaggio con biadesivo

To be fixed with double - sided adhesive

Fixation avec adhésif double face

Befestigung mit doppelseitigem Klebeband

Fijación con adhesivo de dos caras

Крепление при помощи двухсторонней

клеякой ленты



COLORI PIENI - SOLID COLOURS

- 01** Tortora
Turtledove grey
- 08** Grigio
Grey
- 12** Tortora
chiaro
Light
turtledove
grey
- 22** Bianco
White

COLORI TRASPARENTI - TRASPARENT COLOURS

- 02** Bianco
White
- 04** Verde acido
Acid green
- 05** Blu
Blue
- 06** Rosso
Red
- 14** Nero
Black
- 52** Tortora
Turtledove
grey
- 66** Tortora
chiaro
Light
turtledove
grey
- 67** Arancio
Orange
- 73** Argento
Silver
- 79** Lilla
Lilac



Appendiabiti per termoarredi

G•MERLINO

Hanging hook for designer radiators
Crochets décoratifs pour radiateurs
Kleiderhaken für Heizkörper
Percha para toalleros radiadores decorativos
Вешалка на батарею



2025

3,2 x 6,7 x 11,7 cm

Realizzati in resine termoplastiche

Made of thermoplastic resins

Réalisés en thermoplastique

Hergestellt aus Kunststoff

Realizadas en resinas termoplásticas

Изготовлено из термопластичных смол

COLORI TRASPARENTI - TRANSPARENT COLOURS

00	13	29	85	P0	P1	P4	P8	P9
Trasparente Transparent	Cromato Chromed	Moka Moka	Antracite Anthracitey	Fucsia Fuchsia	Azzurro Light blue	Arancio Orange	Verde Green	Lilla Lilac

COLORI PIENI - SOLID COLOURS

02	08	14	52	66
Bianco White	Grigio Grey	Nero Black	Tortora Turtledove grey	Tortora chiaro Light turtledove grey



Porta asciugacapelli

Hairdryer supports
 Supports sèche-cheveux
 Haartrocknerhalter
 Soportes para secador de pelo
 Держатель для фена

13

Cromato
 Chromed



5055

10,6 x 16 x 17 cm

Acciaio inox e Cromall®
 Stainless steel and Cromall®
 Acier inoxydable et Cromall®
 Edelstahl und Cromall®
 Acero inox y Cromall®
 Нержавеющей стали и Cromall®



Fissaggio ad INCOLLO
 Fixes into place with adhesive
 Fixation par encollage
 Befestigung mit Klebstoff
 Fijación mediante pegado
 Крепление клеем



Fissaggio con VITI
 Fixes into place with screws
 Fixation par vis
 Befestigung mit Schrauben
 Fijación con tornillos
 Крепление шурупами

5056

10,6 x 16,3 x 18,2 cm



Acciaio inox e Cromall®
 Stainless steel and Cromall®
 Acier inoxydable et Cromall®
 Edelstahl und Cromall®
 Acero inox y Cromall®
 Нержавеющей стали и Cromall®

13

Cromato
lucido
Chromed

Fissaggio ad INCOLLO
 Fixes into place with adhesive
 Fixation par encollage
 Befestigung mit Klebstoff
 Fijación mediante pegado
 Крепление клеем



Fissaggio con VITI
 Fixes into place with screws
 Fixation par vis
 Befestigung mit Schrauben
 Fijación con tornillos
 Крепление шурупами

HO52 G•HOT

10,7 x 12 x 22 cm



Metallo e resine termoplastiche
 Metal and thermoplastic resins
 Métal et thermoplastique
 Metall und Kunststoff
 Metal y resinas termoplásticas
 металл и термопластичные смолы

13

Cromato
lucido
Chromed

Fissaggio con ventosa - Suction cup fixing
 Fixation avec ventouses
 Befestigung mit Saugnäpfen
 Fijación con ventosas
 Крепление при помощи присосок



5052/301

9,5 x 10,2 x 11,2 cm



Resine termoplastiche
 Thermoplastic resins
 Thermoplastique
 Kunststoff
 Resinas termoplásticas
 термопластичные смолы

100%
 made in Italy



02

Bianco
White

Fissaggio ad INCOLLO
 Fixes into place with adhesive
 Fixation par encollage
 Befestigung mit Klebstoff
 Fijación mediante pegado
 Крепление клеем



TE55

10 x 14 x 7,3 cm

Acciaio inox e Cromall®
 Stainless steel and Cromall®
 Acier inoxydable et Cromall®
 Edelstahl und Cromall®
 Acero inox y Cromall®
 Нержавеющей стали и Cromall®



Fissaggio con biadesivo
 To be fixed with double
 sided sticky tape
 Fixation avec adhésif double face
 Befestigung mit doppelseitigem Klebeband
 Fijación con adhesivo de dos caras
 Крепление при помощи двухсторонней
 клейкой ленты

Sgabelli

Stools
Tabourets
Hocker
Taburetes
Табу­ре­ты



6072

40,9 x 33,1 x 43,8 cm

Design: Studio Talocci

Alluminio/ABS
Aluminium/ABS
Aluminium/ABS
Aluminio/ABS
Алюминий/АБС-пластик



100%
made in Italy



Bianco/
White



Bianco/
cromato
White/
chromed



Antracite/
cromato
Anthracite/
chromed



2872 G•TETRA

Design: Olaf Von Bohr

42 x 27 x 41 cm



Resine termoplastiche
 Thermoplastic resins
 Thermoplastique
 Kunststoff
 Resinas termoplásticas
 термопластичные смолы

100%
 made in Italy

02Bianco
White**2072 G•TRIO**

ø 33 x 40 cm



Resine termoplastiche
 Thermoplastic resins
 Thermoplastique
 Kunststoff
 Resinas termoplásticas
 термопластичные смолы

100%
 made in Italy

02Bianco
White

Sgabello e cesto svuota lavatrice

Stool and laundry basket
 Tabouret et coffre à linge
 Hocker und Wäschebehälter
 Taburete y cesto para ropa
 Табурет и корзина для белья



7073 G•WENDY

35,6 x 32,6 x 38,9 cm



Design: Babled & Co.

Realizzato in resine termoplastiche

Thermoplastic resins

Réalisé en thermoplastique

Hergestellt aus Kunststoff

Realizado en resinas termoplásticas

Изготовлено из термопластичных смол

BELLO RESISTENTE FLESSIBILE
 AGILE COLORATO IMPILABILE
 EYE-CATCHING DURABLE FLEXIBLE
 NIMBLE COLORFUL STACKABLE

Il primo SGABELLO-CESTO che puoi usare come ti GIRA!
 The first STOOL-BASKET to turn your world upside down!



Sgabelli richiudibili

Foldable stools
Tabourets repliables
Klapphocker
Taburetes plegable
Складные табуреты

C073

ø 29,8 x 46 cm



Realizzato in MDF e metallo
MDF and steel
Réalisé en MDF et métal
Hergestellt aus MDF und Metall
Realizado en DM y metal
Изготовлено из MDF и металла



98

Pero
Pear wood

C075

30 x 29,3 x 46,5 cm



Realizzato in resine termoplastiche e metallo
Thermoplastic resins and steel
Réalisé en thermoplastique et métal
Hergestellt aus Kunststoff und Metall
Realizado en resinas termoplásticas y metal
Изготовлено из термопластичных смол
и металла



02

Bianco
White

05

Blu
Blue

67

Arancio
Arancio

76

Fucsia
Fuchsia

79

Lilla
Lilac

02	08	52	66
Bianco White	Grigio Grey	Tortora Turtledove grey	Tortora chiaro Light turtledove grey



CO76

26 x 28 x 46,5 cm

Realizzato in resine termoplastiche e metallo

Made of thermoplastic resins and steel

Réalisé en thermoplastique et métal

Hergestellt aus Kunststoff und Metall

Realizado en resinas termoplásticas y metal

Изготовлено из термопластичных смол и металла

100
kg



Cesti portabiancheria e scatole

G•AMBROGIO

02

 Bianco
White

03

Beige

05

 Blu
Blue

Laundry baskets and boxes - Panier à linge et boîtes - Wäschebehälter und Boxen
Cestos contenedoras para ropa sucia y cajas - Корзина для грязного белья и коробки

2038

50 x 28 x 55 cm

Realizzato in resine termoplastiche
Made of thermoplastic resins
Réalisé en thermoplastique
Hergestellt aus Kunststoff
Realizado en resinas termoplásticas
Изготовлено из термопластичных смол



Novità - New

G•TATAMI

02

Bianco
White

14

Nero
Black

TA38

35,5 x 35,5 x 63 cm

Realizzato in bambù
 Made of bamboo
 Réalisé en bambou
 Hergestellt aus Bambus
 Realizado en bambú
 Изготовлено из бамбука

Sacchetto interno estraibile e lavabile per la massima igiene
 Fully removable and washable sack inside for maximum hygiene
 Sachet intérieur extractible et lavable pour le maximum d'hygiène
 Wäschebeutel, Innenteil abnehmbar und waschbar für maximale Hygiene
 Bolsita interna extraíble y lavable para la máxima higiene
 В целях гигиены внутренний пакет можно извлечь и помыть





BY38

34 x 15 x 60 cm

Realizzato in tessuto (cotone 70%, poliestere 30%)
 Made of fabric (cotton 70%, polyester 30%)
 Réalisé en tissu (coton 70%, polyester 30%)
 Hergestellt aus Stoff (Baumwolle 70%, Polyester 30%)
 Realizado en tela (algodón 70%, poliéster 30%)
 Изготовлено из ткани (хлопок 70%, полиэстер 30%)



03

Ecrù
Ecrù

CO38 G•LAUNDRY

ø 38 x 58 cm



Realizzato in tessuto (cotone 35%, poliestere 65%) e metallo
 Fabric (cotton 35%, polyester 65%) and metal
 Réalisé en tissu (coton 35%, polyester 65%) et métal
 Hergestellt aus Stoff (Baumwolle 35%, Polyester 65%) und Metall
 Realizado en tela (algodón 35%, poliéster 65%) y metal
 Изготовлено из ткани (хлопок 35%, полиэстер 65%) и металла

03

Ecrú

11

Azzurro
Light blue

G•LAVANDA



LA38

35 x 35 x 58 cm

Realizzati in rafia e nylon

Made of raffia and nylon - Réalisés en raphia et nylon - Hergestellt aus Bast und Nylon Realizados en rafia y nylon - Изготовлено из рафии и нейлона

08

Grigio
Grey

29

Moka



LA99 set 4 pz./pcs

2 da cm. 11x10x7,5

1 da cm. 13,5x24x8

1 da cm. 15,5x25,5x9



LA06

31 x 19 x 16,5 cm



LA07

21 x 15 x 12 cm

RA00 G•RAINBOW

19 x 11 x 7,5 cm

**Realizzato in resine termoplastiche**

Made of thermoplastic resins
 Réalisé en thermoplastique
 Hergestellt aus Kunststoff
 Realizado en resinas termoplásticas
 Изготовлено из термопластичных смол

02

Bianco
trasparente
Transparent
white

04

Verde acido
trasparente
Transparent
acid green

05

Blu
trasparente
Transparent
blue

06

Rosso
trasparente
Transparent
red

14

Nero
trasparente
Transparent
black

67

Arancio
trasparente
Transparent
orange

73

Argento
trasparente
Transparent
silver

79

Lilla
trasparente
Transparent
lilac

52

Tortora
trasparente
Transparent
turtledove
grey

66

Tortora chiaro
trasparente
Transparent
light
turtledove
grey

GLOO G•GLADY

18,5 x 10,5 x 7,5 cm

**Realizzato in resine termoplastiche**

Made of thermoplastic resins
 Réalisé en thermoplastique
 Hergestellt aus Kunststoff
 Realizado en resinas termoplásticas
 Изготовлено из термопластичных смол

00

Trasparente
Transparent

Mensole

Shelves - Étagères - Ablagen - Estantes - Полочки

Realizzate in vetro Ultralight 6 mm e Cromall®

Made of 6 mm Ultralight glass and Cromall®

Réalisés en verre Ultralight 6 mm et Cromall®

Hergestellt aus 6 mm Ultralight Glas und Cromall®

Realizados en cristal Ultralight 6 mm y Cromall®

Изготовлено из стекла Ultralight 6 mm и Cromall®

100% **G•ARTEMIS**
made in Italy

2119/24

24 x 24 x 2 cm



2119/30

30 x 16,5 x 2 cm

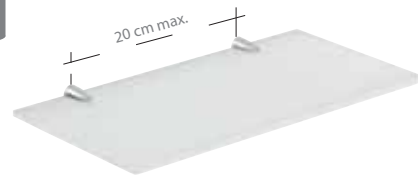

2119/45

45 x 16,5 x 2 cm



2119/60

60 x 16,5 x 2 cm

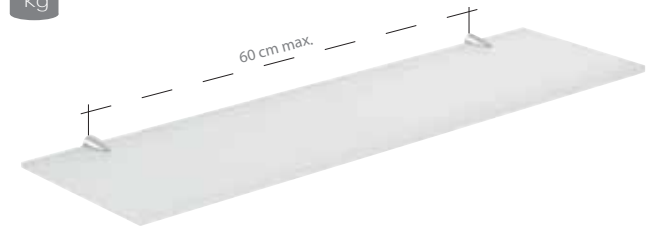

100%
made in Italy

G•SPOT



Fucsia
Fuxia



Azzurro
Light blue



Trasparente
Transparent



Arancio
Orange



Verde acido
Acid green



Lilla
Lilac

NEW NEW NEW



Bianco
White



Grigio
Grey



Tortora
chiaro
Light
turtledove
grey

2004

12,7 x 8,7 x 1,6 cm



Portasapone

Soap holder - Porte savon

Seifenschale - Jabonera - мьльница

Realizzato in PVC

Made of PVC - Réalisé en PVC - Hergestellt aus PVC

Realizada en PVC - Изготовлено из ПВХ

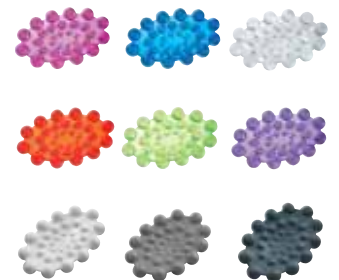

WATER



Angolari e porta oggetti

G•CLOUD

38

Spazzolato
Brushed

Corner shelves - Étagère d'angle
Eckablagen - Estantes angulares
Угловая мыльница в душ

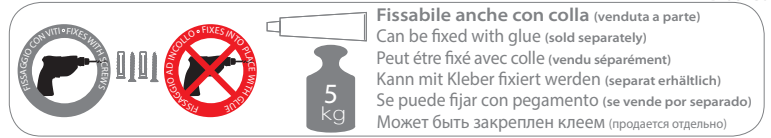
CD18

30 x 14,6 x 5,8 cm

CD82

30 x 14,6 x 30 cm

Alluminio anodizzato, vetro temperato

Anodised aluminium, tempered glass

Aluminium anodisé, verre tempéré

Eloxiertes Aluminium, Sekuritglas

Aluminio anodizado, cristal templado

Анодированный алюминий, закаленного стекла





Fissabile anche con colla (venduta a parte)
 Can be fixed with glue (sold separately)
 Peut être fixé avec colle (vendu séparément)
 Kann mit Kleber fixiert werden (separat erhältlich)
 Se puede fijar con pegamento (se vende por separado)
 Может быть закреплён клеем (продается отдельно)



CD80

26 x 26 x 5,8 cm



CD81

26 x 26 x 30 cm



Realizzati in acciaio inox

Made of stainless steel- Réalisés en acier inoxydable

Hergestellt aus Edelstahl - Realizados en acero inox

Изготовлено из нержавеющей стали

2484

17,2 x 17,2 x 61,5 cm



13

Cromato
Chromed

2482

20 x 15,1 x 32,5 cm



13

Cromato
Chromed

2418

Design: Carlo Vietri

25 x 9,6 x 3,5 cm

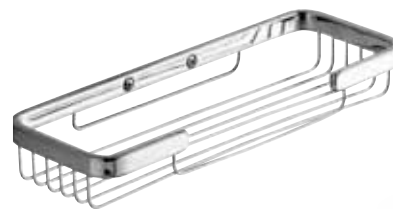

13

Cromato
Chromed

2481

20 x 15 x 27 cm



13

Cromato
Chromed

2480

Design: Carlo Vietri

19,3 x 19,3 x 3,5 cm



13

Cromato
Chromed

2411

Design: Carlo Vietri

12,5 x 10 x 3,5 cm



2405

6 x 1,7 x 3,8 cm

**Kit 2 placche ad incollo**

Pack of 2 plates with glue system - Kit 2 plaques à coller
 Packung mit 2 Wandplatten mit Klebefestigung
 Caja de 2 placas de pared con fijación con pegamento
 Набор из 2 клеящихся пластин в комплекте с клеем

Cromall®**UTILIZZABILI CON I SEGUENTI ANGOLARI**

Can be mounted with - Peut être monté avec - Montierbar mit
 Pueden montarse con - Может устанавливаться с:
 2418 - 2419 - 2480 - 2481 - 2482 - 2483 - 2484

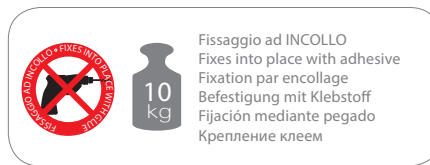
**Realizzati in metallo e resine termoplastiche**

Made of metal and thermoplastic resins - Réalisés en métal et thermoplastique
 Hergestellt aus Metall und Kunststoff - Realizados en metal y resinas termoplásticas
 Изготовлено из металла и термопластичных смол

HO20 G•HOT

27,5 x 13,6 x 12 cm



HO80 G•HOT

19 x 19 x 10 cm



SOLO SU SUPERFICI LISCE (SPECCHI, PIASTRELLE)
 FOR FLAT SURFACES (MIRRORS, TILES) ONLY

Fissaggio con ventosa - Suction cup fixing
 Fixation avec ventouses - Befestigung mit Saugnäpfen
 Fijación con ventosas
 Крепление при помощи присосок



2485

24 x 22 x 49 cm



2486

24 x 22 x 68 cm



Realizzato in metallo
 Made of chromed steel
 Réalisé en métal chromé
 Hergestellt aus verchromtem Metall
 Realizado en metal cromado
 Изготовлено из хромированного металла

G•TITO

13

Cromato
Chromed**2487**

24 x 22 x 49 cm

**2488**

24 x 22 x 68 cm



13

Cromato
Chromed

14

Nero matt
Matt black

2419

25,2x10,2x8,6 cm

2483

20x15,1x8 cm

Realizzati in acciaio inox
 Made of stainless steel
 Réalisée en acier inoxydable
 Hergestellt aus Edelstahl
 Realizada en acero inox
 Изготовлено из нержавеющей сталь

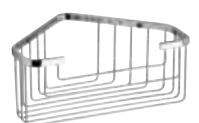

G•NERVA

13

Lucido
Polished

2417

30x12,8x4,5 cm

2479

21x21x4,5 cm

Realizzati in acciaio inox AISI 304

Made of stainless steel AISI 304

Réalisée en acier inoxydable AISI 304

Hergestellt aus Edelstahl AISI 304

Realizada en acero inox AISI 304

Изготовлено из нержавеющей сталь AISI 304



G•TIBERIO

Design: Leo De Carlo

13

Cromato
Chromed

Fissabile anche con colla (venduta a parte)
Can be fixed with glue (sold separately)
Peut être fixé avec colle (vendu séparément)
Kann mit Kleber fixiert werden (separat erhältlich)
Se puede fijar con pegamento (se vende por separado)
Может быть закреплён клеем (продается отдельно)

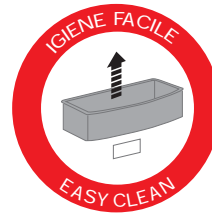

2416

24 x 12,5 x 6,5 cm



2478

19 x 19 x 6,5 cm



Realizzati in resine termoplastiche
Made of thermoplastic resins
Réalisée en thermoplastique
Hergestellt aus Kunststoff
Realizada en resinas termoplásticas
Изготовлено из термопластиченых смол

100%
made in Italy



G•CAESAR

02

Bianco
White

NEW
52

Tortora
Turtledove
grey

NEW
08

Grigio
Grey



7080

22,6 x 16 x 47,3 cm

7081

22,6 x 16 x 71 cm

Realizzate in resine termoplastiche e acciaio inox

Made of thermoplastic resins and stainless steel

Réalisés en thermoplastique et acier inoxydable

Hergestellt aus Kunststoff und Edelstahl

Realizadas en resinas termoplásticas y acero inox

Изготовлено из термопластичных смол и нержавеющей стали



Realizzati in resine termoplastiche

Made of thermoplastic resins

Réalisée en thermoplastique

Hergestellt aus Kunststoff

Realizada en resinas termoplásticas

Изготовлено из термопластиченых смол

8081 G•JUNIOR

22 x 12 x 47 cm

**02**Bianco
White100%
made in Italy**8079 G•JUNIOR**

22 x 14 x 38 cm

**02**Bianco
White100%
made in Italy**8080 G•JUNIOR**

Design: Gianpietro Tonetti

19,6 x 15,6 x 3 cm

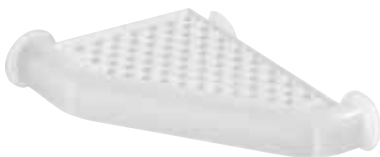
**02**Bianco
White100%
made in Italy

Fissaggio con VITI o VENTOSE
To be fixed with suction cups or screws
Fixation avec ventouses ou vis
Befestigung mit
Saugnapf oder Schrauben
Fijación con ventosas o tornillos
Крепление при помощи присосок или шурупов

G•OSCAR



Fissabile anche con silicone e biadesivo (non incluso)

Can be fixed with silicon and sided sticky tape (not included)

Peut être fixé avec du silicone et de l'adhésif double face (vendu séparément)

Kann mit Silikon und doppelseitigem Klebeband fixiert werden (separat erhältlich)

Se puede fijar con silicona y adhesivo de dos caras (se vende por separado)

Может быть закреплён силиконом или использованием двухсторонней клейкой ленты (продается отдельно)

4 kg

02

Bianco
White

52

Tortora
Turtledove
grey

08

Grigio
Grey



8579

23 x 23 x 37,3 cm

Realizzati in resine termoplastiche

Made of thermoplastic resins

Réalisée en thermoplastique

Hergestellt aus Kunststoff

Realizada en resinas termoplásticas

Изготовлено из термопластических смол



100%
made in Italy

Tergivetro

Novità - New

G•GUMMY

Wiper-blade
Raclette de douche
Glasabzieher
Limpiacristales
Стеклоочиститель

02	08	14	66
Bianco White	Grigio Grey	Nero Black	Tortora chiaro Light turtledove grey



2641

22 x 3 x 23 cm

Realizzati in resine termoplastiche
Made of thermoplastic resins
Réalisée en thermoplastique
Hergestellt aus Kunststoff
Realizada en resinas termoplásticas
Изготовлено из термопластиченых смол



Tappeti antiscivolo

Non slip mats
Tapis anti antidérapants
Rutsch sichere Matten
Alfombras antideslizantes
Антискользящие коврики



Realizzati in PVC
Made of PVC
Réalisés en PVC
Hergestellt aus PVC
Realizadas en PVC
Изготовлено из ПВХ

100%
made in Italy

975858

976060

60 x 60 x 0,6 cm

60 x 60 x 0,6 cm

PER DOCCIA
FOR SHOWER

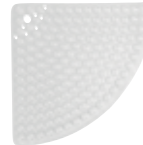

978060

971040

80 x 60 x 0,6 cm

104 x 40 x 0,6 cm



00

PER VASCA
FOR BATHTUB



Trasparente
Transparent



Realizzati in PVC
Made of PVC
Réalisés en PVC
Hergestellt aus PVC
Realizadas en PVC
Изготовлено из PVC

100%
made in Italy

975151 - G•MARGHERITA

51,5 x 51,5 cm

PER DOCCIA
FOR SHOWER

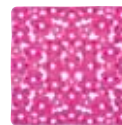

973572 - G•MARGHERITA

72 x 34,5 cm

PER VASCA
FOR BATHTUB



P0

P1

P2

P4

P8

P9

Fucsia
Fuxia

Azzurro
Light blue

Trasparente
Transparent

Arancio
Orange

Verde
Green

Lilla
Lilac



Realizzati in PVC espanso
Made of foam PVC
Réalisés en PVC expansé
Hergestellt aus verschäumtem PVC
Realizadas en espuma de PVC
Изготовлено из вспененного ПВХ

100%
made in Italy

975555 - G•TINTA UNITA

55 x 55 x 0,8 cm

PER DOCCIA
FOR SHOWER



973782 - G•TINTA UNITA

82 x 36 x 0,8 cm

PER VASCA
FOR BATHTUB



02

Bianco
White



Realizzati in PVC
Made of PVC
Réalisés en PVC
Hergestellt aus PVC
Realizadas en PVC
Изготовлено из ПВХ

TAVA403 - G•DUCK

70x35x0,5 cm

PER VASCA
FOR BATHTUB



00

Trasparente
Transparent



Realizzati in PVC
 Made of PVC
 Réalisés en PVC
 Hergestellt aus PVC
 Realizadas en PVC
 Изготовлено из ПВХ

TADO401 - G•RIVER

54 x 54 x 0,7 cm

PER DOCCIA
 FOR SHOWER



TAVA401 - G•RIVER

70 x 35 x 0,7 cm

PER VASCA
 FOR BATHTUB



00

Trasparente
 Transparent

08

Grigio
 Grey



Realizzati in PVC
 Made of PVC
 Réalisés en PVC
 Hergestellt aus PVC
 Realizadas en PVC
 Изготовлено из ПВХ

TADO400 - G•SOLID

53 x 53 x 0,7 cm

PER DOCCIA
 FOR SHOWER

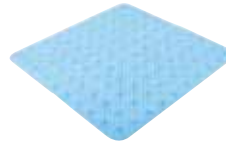

TAVA400 - G•SOLID

69 x 38,5 x 0,7 cm

PER VASCA
 FOR BATHTUB



00

Trasparente
 Transparent

02

Bianco
 White

P1

Azzurro
 trasparente
 Transparent
 light blue

P8

Verde
 trasparente
 Transparent
 green



Realizzati in PVC
 Made of PVC
 Réalisés en PVC
 Hergestellt aus PVC
 Realizadas en PVC
 Изготовлено из ПВХ

TADO402 - G•MAIM

50 x 50 x 0,4 cm

PER DOCCIA
 FOR SHOWER



TAVA402 - G•MAIM

60 x 0,4 x 38 cm

PER VASCA
 FOR BATHTUB



Novità - New

NEW

00

Trasparente
 Transparent

02

Bianco
 White

P1

Azzurro
 trasparente
 Transparent
 light blue



Realizzati in vinile
 Made of vinyl
 Réalisés en vinyl
 Hergestellt aus Vinyl
 Realizadas en vinilo
 Изготовлено из винила

CO5656 - G•PIETRA

53,5 x 1 x 53,5 cm

PER DOCCIA
 FOR SHOWER

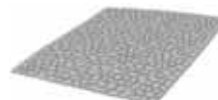

CO3475 - G•PIETRA

38 x 1 x 74,5 cm

PER VASCA
 FOR BATHTUB



02

Bianco
 White

08

Grigio
 Grey

85

Antracite
 Anthracite

**Realizzati in vinile**

Made of vinyl

Réalisés en vinyl

Hergestellt aus Vinyl

Realizadas en vinilo

Изготовлено из винила

CO5555 - G•CUORE

53 x 0,6 x 53 cm

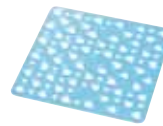
PER DOCCIA
FOR SHOWER**CO3675 - G•CUORE**

35,5 x 0,6 x 71,5 cm

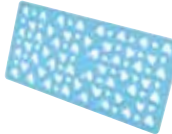
PER VASCA
FOR BATHTUBTrasparente
TransparentAzzurro
Light blue**Realizzato in gomma**

Made of rubber

Réalisé en caoutchouc

Hergestellt aus Gummi

Realizadas en goma

Изготовлено из каучука

100%
made in Italy
985555 - G•GIOTTO

54,5 x 54,5 x 0,5 cm

PER DOCCIA
FOR SHOWER**983979 - G•GIOTTO**

79 x 39,5 x 0,5 cm

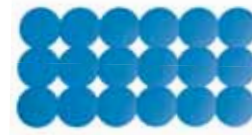
PER VASCA
FOR BATHTUBBianco
WhiteVerde acido
Acid greenAzzurro
Light blueArancio
Orange

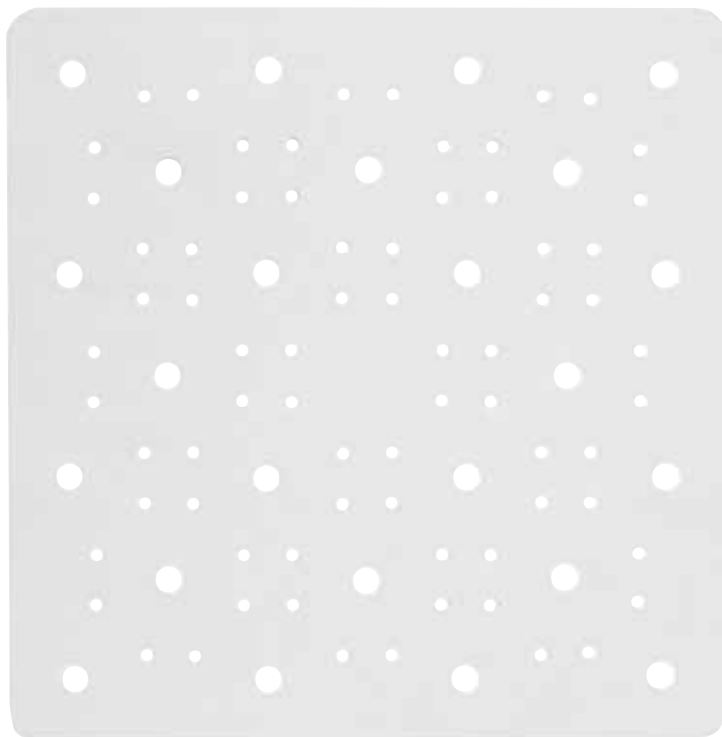

Realizzati in gomma
Made of rubber
Réalisés en caoutchouc
Hergestellt aus Gummi
Realizadas en goma
Изготовлено из каучука

100%
made in Italy

985353 - G•TINTA UNITA

52,5 x 52,5 x 0,6 cm

PER DOCCIA
FOR SHOWER



983672 - G•TINTA UNITA

71 x 36 x 0,6 cm

PER VASCA
FOR BATHTUB



02

Bianco
White



Realizzati in gomma
Made of rubber
Réalisés en caoutchouc
Hergestellt aus Gummi
Realizadas en goma
Изготовлено из каучука

100%
made in Italy

975353 - G•GEO

51,5 x 0,6 x 51,5 cm

PER DOCCIA
FOR SHOWER



973671 - G•GEO

35 x 0,6 x 68 cm

PER VASCA
FOR BATHTUB



02

Bianco
White

03

Beige
Beige

04

Verde acido
Acid green

05

Blu
Blue

11

Azzurro
Light blue

67

Arancio
Orange

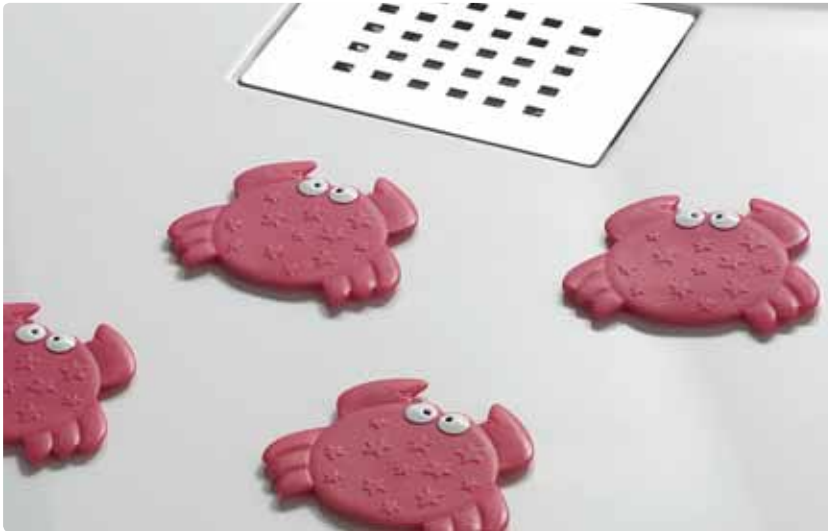

Realizzati in PVC
Made of PVC
Réalisés en PVC
Hergestellt aus PVC
Realizadas en PVC
Изготовлено из ПВХ

TANP404 - G•CRABBY

12,5X8,5X0,5 cm - 4 pz./pcs

06

Rosso
Red



Realizzati in PVC
Made of PVC
Réalisés en PVC
Hergestellt aus PVC
Realizadas en PVC
Изготовлено из ПВХ

TANP405 - G•DAISY

12,5X8,5X0,5 cm - 4 pz./pcs

10

Rosa
Pink

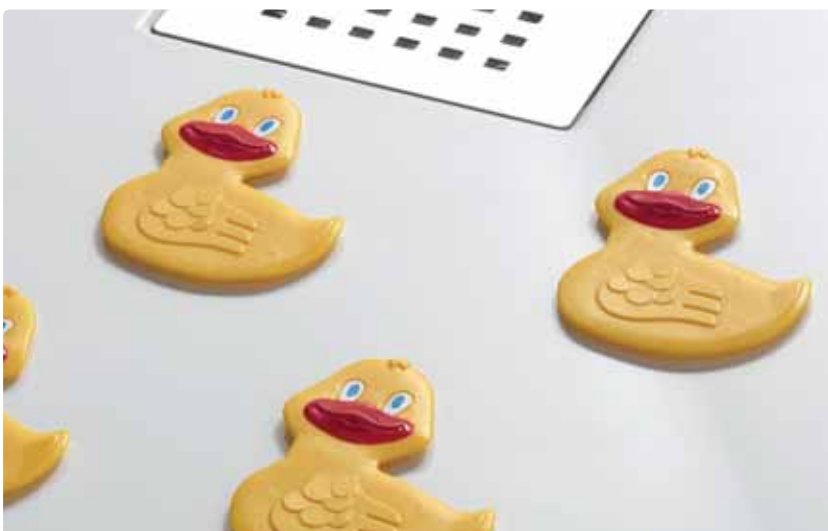

Realizzati in PVC
Made of PVC
Réalisés en PVC
Hergestellt aus PVC
Realizadas en PVC
Изготовлено из ПВХ

TANP406 - G•DUFFY

12,5X8,5X0,5 cm - 4 pz./pcs

09

Giallo
Yellow



Pedane doccia

Shower platforms
Caillebotis
Duschroste
Tarimas para ducha
Решетки для душа

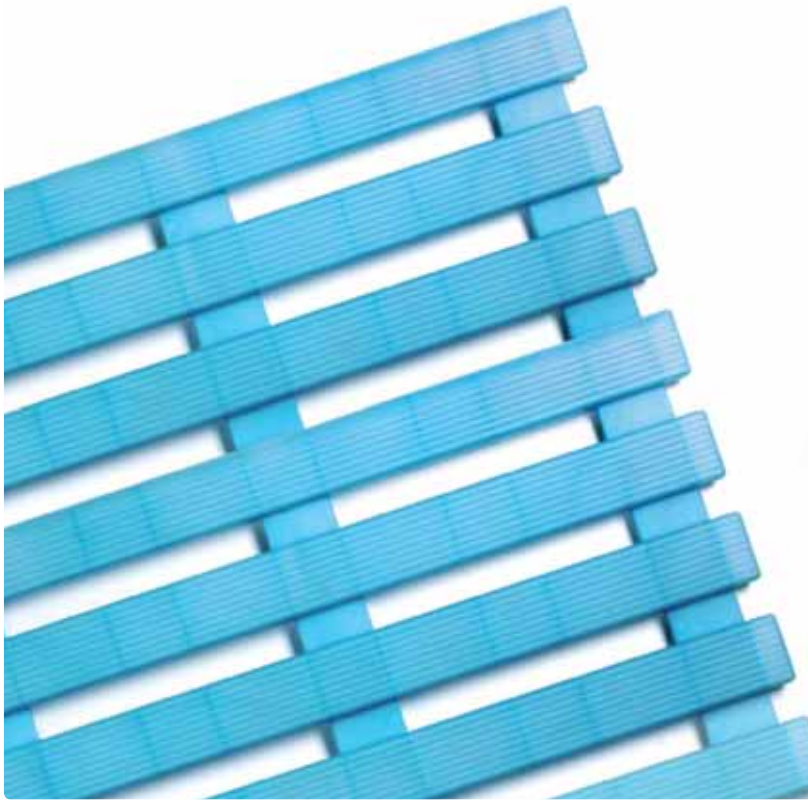

Realizzata in resine termoplastiche

Made of thermoplastic resins
Réalisé en thermoplastique
Hergestellt aus Kunststoff
Realizada en resinas termoplásticas
Изготовлено из термопластичных смол

CO83 - G•LIDO

58,2 x 57,5 x 3 cm

PER DOCCIA
FOR SHOWER



Con piedini in gomma antiscivolo

With non-slip rubber feet
Avec des pieds
en caoutchouc antidérapants
Mit rutschfesten Gummifüßen
Con pies de goma antideslizantes
С опорными ножками из нескользящей резины

02

P1

Bianco
White

Azzurro
Light blue

100%
made in Italy

Realizzata in resine termoplastiche

Made of thermoplastic resins
Réalisé en thermoplastique
Hergestellt aus Kunststoff
Realizada en resinas termoplásticas
Изготовлено из термопластичных смол

8083 - G•SPIRALE

54,5 x 2,2 x 54,5 cm

PER DOCCIA
FOR SHOWER



100%
made in Italy



02

08

52

Bianco
White

Grigio
Grey

NEW
Tortora
Turtledove
grey

Tappetino lavello

Sink-Mat - Tapis évier - Spülbeckenmatte
Alfombrilla lavabo - Коврик для раковины

Novità - New



Realizzati in PVC
Made of PVC
Réalisés en PVC
Hergestellt aus PVC
Realizadas en PVC
Изготовлено из ПВХ

TALA501 - G•STAMP

30 x 30 x 0,4 cm

TALA502 - G•STAMP

30 x 38 x 0,4 cm

TALA503 - G•STAMP

ø 30 x 0,4 cm



Trasparente
Transparent

Bianco
White

100%
made in Italy

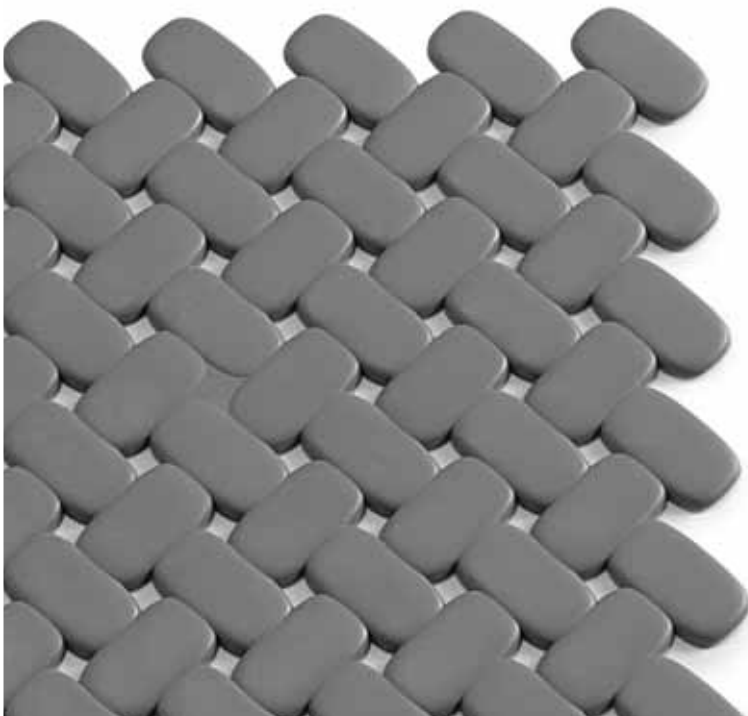
Realizzati in PVC
Made of PVC
Réalisés en PVC
Hergestellt aus PVC
Realizadas en PVC
Изготовлено из ПВХ

TALA505 - G•BRICKS

26 x 26 x 0,3 cm



Trasparente
Transparent

Grigio
Grey

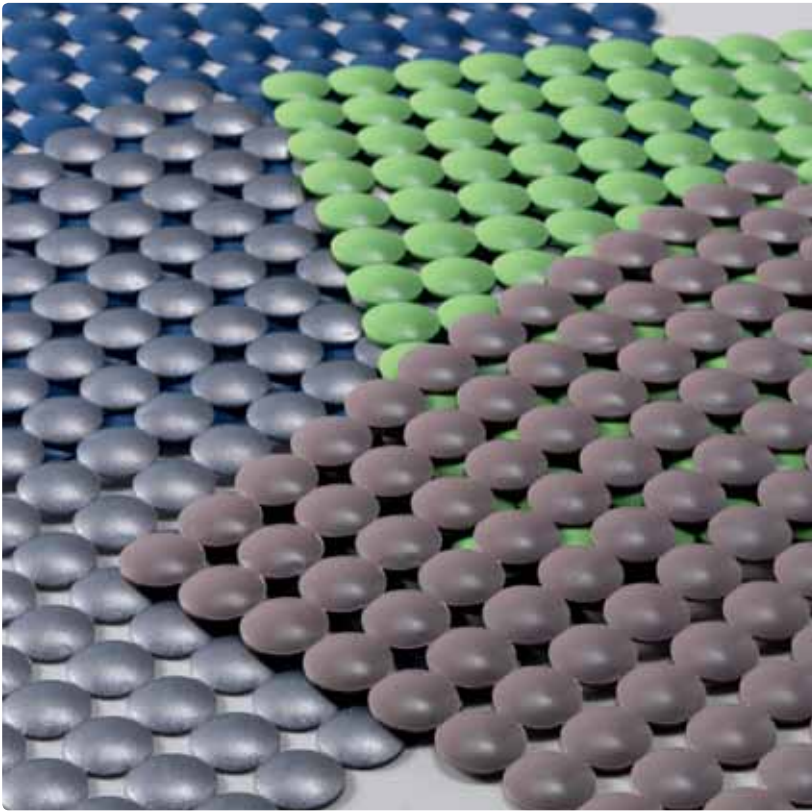

Realizzati in polipropilene

Made of polypropylene

Réalisés en polypropylène

Hergestellt aus Polypropylen

Realizadas en polipropileno

Изготовлено из полипропилена

TALA500 - G•SOAP

32 x 32 x 0,3 cm

100%
made in Italy



04

Verde acido
Acid green

05

Blu
Blue

66

Tortora
chiaro
Light
turtledove
grey

73

Argento
Silver



Realizzati in PVC

Made of PVC

Réalisés en PVC

Hergestellt aus PVC

Realizadas en PVC

Изготовлено из ПВХ

TALA504 - G•LAPIS

26 x 26 x 0,3 cm

00

Trasparente
Transparent

08

Grigio
Grey

Sedili per doccia e vasca

Shower and bath tub seats
Sièges pour douche et baignoire
Dusch- und
Badewannensitze
Asientos para ducha y bañera
Сидение в душ и ванну



6083 - G•PRIMA CLASSE

35,5 x 37 x 10,5 cm

Design: Studio Talocci



**Sedile ribaltabile per doccia
alluminio/ABS**

Shower seat - aluminum/ABS

Siège pour douche repliable
aluminium/ABS

Duschsitz hochklappbar

Aluminium/ABS

Asiento abatible para ducha

aluminio/ABS

Сиденье для ABS-пластик



02
Bianco
White



23
Bianco
cromato
White
chromed



43
Antracite
cromato
Anthracite/
chromed



2284 - G•SICURA

64 x 32,4 x 18,3 cm

**Braccioli estensibili per vasche
con misura interna di 50-65 cm**

Extendable arms for bathtubs with internal
measurement 50-60 cm

Bras extensibles pour baignoires
aux dimensions intérieures de 50-60 cm

Verlängerbare Armlehnen für Wannen
mit einem Innenmaß von 50-60 cm

Apoyabrazos extensibles para bañeras
con medidas interiores de 50-60 cm

Выдвижные поручни для ванны,
имеющей внутреннюю ширину от 50 до 60 см

Realizzato in resine termoplastiche e alluminio

Made of thermoplastic resins and aluminum

Réalisé en thermoplastique et aluminium

Hergestellt aus Kunststoff und Aluminium

Realizado en resinas termoplásticas y aluminio

Изготовлено из термопластичных смол и алюминия



02
Bianco
White

100
kg**2283 - G•SICURA**

34,5 x 34,5 x 10,5 cm

Sedile ribaltabile per doccia

Tilt-up shower seat

Siège pour douche repliable

Duschsitz hochklappbar

Asiento para ducha abatible

Откидное сиденье в душ

Realizzato in resine termoplastiche e alluminio

Made of thermoplastic resins and aluminum

Réalisé en thermoplastique et aluminium

Hergestellt aus Kunststoff und Aluminium

Realizado en resinas termoplásticas y aluminio

Изготовлено из термопластичных смол и алюминия

02

Bianco
WhiteTEST CONDOTTI DALL'ISTITUTO DI CERTIFICAZIONE QUALITÀ CABIATE (CO)
TESTED BY ISTITUTO DI CERTIFICAZIONE QUALITÀ CABIATE (CO)120
kg**2282 - G•SOUND**

38,5 x 35,4 x 15,2 cm

Sedile ribaltabile per doccia

Tilt-up shower seat

Siège pour douche repliable

Duschsitz hochklappbar

Asiento para ducha abatible

Откидное сиденье в душ

Realizzato in resine termoplastiche e acciaio

Made of thermoplastic resins and steel

Réalisé en thermoplastique et acier

Hergestellt aus Kunststoff und Stahl

Realizado en resinas termoplásticas y acero

Изготовлено из термопластичных смол и стали



02

Bianco
White

23

Bianco/cromato
White/chromedTEST CONDOTTI DALL'ISTITUTO DI CERTIFICAZIONE QUALITÀ CABIATE (CO)
TESTED BY ISTITUTO DI CERTIFICAZIONE QUALITÀ CABIATE (CO)120
kg**DI82 - G•DINO**

37,5 x 29,5 x 7 cm

Sedile ribaltabile per doccia

Tilt-up shower seat

Siège pour douche repliable

Duschsitz hochklappbar

Asiento para ducha abatible

Откидное сидение в душ

Realizzato in resine termoplastiche

Thermoplastic resins

Réalisé en thermoplastique

Hergestellt aus Kunststoff

Realizado en resinas termoplásticas

Изготовлено из термопластичных смол

02

Bianco
White

Tende doccia

Shower curtains - Rideaux de douche
Duschvorhänge - Cortinas de baño - Занавески для ванной

Tende doccia in TESSUTO

SIMBOLOGIA



100% poliestere impermeabilizzato - 100% waterproof polyester - 100% polyester imperméable - 100% Polyester wasserfest
100% poliester impermeabilizado - 100% водонепроницаемый полиэстер

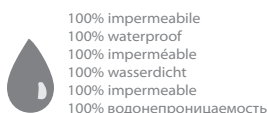

100% impermeabile
100% waterproof
100% imperméable
100% wasserdicht
100% impermeable
100% водонепроницаемость



Occhielli in ottone
Brass eyelets
Oeillets en laiton
Messing Ösen
Ojales de latón
Латунные проушины



Cucita ai lati (no sfilacciamenti)
Its sides are sewed to avoid fraying
Cousue sur les côtés (sans effilochages)
An den Seiten genäht (kein Ausfransen)
Cosida en los laterales (no se deshilacha)
Боковые отстрочки (во избежание разлохмачивания кромок)



Le tende doccia Gedy in tessuto sono realizzate in Poliestere al 100% e trattate per renderle impermeabili e resistenti alle macchie. Il tessuto ed i colori utilizzati sono certificati come completamente atossici. L'orlo inferiore contiene un filo di polipropilene per mantenere la tenda in ordine e sempre tesa. La tenda è fornita completa di anelli. Ogni tenda è garantita per 3 anni.

Les rideaux de douche en tissu de Gedy sont fabriqués en 100% Polyester, ils sont traités à la résine pour les rendre imperméables et résistants aux taches. Le tissu et les couleurs utilisés sont certifiés non-toxiques. L'ourlet en bas contient un fil de polypropylène pour maintenir le rideau rangé et toujours tendu. Le rideau de douche est livré avec anneaux. Chaque rideau est garanti 3 ans.

Las cortinas de baño de tejido Gedy están hechas de 100% poliéster y están tratadas para que sean impermeables y resistentes a las manchas. El tejido y los colores utilizados están certificados como completamente no tóxicos. El borde inferior contiene un hilo de polipropileno para que la cortina esté siempre en orden y extendida. La cortina se suministra con anillas. Todas las cortinas tienen una garantía de 3 años.

Gedy fabric shower curtains are made in Polyester 100% treated with waterproof resin. The raw materials and colours are certified as completely non-toxic. Into the hem there is a polypropylene thread that keeps the curtains always tidy and tight. All curtains are supplied with rings. Each shower curtain features a 3-year warranty.

Gedy Textil-Duschvorhänge bestehen aus 100% Polyester und sind imprägniert und wasser- und schmutzabweisend. Die verwendeten Stoffe und Farben sind als vollständig ungiftig und entsprechend zertifiziert. Im unteren Saum befindet sich ein Beschwerungsband aus Polypropylen, das dafür sorgt, dass der Duschvorhang immer ordentlich bleibt und nach unten fällt. Der Duschvorhang wird komplett mit Vorhangringen geliefert. Jeder Duschvorhang verfügt über 3 Jahre Garantie.

Занавески из ткани Gedy изготовлены из 100% полиэстера с защитной обработкой для обеспечения водонепроницаемости и стойкости к образованию пятен. Используемая ткань и краски прошли сертификацию как полностью нетоксичные. Нижняя кромка с полипропиленовой нитью для поддержания натяжения. К занавеске прилагаются крючки. Каждая занавеска имеет гарантию 3 года.



G•NEVE

JACQUARD



cod. 1328
Bianco
White
Blanc
Weiss
Blanco
Белый

cm. 120 x 200 **TTE 1328 1230**

cm. 180 x 200 **TTE 1328 1830**

cm. 240 x 200 **TTE 1328 2430**

Anelli inclusi - Rings included
Anneaux fournis - Ringe enthalten
Anillas incluidas - Кольца включены



G•SPIRAGLIO



cod. 1310
Bianco/Trasparente
White/Transparent
Blanc/Transparent
Weiss/Durchsichtig
Blanco/Transparente
Белый/прозрачный

cm. 120 x 200 **TTE 1310 1230**

cm. 180 x 200 **TTE 1310 1830**

cm. 240 x 200 **TTE 1310 2430**

Decoro trasparente in PEVA
With transparent decoration in PEVA

Anelli incorporati
Built-in rings
Anneaux intégrés
Eingebaute Ringe
Anillos incorporados
Кольца включены





G•BASIC



cod. 1000
Bianco
White
Blanc
Weiss
Blanco
Белый



cod. 1001
Azzurro
Light blue
Bleu ciel
Hellblau
Azul celeste
Голубой

cm. 180 x 200 **TTE 1000 1830**

cm. 180 x 200 **TTE 1001 1830**

Anelli inclusi - Rings included
Anneaux fournis - Ringe enthalten
Anillas incluidas - Кольца включены



G•VANIGLIA

Novità - New



cod. 1003
Bianco
White
Blanc
Weiss
Blanco
Белый

cm. 120 x 200 **TVI 1003 1230**

cm. 180 x 200 **TVI 1003 1830**

cm. 240 x 200 **TVI 1003 2430**

Anelli inclusi - Rings included
Anneaux fournis - Ringe enthalten
Anillas incluidas - Кольца включены





G•ARALDICA



cod. 1325
Beige
Beige
Beige
Beige
Beige
Цвет

cm. 120 x 200 **TTE 1325 1230**

cm. 180 x 200 **TTE 1325 1830**

cm. 240 x 200 **TTE 1325 2430**

Anelli inclusi - Rings included
Anneaux fournis - Ringe enthalten
Anillas incluidas - Кольца включены



G•CAFFÈ



cod. 1302
Bianco/beige/marrone
White/beige/brown
Blanc/beige/marron
Weiss/beige/braun
Blanco/beige/marrón
Белый/цвет шампанского/коричневый

cm. 120 x 200 **TTE 1302 1230**

cm. 180 x 200 **TTE 1302 1830**

cm. 240 x 200 **TTE 1302 2430**

Anelli inclusi - Rings included
Anneaux fournis - Ringe enthalten
Anillas incluidas - Кольца включены





G•CIELO



cod. 1327
Celeste
Sky-blue
Blue
Himmelblau
Celeste
Голубой

cm. 120 x 200 **TTE 1327 1230**

cm. 180 x 200 **TTE 1327 1830**

cm. 240 x 200 **TTE 1327 2430**

Anelli inclusi - Rings included
Anneaux fournis - Ringe enthalten
Anillas incluidas - Кольца включены



G•DESIDERIO



cod. 1355
Bianco/nero
White/black
Blanc/noir
Weiss/schwarz
Blanco/negro
Черный/белый

cm. 120 x 200 **TTE 1355 1230**

cm. 180 x 200 **TTE 1355 1830**

cm. 240 x 200 **TTE 1355 2430**

Anelli inclusi - Rings included
Anneaux fournis - Ringe enthalten
Anillas incluidas - Кольца включены





G•ELEGANCE



cod. 1316
Bianco/grigio/nero
White/grey/black
Blanc/gris/noir
Weiss/grau/schwarz
Blanco/gris/negro
Черный/серый/белый

cm. 120 x 200 **TTE 1316 1230**

cm. 180 x 200 **TTE 1316 1830**

cm. 240 x 200 **TTE 1316 2430**

Anelli inclusi - Rings included
Anneaux fournis - Ringe enthalten
Anillas incluidas - Кольца включены



G•EUCALIPTO



cod. 1304
Verde
Green
Vert
Grün
Verde
Зелёный

cm. 120 x 200 **TTE 1304 1230**

cm. 180 x 200 **TTE 1304 1830**

cm. 240 x 200 **TTE 1304 2430**

Anelli inclusi - Rings included
Anneaux fournis - Ringe enthalten
Anillas incluidas - Кольца включены





G•FLORA



cod. 1320
Rosa/giallo
Pink/yellow
Rose/jaune
Rosa/gelb
Rosa/amarillo
Розовый/желтый

cm. 120 x 200 **TTE 1320 1230**

cm. 180 x 200 **TTE 1320 1830**

cm. 240 x 200 **TTE 1320 2430**

Anelli inclusi - Rings included
Anneaux fournis - Ringe enthalten
Anillas incluidas - Кольца включены



G•FRAMMENTI



cod. 1315
Blu
Blue
Bleu
Blau
Azulón
Синий

cm. 120 x 200 **TTE 1315 1230**

cm. 180 x 200 **TTE 1315 1830**

cm. 240 x 200 **TTE 1315 2430**

Anelli inclusi - Rings included
Anneaux fournis - Ringe enthalten
Anillas incluidas - Кольца включены





G•FRENESIA



cod. 1303
 Rosa/giallo/turchese
 Pink/yellow/turquoise
 Rose/jaune/turquoise
 Rosa/gelb/türkis
 Rosa/amarillo/turquesa
 Розовый/желтый/брюзовый цвет

cm. 120 x 200 **TTE 1303 1230**

cm. 180 x 200 **TTE 1303 1830**

cm. 240 x 200 **TTE 1303 2430**

Anelli inclusi - Rings included
 Anneaux fournis - Ringe enthalten
 Anillas incluidas - Кольца включены



G•FRIZZ



cod. 1313
 Blu
 Blue
 Bleu
 Blau
 Azulón
 Синий

cm. 120 x 200 **TTE 1313 1230**

cm. 180 x 200 **TTE 1313 1830**

cm. 240 x 200 **TTE 1313 2430**

Anelli inclusi - Rings included
 Anneaux fournis - Ringe enthalten
 Anillas incluidas - Кольца включены





G•GOMITOLO



cod. 1326
Verde/marrone
Green/brown
Vert/marron
Grün/braun
Verde/marrón
Зелёный/коричневый

cm. 120 x 200 **TTE 1326 1230**

cm. 180 x 200 **TTE 1326 1830**

cm. 240 x 200 **TTE 1326 2430**

Anelli inclusi - Rings included
Anneaux fournis - Ringe enthalten
Anillas incluidas - Кольца включены

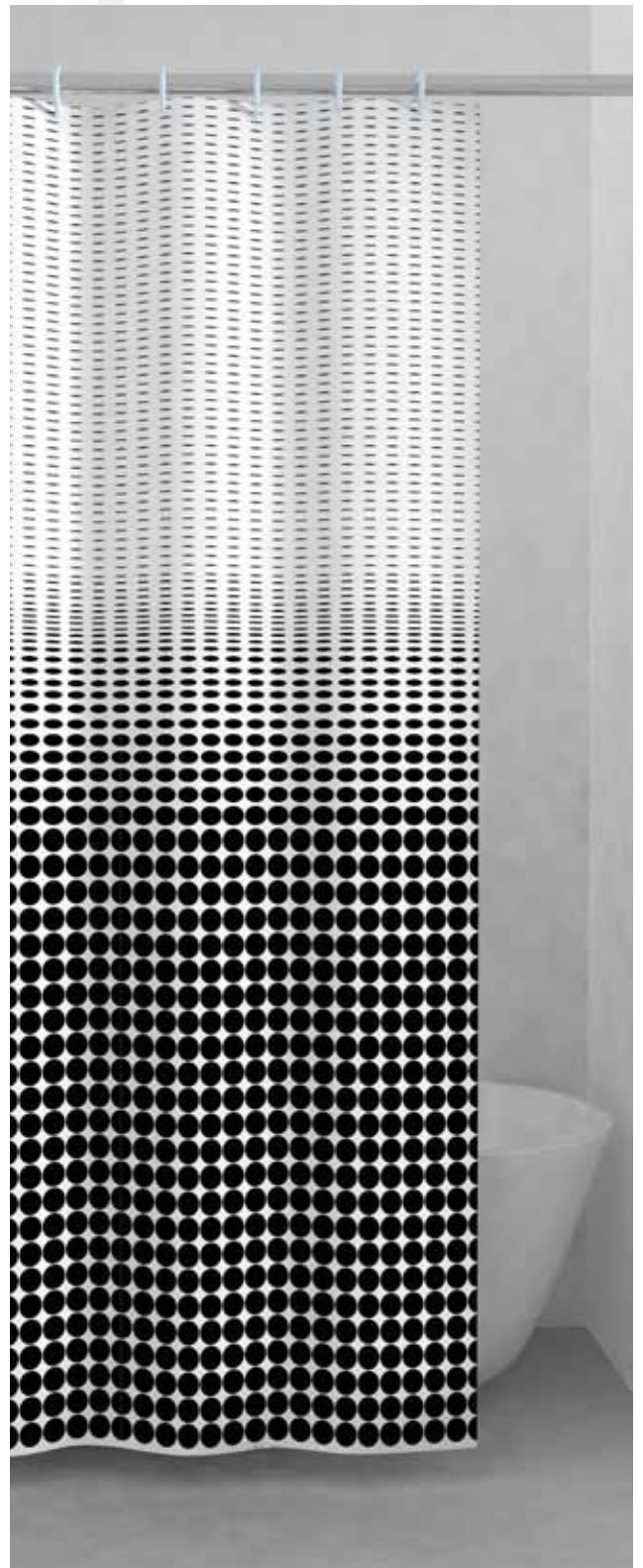

G•IPNOSI



cod. 1314
Bianco/nero
White/black
Blanc/noir
Weiss/schwarz
Blanco/negro
Чёрный/белый

cm. 120 x 200 **TTE 1314 1230**

cm. 180 x 200 **TTE 1314 1830**

cm. 240 x 200 **TTE 1314 2430**

Anelli inclusi - Rings included
Anneaux fournis - Ringe enthalten
Anillas incluidas - Кольца включены



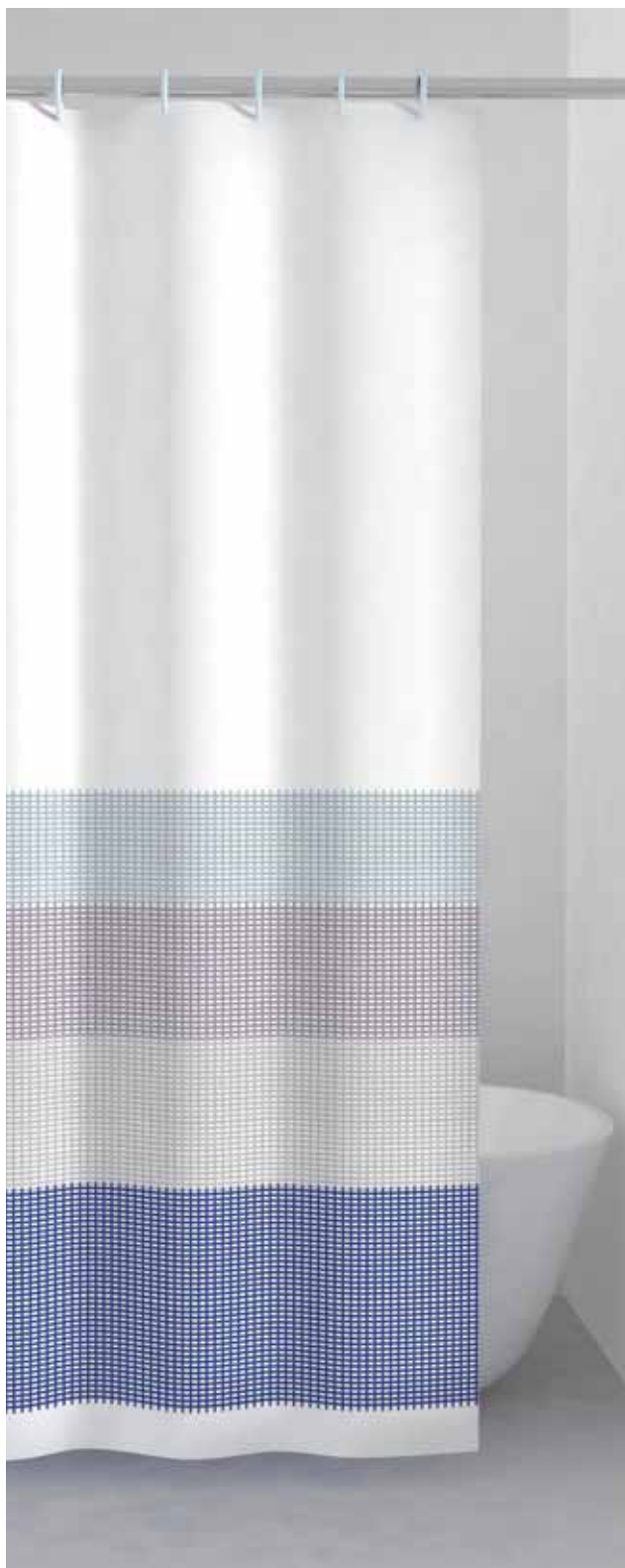

G•JEANS



cod. 1307
 Multicolore
 Multicolor
 Multicolore
 Mehrfarbig
 Multicolor
 Разноцветный

cm. 120 x 200 **TTE 1307 1230**

cm. 180 x 200 **TTE 1307 1830**

cm. 240 x 200 **TTE 1307 2430**

Anelli inclusi - Rings included
 Anneaux fournis - Ringe enthalten
 Anillas incluidas - Кольца включены



G•LADY MARY



cod. 1305
 Grigio/Rosa
 Grey/Pink
 Gris/Rose
 Grau/Rosa
 Gris/Rosa
 Серый/Розовый

cm. 120 x 200 **TTE 1305 1230**

cm. 180 x 200 **TTE 1305 1830**

cm. 240 x 200 **TTE 1305 2430**

Anelli inclusi - Rings included
 Anneaux fournis - Ringe enthalten
 Anillas incluidas - Кольца включены





G•LIVING



cod. 1323
 Beige/bianco/nero
 Beige/white/black
 Beige/blanc/noir
 Beige/weiss/schwarz
 Beige/blanco/negro
 бежевый/черный/белый

cm. 120 x 200 **TTE 1323 1230**

cm. 180 x 200 **TTE 1323 1830**

cm. 240 x 200 **TTE 1323 2430**

Anelli inclusi - Rings included
 Anneaux fournis - Ringe enthalten
 Anillas incluidas - Кольца включены



G•OLTREMARE



cod. 1306
 Beige/azzurro
 Beige/light blue
 Beige/bleu ciel
 Beige/Hellblau
 Beige/azul celeste
 бежевый/Голубой

cm. 120 x 200 **TTE 1306 1230**

cm. 180 x 200 **TTE 1306 1830**

cm. 240 x 200 **TTE 1306 2430**

Anelli inclusi - Rings included
 Anneaux fournis - Ringe enthalten
 Anillas incluidas - Кольца включены





G•ORIZZONTI



cod. 1301
Celeste
Sky-blue
Bleu ciel
Himmelblau
Celeste
Голубой

cm. 120 x 200 **TTE 1301 1230**

cm. 180 x 200 **TTE 1301 1830**

cm. 240 x 200 **TTE 1301 2430**

Anelli inclusi - Rings included
Anneaux fournis - Ringe enthalten
Anillas incluidas - Кольца включены



G•PARALLELE



cod. 1321
Grigio
Grey
Gris
Grau
Gris
Серый

cm. 120 x 200 **TTE 1321 1230**

cm. 180 x 200 **TTE 1321 1830**

cm. 240 x 200 **TTE 1321 2430**

Anelli inclusi - Rings included
Anneaux fournis - Ringe enthalten
Anillas incluidas - Кольца включены





G•PARFUME



cod. 1322
Bianco/nero
White/black
Blanc/noir
Weiss/schwarz
Blanco/negro
Черный/белый

cm. 120 x 200 **TTE 1322 1230**

cm. 180 x 200 **TTE 1322 1830**

cm. 240 x 200 **TTE 1322 2430**

Anelli inclusi - Rings included
Anneaux fournis - Ringe enthalten
Anillas incluidas - Кольца включены



G•PIPER



cod. 1318
Beige/nero
Beige/black
Beige/noir
Beige/schwarz
Beige/negro
бежевый/белый

cm. 120 x 200 **TTE 1318 1230**

cm. 180 x 200 **TTE 1318 1830**

cm. 240 x 200 **TTE 1318 2430**

Anelli inclusi - Rings included
Anneaux fournis - Ringe enthalten
Anillas incluidas - Кольца включены





G•RICORDI



cod. 1324
Celeste/turchese/nero
Sky-blue/turquoise/black
Bleu/turquoise/noir
Himmelblau/türkis/schwarz
Celeste/turquesa/negro
Голубой/брюзовый цвет/белый

cm. 120 x 200 **TTE 1324 1230**

cm. 180 x 200 **TTE 1324 1830**

cm. 240 x 200 **TTE 1324 2430**

Anelli inclusi - Rings included
Anneaux fournis - Ringe enthalten
Anillas incluidas - Кольца включены



G•RIVA



cod. 1309
Blu
Blue
Bleu
Blau
Azulón
Синий

cm. 120 x 200 **TTE 1309 1230**

cm. 180 x 200 **TTE 1309 1830**

cm. 240 x 200 **TTE 1309 2430**

Anelli inclusi - Rings included
Anneaux fournis - Ringe enthalten
Anillas incluidas - Кольца включены





G•SPIAGGIA



cod. 1317
Beige/marrone
Beige/brown
Beige/marron
Beige/braun
Beige/marrón
Бежевый/коричневый

cm. 120 x 200 **TTE 1317 1230**

cm. 180 x 200 **TTE 1317 1830**

cm. 240 x 200 **TTE 1317 2430**

Anelli inclusi - Rings included
Anneaux fournis - Ringe enthalten
Anillas incluidas - Кольца включены



G•STANCIL



cod. 1319
Grigio
Grey
Gris
Gru
Gris
Серый

cm. 120 x 200 **TTE 1319 1230**

cm. 180 x 200 **TTE 1319 1830**

cm. 240 x 200 **TTE 1319 2430**

Anelli inclusi - Rings included
Anneaux fournis - Ringe enthalten
Anillas incluidas - Кольца включены



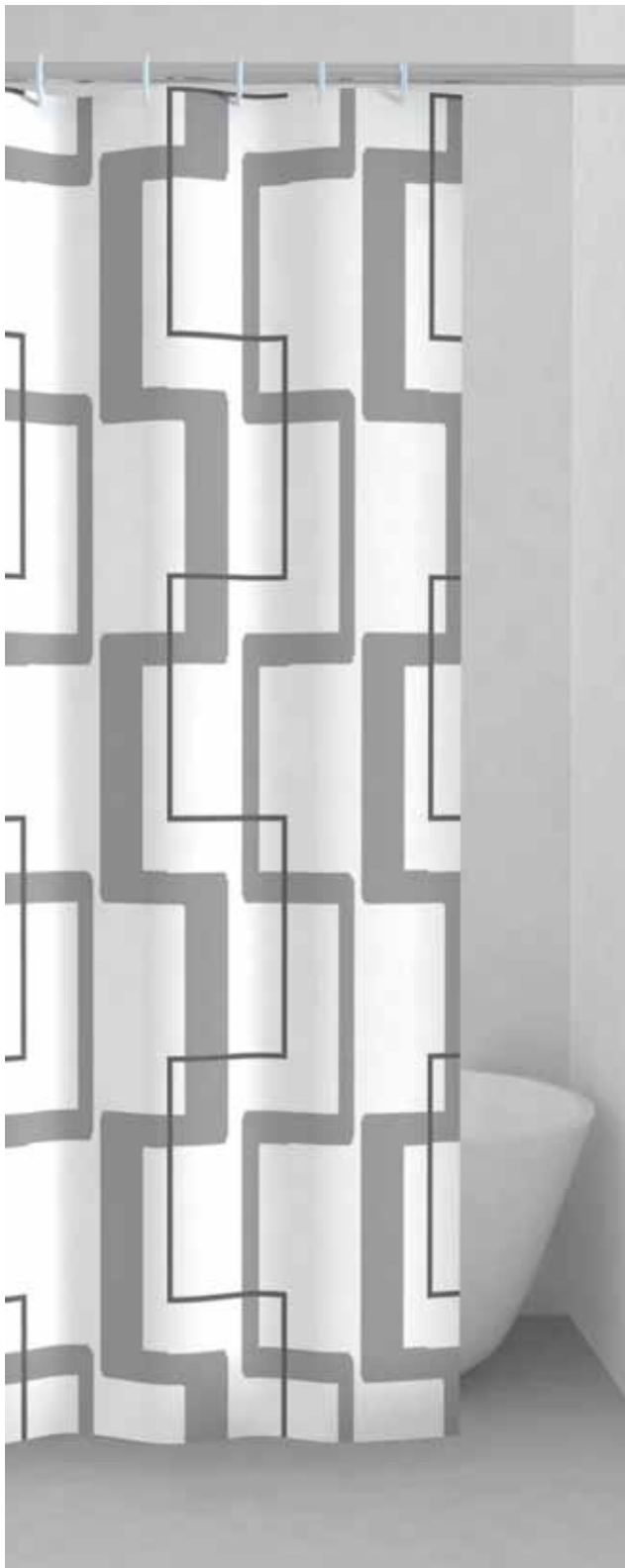

G•TECNO



cod. 1308
Grigio
Grey
Gris
Grau
Gris
Серый

cm. 120 x 200 **TTE 1308 1230**

cm. 180 x 200 **TTE 1308 1830**

cm. 240 x 200 **TTE 1308 2430**

Anelli inclusi - Rings included
Anneaux fournis - Ringe enthalten
Anillas incluidas - Кольца включены



G•TRATTO



cod. 1312
Celeste/turchese
Sky-blue/turquoise
Bleu/turquoise
Himmelblau/türkis
Celeste/turquesa
Голубой/брюзовый цвет

cm. 120 x 200 **TTE 1312 1230**

cm. 180 x 200 **TTE 1312 1830**

cm. 240 x 200 **TTE 1312 2430**

Anelli inclusi - Rings included
Anneaux fournis - Ringe enthalten
Anillas incluidas - Кольца включены





G•VIVAIO



cod. 1311
Verde
Green
Vert
Grün
Verde
Зелёный

cm. 120 x 200 **TTE 1311 1230**

cm. 180 x 200 **TTE 1311 1830**

cm. 240 x 200 **TTE 1311 2430**

Anelli inclusi - Rings included
Anneaux fournis - Ringe enthalten
Anillas incluidas - Кольца включены



Tende doccia

Shower curtains - Rideaux de douche
Duschvorhänge - Cortinas de baño - Занавески для ванной

SIMBOLOGIA



Tende doccia in PEVA

Il PEVA è un materiale ecologico riciclabile senza dispersione di sostanze tossiche nell'ambiente. Completamente inodore - Spessore consistente per evitare che la tenda aderisca al corpo durante la doccia. La tenda è fornita completa di anelli.

Le PEVA est un matériau écologique recyclable sans dispersion de substances toxiques dans l'environnement - complètement inodore - grande épaisseur pour éviter que le rideau n'adhère au corps pendant la douche. Le rideau de douche est livré avec anneaux.

El PEVA es un material ecológico reciclable sin dispersión de sustancias tóxicas en el medio ambiente - completamente inodoro - de gran grosor para evitar que la cortina se adhiera al cuerpo durante la ducha. La cortina se suministra con anillas.

PEVA is an eco-friendly material that can be recycled without leaking toxic substances into the environment - completely odour free - and featuring adequate thickness to prevent the curtain from sticking to the body when showering. All curtains are supplied with rings.

PEVA ist ein ökologisches Material, das sich recyceln lässt, ohne dass giftige Stoffe in die Umwelt gelangen - völlig geruchlos - dickes Material, um zu verhindern, dass der Vorhang beim Duschen am Körper haften bleibt. Der Duschvorhang wird mit Vorhangringen geliefert.

PEVA - это экологичный рециклируемый материал, не выделяющий вредных веществ в окружающую среду - абсолютно лишен запаха - повышенная плотность во избежание прилипания шторки к телу во время принятия душа. К занавеске прилагаются крючки.

G•ICE
**DECORO 3D
3D PATTERN**

cod. 1357
Bianco
White
Blanc
Weiss
Blanco
Белый

cm. 180 x 200 **TVI 1357 1830**

Anelli inclusi - Rings included
Anneaux fournis - Ringe enthalten
Anillas incluidas - Кольца включены

G•SQUARE
**DECORO 3D
3D PATTERN**

cod. 1358
Bianco
White
Blanc
Weiss
Blanco
Белый



cod. 1359
Azzurro
Light blue
Bleu ciel
Hellblau
Azul celeste
Голубой

cm. 180 x 200 **TVI 1358 1830**
cm. 180 x 200 **TVI 1359 1830**

Anelli inclusi - Rings included
Anneaux fournis - Ringe enthalten
Anillas incluidas - Кольца включены





G•VETRO

**DECORO 3D
3D PATTERN**



cod. 1356
Bianco
White
Blanc
Weiss
Blanco
Белый

cm. 180 x 200 **TVI 1356 1830**

Anelli inclusi - Rings included
Anneaux fournis - Ringe enthalten
Anillas incluidas - Кольца включены



G•BASIC



cod. 1000
Bianco
White
Blanc
Weiss
Blanco
Белый



cod. 1001
Azzurro
Light blue
Bleu ciel
Hellblau
Azul celeste
Голубой

cm. 180 x 200 **TVI 1000 1830**
cm. 180 x 200 **TVI 1001 1830**

Anelli inclusi - Rings included
Anneaux fournis - Ringe enthalten
Anillas incluidas - Кольца включены





G•ZUCCHERO

Novità - New



cod. 1002
Bianco
White
Blanc
Weiss
Blanco
Белый

cm. 120 x 200 **TTE 1002 1230**

cm. 180 x 200 **TTE 1002 1830**

cm. 240 x 200 **TTE 1002 2430**

Anelli inclusi - Rings included
Anneaux fournis - Ringe enthalten
Anillas incluidas - Кольца включены



G•BIGLIE



cod. 1341
Verde/blu
Green/blue
Vert/bleu
Grün/Blau
Verde/azulón
Зелёный/синий

cm. 120 x 200 **TVI 1341 1230**

cm. 180 x 200 **TVI 1341 1830**

cm. 240 x 200 **TVI 1341 2430**

Anelli inclusi - Rings included
Anneaux fournis - Ringe enthalten
Anillas incluidas - Кольца включены





G•CIOTOLI



cod. 1344
Azzurro
Light blue
Bleu ciel
Hellblau
Azul celeste
Голубой

cm. 120 x 200 **TVI 1344 1230**

cm. 180 x 200 **TVI 1344 1830**

cm. 240 x 200 **TVI 1344 2430**

Anelli inclusi - Rings included
Anneaux fournis - Ringe enthalten
Anillas incluidas - Кольца включены



G•CIRCLES



cod. 1351
Grigio/aquamarina
Grey/aquamarine
Gris/eau verte
Grau/aquamarinblau
Gris/aquamarina
Серый/аквамарин

cm. 120 x 200 **TVI 1351 1230**

cm. 180 x 200 **TVI 1351 1830**

cm. 240 x 200 **TVI 1351 2430**

Anelli inclusi - Rings included
Anneaux fournis - Ringe enthalten
Anillas incluidas - Кольца включены





G•DOMINO



cod. 1329
Grigio
Grey
Gris
Grau
Gris
Серый

cm. 120 x 200 **TVI 1329 1230**

cm. 180 x 200 **TVI 1329 1830**

cm. 240 x 200 **TVI 1329 2430**

Anelli inclusi - Rings included
Anneaux fournis - Ringe enthalten
Anillas incluidas - Кольца включены



G•FOLIAGE



cod. 1353
Grigio
Grey
Gris
Grau
Gris
Серый

cm. 120 x 200 **TVI 1353 1230**

cm. 180 x 200 **TVI 1353 1830**

cm. 240 x 200 **TVI 1353 2430**

Anelli inclusi - Rings included
Anneaux fournis - Ringe enthalten
Anillas incluidas - Кольца включены





G•FRAME



cod. 1349
Azzurro/grigio
Light blue/grey
Bleu ciel/gris
Hellblau/grau
Azul celeste/gris
Голубой/серый

cm. 120 x 200 **TVI 1349 1230**

cm. 180 x 200 **TVI 1349 1830**

cm. 240 x 200 **TVI 1349 2430**

Anelli inclusi - Rings included
Anneaux fournis - Ringe enthalten
Anillas incluidas - Кольца включены



G•FRAMMENTI



cod. 1315
Azzurro
Light blue
Bleu ciel
Hellblau
Azul celeste
Голубой

cm. 120 x 200 **TVI 1315 1230**

cm. 180 x 200 **TVI 1315 1830**

cm. 240 x 200 **TVI 1315 2430**

Anelli inclusi - Rings included
Anneaux fournis - Ringe enthalten
Anillas incluidas - Кольца включены





G•INCANTO



cod. 1352
 Grigio
 Grey
 Gris
 Grau
 Gris
 Серый

cm. 120 x 200 **TVI 1352 1230**

cm. 180 x 200 **TVI 1352 1830**

cm. 240 x 200 **TVI 1352 2430**

Anelli inclusi - Rings included
 Anneaux fournis - Ringe enthalten
 Anillas incluidas - Кольца включены



G•JUMP



cod. 1331
 Azzurro
 Light blue
 Bleu ciel
 Hellblau
 Azul celeste
 Голубой

cm. 120 x 200 **TVI 1331 1230**

cm. 180 x 200 **TVI 1331 1830**

cm. 240 x 200 **TVI 1331 2430**

Anelli inclusi - Rings included
 Anneaux fournis - Ringe enthalten
 Anillas incluidas - Кольца включены





G•JUNGLE



cod. 1342
Bianco
White
Blanc
Weiss
Blanco
Белый

cm. 120 x 200 **TVI 1342 1230**

cm. 180 x 200 **TVI 1342 1830**

cm. 240 x 200 **TVI 1342 2430**

Anelli inclusi - Rings included
Anneaux fournis - Ringe enthalten
Anillas incluidas - Кольца включены



G•LENS



cod. 1346
Bianco
White
Blanc
Weiss
Blanco
Белый

cm. 120 x 200 **TVI 1346 1230**

cm. 180 x 200 **TVI 1346 1830**

cm. 240 x 200 **TVI 1346 2430**

Anelli inclusi - Rings included
Anneaux fournis - Ringe enthalten
Anillas incluidas - Кольца включены





G•LIANE



cod. 1343
 Multicolore
 Multicolor
 Multicolore
 Mehrfarbig
 Multicolor
 Разноцветный

cm. 120 x 200 **TVI 1343 1230**

cm. 180 x 200 **TVI 1343 1830**

cm. 240 x 200 **TVI 1343 2430**

Anelli inclusi - Rings included
 Anneaux fournis - Ringe enthalten
 Anillas incluidas - Кольца включены



G•NIDI



cod. 1333
 Grigio
 Grey
 Gris
 Grau
 Gris
 Серый

cm. 120 x 200 **TVI 1333 1230**

cm. 180 x 200 **TVI 1333 1830**

cm. 240 x 200 **TVI 1333 2430**

Anelli inclusi - Rings included
 Anneaux fournis - Ringe enthalten
 Anillas incluidas - Кольца включены





G•OBLÒ



cod. 1348
Azzurro
Light blue
Bleu ciel
Hellblau
Azul celeste
Голубой

cm. 120 x 200 **TVI 1348 1230**

cm. 180 x 200 **TVI 1348 1830**

cm. 240 x 200 **TVI 1348 2430**

Anelli inclusi - Rings included
Anneaux fournis - Ringe enthalten
Anillas incluidas - Кольца включены



G•ORBITA



cod. 1340
Azzurro
Light blue
Bleu ciel
Hellblau
Azul celeste
Голубой

cm. 120 x 200 **TVI 1340 1230**

cm. 180 x 200 **TVI 1340 1830**

cm. 240 x 200 **TVI 1340 2430**

Anelli inclusi - Rings included
Anneaux fournis - Ringe enthalten
Anillas incluidas - Кольца включены





G•PARADISE



cod. 1347
 Multicolore
 Multicolor
 Multicolore
 Mehrfarbig
 Multicolor
 Разноцветный

cm. 120 x 200 **TVI 1347 1230**

cm. 180 x 200 **TVI 1347 1830**

cm. 240 x 200 **TVI 1347 2430**

Anelli inclusi - Rings included
 Anneaux fournis - Ringe enthalten
 Anillas incluidas - Кольца включены



G•PARTY



cod. 1330
 Multicolore
 Multicolor
 Multicolore
 Mehrfarbig
 Multicolor
 Разноцветный

cm. 120 x 200 **TVI 1330 1230**

cm. 180 x 200 **TVI 1330 1830**

cm. 240 x 200 **TVI 1330 2430**

Anelli inclusi - Rings included
 Anneaux fournis - Ringe enthalten
 Anillas incluidas - Кольца включены





G•POOL



cod. 1332
Azzurro
Light blue
Bleu ciel
Hellblau
Azul celeste
Голубой

cm. 120 x 200 **TVI 1332 1230**

cm. 180 x 200 **TVI 1332 1830**

cm. 240 x 200 **TVI 1332 2430**

Anelli inclusi - Rings included
Anneaux fournis - Ringe enthalten
Anillas incluidas - Кольца включены



G•POT POURRI



cod. 1336
Lilla/rosa
Lilla/pink
Lilas/Rose
Lilas/rosa
Fieder/rosa
Сиреневый/розовый

cm. 120 x 200 **TVI 1336 1230**

cm. 180 x 200 **TVI 1336 1830**

cm. 240 x 200 **TVI 1336 2430**

Anelli inclusi - Rings included
Anneaux fournis - Ringe enthalten
Anillas incluidas - Кольца включены





G•PRISMA



cod. 1350
 Bianco
 White
 Blanc
 Weiss
 Blanco
 Белый

cm. 120 x 200 **TVI 1350 1230**

cm. 180 x 200 **TVI 1350 1830**

cm. 240 x 200 **TVI 1350 2430**

Anelli inclusi - Rings included
 Anneaux fournis - Ringe enthalten
 Anillas incluidas - Кольца включены



G•RUGIADA



cod. 1338
 Azzurro
 Light blue
 Bleu ciel
 Hellblau
 Azul celeste
 Голубой

cm. 120 x 200 **TVI 1338 1230**

cm. 180 x 200 **TVI 1338 1830**

cm. 240 x 200 **TVI 1338 2430**

Anelli inclusi - Rings included
 Anneaux fournis - Ringe enthalten
 Anillas incluidas - Кольца включены





G•SCHEMA



cod. 1345
Celeste/turquoise
Light blue/turquoise
Bleu ciel/turquoise
Hellblau/türkis
Azul celeste/turquesa
Голубой/брюзовый цвет

cm. 120 x 200 **TVI 1345 1230**

cm. 180 x 200 **TVI 1345 1830**

cm. 240 x 200 **TVI 1345 2430**

Anelli inclusi - Rings included
Anneaux fournis - Ringe enthalten
Anillas incluidas - Кольца включены



G•STRÜDEL



cod. 1339
Bianco
White
Blanc
Weiss
Blanco
Белый

cm. 120 x 200 **TVI 1339 1230**

cm. 180 x 200 **TVI 1339 1830**

cm. 240 x 200 **TVI 1339 2430**

Anelli inclusi - Rings included
Anneaux fournis - Ringe enthalten
Anillas incluidas - Кольца включены





G•TABLET



cod. 1334
Azzurro
Light blue
Bleu ciel
Hellblau
Azul celeste
Голубой

cm. 120 x 200 **TVI 1334 1230**

cm. 180 x 200 **TVI 1334 1830**

cm. 240 x 200 **TVI 1334 2430**

Anelli inclusi - Rings included
Anneaux fournis - Ringe enthalten
Anillas incluidas - Кольца включены



G•TIC-TOC



cod. 1354
Bianco
White
Blanc
Weiss
Blanco
Белый

cm. 120 x 200 **TVI 1354 1230**

cm. 180 x 200 **TVI 1354 1830**

cm. 240 x 200 **TVI 1354 2430**

Anelli inclusi - Rings included
Anneaux fournis - Ringe enthalten
Anillas incluidas - Кольца включены





G•TRACCE



cod. 1337
Azzurro
Light blue
Bleu ciel
Hellblau
Azul celeste
Голубой

cm. 120 x 200 **TVI 1337 1230**

cm. 180 x 200 **TVI 1337 1830**

cm. 240 x 200 **TVI 1337 2430**

Anelli inclusi - Rings included
Anneaux fournis - Ringe enthalten
Anillas incluidas - Кольца включены



G•TROPICAL



cod. 1335
Azzurro/giallo
Light blue/yellow
Bleu ciel/jaune
Hellblau/gelb
Azul celeste/amarillo
Голубой/желтый

cm. 120 x 200 **TVI 1335 1230**

cm. 180 x 200 **TVI 1335 1830**

cm. 240 x 200 **TVI 1335 2430**

Anelli inclusi - Rings included
Anneaux fournis - Ringe enthalten
Anillas incluidas - Кольца включены



Tende doccia IGNIFUGA

Fire-proof polyester shower curtain
Rideau de douche en polyester ignifuge
Duschvorhang aus feuerhemmendem Polyester
Cortina de ducha de poliéster ignífuga
Занавеска для душа из огнестойкого полиэстера

Ignifuga - classe 1

Il tessuto ideale per alberghi e comunità.
The ideal fabric for hotels and communities.
Le tissu idéal pour hôtels et communautés.
Der ideale Stoff für Hotel und Gemeinschaften.
El material ideal para hoteles y comunidades.
Идеальная ткань для гостиниц и общественных зданий.



Pieghella 180°

Pieghella 180° SENZA TENDA
Pieghella 180° WITHOUT SHOWER CURTAIN
Pieghella 180° SANS RIDEAU
Pieghella 180° OHNE VORHANG
Pieghella 180° SIN CORTINA
Pieghella 180° БЕЗ ЗАНАВЕСКИ

Reggitenda pieghevole adatto per vasche da bagno e docce. Montaggio semplicissimo con quattro viti e tasselli a muro. Supporto e fissaggio invisibile con bracci d'acciaio.

Fold-away shower rail and curtain. Screws and wall plugs includes. Invisible fixing system with steel arms.

Cabine de douche pliable pour baignoires et douches. Montage très simple avec quatre vis. Support et fixation invisible avec bras en acier.

Duschschirm ausklappbar für Wannen und Duschen aller Grössen. Montage einfachst mit beigefügten Schrauben und Dübeln.

Varillaje para bañeras y duchas. Montaje muy fácil con 4 tornillos y tacos.

Раздвижной карниз для ванн и душевых. Максимально простой монтаж посредством четырех винтов и стеновых дюбелей. Опора и невидимый крепеж со стальными кронштейнами.



Pieghella 8 braccia
con apertura max 180°

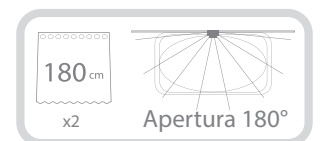
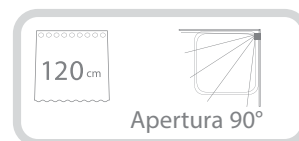

G•TINTA UNITA



cod. 6129
Bianco
White
Blanc
Weiss
Blanco
Белый

100%
made in Italy



cm. 120 x 200 **TVI 6129 6712**

cm. 180 x 200 **TVI 6129 6718**

cm. 240 x 200 **TVI 6129 6724**

Anelli inclusi - Rings included
Anneaux fournis - Ringe enthalten
Anillas incluidas - Кольца включены



TPIE 1801310

Realizzate in acciaio inox e resine termoplastiche

Made of stainless steel and thermoplastic resins

Réalisés en acier inoxydable et thermoplastique

Hergestellt aus Edelstahl und Kunststoff

Realizadas en acero inox y resinas termoplásticas

Изготовлено из нержавеющей стали и термопластичных смол

Anelli per tende doccia

Rings for shower curtains
Anneaux pour rideaux de douche
Vorhangringe
Anillas para cortinas de ducha
Кольца для занавески

TANE 100

12 pz./pcs



Realizzati in resine termoplastiche
Made of thermoplastic resins
Réalisés en thermoplastique
Hergestellt aus Kunststoff
Realizadas en resinas termoplásticas
Изготовлено из термопластичных смол

00

Trasparente
Transparent

02

Bianco
White

Supporto a soffitto per telai reggitenda - altezza regolabile

Ceiling support for shower rails-height adjustable - Support fixation plafond pour barre de douche (hauteur réglable)
Deckenhalterung für Duschstangen (höhenverstellbar) - Soporte de techo para barras de ducha (altura regulable)
Потолочная опора для штанг для занавесок (регулируемая высота)

TCAV600



Realizzato in acciaio e ottone
Made of steel and brass
Réalisé en acier et laiton
Hergestellt aus Stahl und Messing
Realizado en acero y latón
Изготовлено из стали и латуни

13

Cromato
Chromed

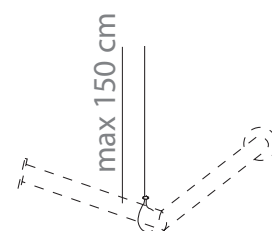

Asta doccia estensibile

Extensible shower rail
Barre de douche extensible
Teleskopduschstange
Barra extensible para cortinas
Раздвижная штанга для душа

TEST700



02 Alluminio con laccatura epossidica e resine termoplastiche
Epoxy lacquered aluminium and thermoplastic resins
Aluminium laquage époxi et thermoplastique
Aluminium mit Epoxid-Beschichtung und Kunststoff
Aluminio pintado epoxi y resinas termoplásticas
Алюминий с эпоксидным покрытием и термопластичные смолы

Bianco
White



13 Alluminio anodizzato e resine termoplastiche
Anodized aluminum and thermoplastic resins
Aluminium anodisé et thermoplastique
Eloxiertes Aluminium und Kunststoff
Aluminio anodizado y resinas termoplásticas
Анодированный алюминий и термопластичные смолы

Alluminio anodizzato
Anodized aluminum

Tenda consigliata:
Recommended shower curtain:
Rideau de douche recommandé:
Empfohlene duschvorhang:
Se recomienda cortina de ducha:
Рекомендуемая занавеска:

120 cm
180 cm

Ø 25 mm
cm 78/135

spessore/thickness
Ø 0,6 mm

TEST701



02 Alluminio con laccatura epossidica e resine termoplastiche
Epoxy lacquered aluminium and thermoplastic resins
Aluminium laquage époxi et thermoplastique
Aluminium mit Epoxid-Beschichtung und Kunststoff
Aluminio pintado epoxi y resinas termoplásticas
Алюминий с эпоксидным покрытием и термопластичные смолы

Bianco
White



13 Alluminio anodizzato e resine termoplastiche
Anodized aluminum and thermoplastic resins
Aluminium anodisé et thermoplastique
Eloxiertes Aluminium und Kunststoff
Aluminio anodizado y resinas termoplásticas
Анодированный алюминий и термопластичные смолы

Alluminio anodizzato
Anodized aluminum

Tenda consigliata:
Recommended shower curtain:
Rideau de douche recommandé:
Empfohlene duschvorhang:
Se recomienda cortina de ducha:
Рекомендуемая занавеска:

120 cm
180 cm

cm 80
Ø 25 mm
cm 87/150
spessore/thickness
Ø 0,6 mm

120 cm
180 cm

cm 93
Ø 25 mm
cm 100/163
spessore/thickness
Ø 0,6 mm

180 cm
240 cm

cm 80 cm 93
Ø 25 mm
cm 180/240
spessore/thickness
Ø 0,6 mm

Asta doccia angolare

Corner shower rail
 Barre angulaire de douche
 Eckduschstange
 Barra angular para cortinas
 Угловые карнизы для душевой занавески

TANG800



02

Bianco
White

Alluminio con laccatura epossidica e resine termoplastiche

Epoxy lacquered aluminium and thermoplastic resins
 Aluminium laquage époxi et thermoplastique
 Aluminium mit Epoxid-Beschichtung und Kunststoff
 Aluminio pintado epoxi y resinas termoplásticas
 Алюминий с эпоксидным покрытием и термопластичные смолы

13

Alluminio anodizzato
Anodized aluminium

Alluminio anodizzato e resine termoplastiche

Anodized aluminium and thermoplastic resins
 Aluminium anodisé et thermoplastique
 Eloxiertes Aluminium und Kunststoff
 Aluminio anodizado y resinas termoplásticas
 Анодированный алюминий и термопластичные смолы

Tenda consigliata:
 Recommended shower curtain:
 Rideau de douche recommandé:
 Empfohlene duschvorhang:
 Se recomienda cortina de ducha:
 Рекомендуемая занавеска:

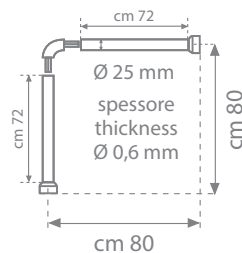

TANG801



02

Bianco
White

Alluminio con laccatura epossidica e resine termoplastiche

Epoxy lacquered aluminium and thermoplastic resins
 Aluminium laquage époxi et thermoplastique
 Aluminium mit Epoxid-Beschichtung und Kunststoff
 Aluminio pintado epoxi y resinas termoplásticas
 Алюминий с эпоксидным покрытием и термопластичные смолы

13

Alluminio anodizzato
Anodized aluminium

Alluminio anodizzato e resine termoplastiche

Anodized aluminium and thermoplastic resins
 Aluminium anodisé et thermoplastique
 Eloxiertes Aluminium und Kunststoff
 Aluminio anodizado y resinas termoplásticas
 Анодированный алюминий и термопластичные смолы

Tenda consigliata:
 Recommended shower curtain:
 Rideau de douche recommandé:
 Empfohlene duschvorhang:
 Se recomienda cortina de ducha:
 Рекомендуемая занавеска:

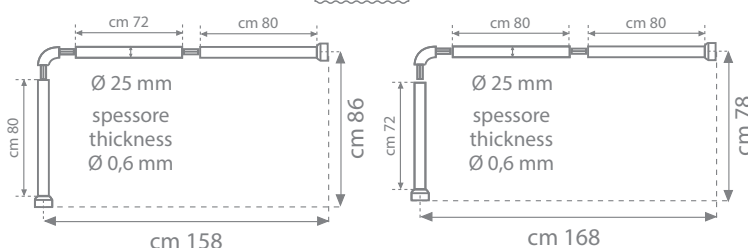

Tenda consigliata:
 Recommended shower curtain:
 Rideau de douche recommandé:
 Empfohlene duschvorhang:
 Se recomienda cortina de ducha:
 Рекомендуемая занавеска:

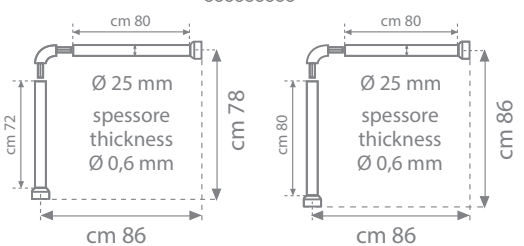

TANG802



02

Bianco
White**Alluminio con laccatura epossidica e resine termoplastiche**

Epoxy lacquered aluminium and thermoplastic resins
 Aluminium laquage époxi et thermoplastique
 Aluminium mit Epoxid-Beschichtung und Kunststoff
 Aluminio pintado epoxy y resinas termoplásticas
 Алюминий с эпоксидным покрытием и термопластичные смолы

13

Alluminio
anodizzato
Anodized
aluminum**Alluminio anodizzato e resine termoplastiche**

Anodized aluminum and thermoplastic resins
 Aluminium anodisé et thermoplastique
 Eloxiertes Aluminium und Kunststoff
 Aluminio anodizado y resinas termoplásticas
 Анодированный алюминий и термопластичные смолы

Tenda consigliata:
 Recommended
 shower curtain:
 Rideau de douche
 recommandé:
 Empfohlene
 duschvorhang:
 Se recomienda
 cortina de ducha:
 Рекомендуемая
 занавеска:

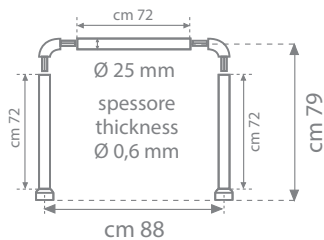

TANG803



02

Bianco
White**Alluminio con laccatura epossidica e resine termoplastiche**

Epoxy lacquered aluminium and thermoplastic resins
 Aluminium laquage époxi et thermoplastique
 Aluminium mit Epoxid-Beschichtung und Kunststoff
 Aluminio pintado epoxy y resinas termoplásticas
 Алюминий с эпоксидным покрытием и термопластичные смолы

13

Alluminio
anodizzato
Anodized
aluminum**Alluminio anodizzato e resine termoplastiche**

Anodized aluminum and thermoplastic resins
 Aluminium anodisé et thermoplastique
 Eloxiertes Aluminium und Kunststoff
 Aluminio anodizado y resinas termoplásticas
 Анодированный алюминий и термопластичные смолы

Tenda consigliata:
 Recommended
 shower curtain:
 Rideau de douche
 recommandé:
 Empfohlene
 duschvorhang:
 Se recomienda
 cortina de ducha:
 Рекомендуемая
 занавеска:

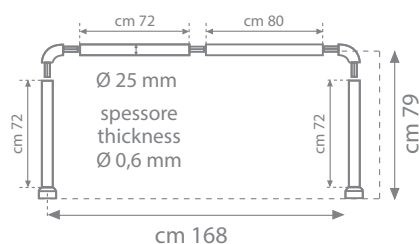
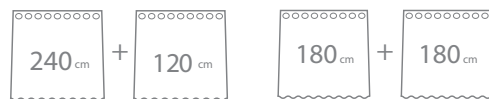

TUNI900



02

Bianco
White**Alluminio con laccatura epossidica e resine termoplastiche**

Epoxy lacquered aluminium and thermoplastic resins
Aluminium laquage époxi et thermoplastique
Aluminium mit Epoxid-Beschichtung und Kunststoff
Aluminio pintado epoxi y resinas termoplásticas
Алюминий с эпоксидным покрытием и термопластичные смолы



13

Alluminio
anodizzato
Anodized
aluminum**Alluminio anodizzato e resine termoplastiche**

Anodized aluminum and thermoplastic resins
Aluminium anodisé et thermoplastique
Eloxiertes Aluminium und Kunststoff
Aluminio anodizado y resinas termoplásticas
Анодированный алюминий и термопластичные смолы



Tenda consigliata:
Recommended shower curtain:
Rideau de douche recommandé:
Empfohlene duschvorhang:
Se recomienda cortina de ducha:
Рекомендуемая занавеска:

180 cm

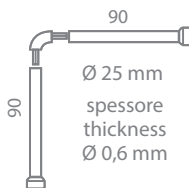

Tenda consigliata:
Recommended shower curtain:
Rideau de douche recommandé:
Empfohlene duschvorhang:
Se recomienda cortina de ducha:
Рекомендуемая занавеска:

240 cm



Tenda consigliata:
Recommended shower curtain:
Rideau de douche recommandé:
Empfohlene duschvorhang:
Se recomienda cortina de ducha:
Рекомендуемая занавеска:

240 cm

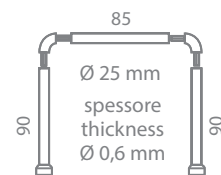

SENSORIAL



Tappeti in cotone

Cotton mats - Tapis en coton - Matten aus Baumwolle
Alfombras de algodón - Хлопок



G•BOMBAY

BO 5080

80 cm



50 cm

TRATTAMENTO ANTISCIVOLO SPRAY LATEX

ANTISLIP SPRAY LATEX BACKING

ENVERS ANTIGLISSANT

LATEXÉ SPRAY

MIT GLEITSCHUTZENDER SPRAY

LATEXBESCHICHTUNG

CON RECUBRIMIENTO DE LATEX SPRAY CONTRA RESBALÓN

С ЗАВОЛАКИВАНИЕМ СПРАЙ



04

Verde
Green
Vert
Grün
Verde
Зелёный

11

Azzurro
Light blue
Bleu ciel
Hellblau
Azul celeste
Голубой

67

Arancio
Orange
Anaranjado
Оранжевый



1400 gr/mq



G•BRAMANTE

96 6860

100 cm

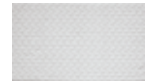

60 cm

TRATTAMENTO ANTISCIVOLO SPRAY LATEX

ANTISLIP SPRAY LATEX BACKING

ENVERS ANTIGLISSANT

LATEXÉ SPRAY

MIT GLEITSCHUTZENDER SPRAY

LATEXBESCHICHTUNG

CON RECUBRIMIENTO DE LATEX SPRAY CONTRA RESBALÓN

С ЗАВОЛАКИВАНИЕМ СПРАЙ

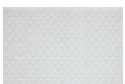

02

Bianco
White
Blanc
Weiss
Blanco
Белый

03

Ecrü
Ekrü
Беж



1440 gr/mq



G•DELHI

DE 5080

81 cm



REVERSIBILE

REVERSIBLE - RÉVERSIBLE

WENDE-DESIGN - REVERSIBLE - РЕВЕРЗИБЕЛЬНО



03

Ecru
Ecru
Ecru
Ekrü
Ecru
Темно

36

Nocciola
Hazelnut
Noisette
Haselnussbraun
Avellana
Фундука цвет



G•KLIMT

96 7340

96 7350

96 7360

60 cm



80 cm



100 cm



FONDO IN LATEX

LATEX BACKING - ENVERS LATEXÉ

LATEXBESCHICHTUNG - RECUBRIMIENTO DE LÁTEX

С ЛАТЕКОВЫМ НИЖНИМ СЛОЕМ

LATEX BACKING - ENVERS LATEXÉ

LATEXBESCHICHTUNG - RECUBRIMIENTO DE LÁTEX

С ЛАТЕКОВЫМ НИЖНИМ СЛОЕМ



03

Ecru
Ekrü
Беж

05

Blu
Blue
Bleu
Blau
Azulón
Синий

08

Grigio
Grey
Gris
Grau
Gris
Серый

29

Moka
Moka



G•MANTEGNA

94 0170
120 cm



TRATTAMENTO ANTISCIVOLO SPRAY LATEX
ANTISLIP SPRAY LATEX BACKING - ENVERS ANTIGLISSANT
LATEXÉ SPRAY - MIT GLEITSCHUTZENDER SPRAY
LATEXBESCHICHTUNG
CON RECUBRIMIENTO DE LATEX SPRAY CONTRA RESBALÓN
С ЗАВОЛАКИВАНИЕМ СПРАЙ

57% poliestere - polyester - polyester - Polyester - poliester - полиэстер
 43% cotone - cotton - coton - Baumwolle - algodón - хлопок



87
Oro
Gold
Or
Золото



G•TINTORETTO

96 7240 96 7250 96 7260

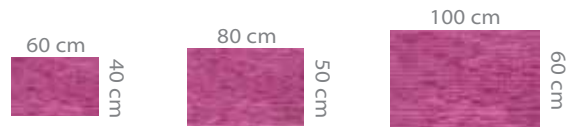

FONDO IN LATEX
LATEX BACKING - ENVERS LATEXÉ - LATEXBESCHICHTUNG
RECUBRIMIENTO DE LÁTEX - С ЛАТЕКСОВЫМ НИЖНИМ СЛОЕМ
LATEX BACKING - ENVERS LATEXÉ
LATEXBESCHICHTUNG - RECUBRIMIENTO DE LÁTEX
С ЛАТЕКСОВЫМ НИЖНИМ СЛОЕМ

25% poliestere - polyester - polyester - Polyester - poliester - полиэстер
 75% cotone - cotton - coton - Baumwolle - algodón - хлопок



67
Arancio
Orange
Anaranjado
Оранжевый



76
Fucsia
Fuchsia
Fuchsia
Fucsia
Фуксия



G•TIZIANO

96 6550 96 6560 96 6570

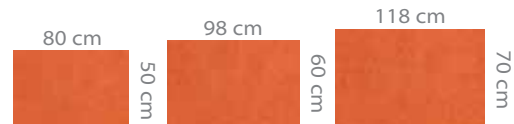

TRATTAMENTO ANTISCIVOLO SPRAY LATEX
 ANTISLIP SPRAY LATEX BACKING - ENVERS ANTIGLISSANT
 LATEXÉ SPRAY - MIT GLEITSCHUTZENDER SPRAY
 LATEXBESCHICHTUNG
 CON RECUBRIMIENTO DE LATEX SPRAY CONTRA RESBALÓN
 С ЗАВОЛАКИВАНИЕМ СПРАЙ



06
 Rosso
 Red
 Rouge
 Rot
 Rojo
 Красный

29
 Moka
 Moka

67
 Arancio
 Orange
 Anaranjado
 Оранжевый

Escluso/
 Without 966570



G•UDAIPUR

UD 5080



TRATTAMENTO ANTISCIVOLO SPRAY LATEX
 ANTISLIP SPRAY LATEX BACKING
 ENVERS ANTIGLISSANT
 LATEXÉ SPRAY - MIT GLEITSCHUTZENDER SPRAY
 LATEXBESCHICHTUNG
 CON RECUBRIMIENTO DE LATEX SPRAY CONTRA RESBALÓN
 С ЗАВОЛАКИВАНИЕМ СПРАЙ



49
 Bianco/Fucsia/Lilla
 White/Fuchsia/Lilac
 Blanc/Fuchsia/Lilas
 Weiss/Fuchsia/Fieder
 Blanco/Fucsia/Lila
 Белый/Фуксия/
 Сирень



89
 Bianco/Blu/Verde
 White/Blue/Green
 Blanc/Bleu/Vert
 Weiss/Blau/Grün
 Blanco/Azulón/Verde
 Белый/Голубой/Зелёный



93
 Bianco/Arancio/Rosso
 White/Orange/Red
 Blanc/Orange/Rouge
 Weiss/Orange/Rot
 Blanco/Aranjado/Rojo
 Белый/Оранжевый/
 Красный

Tappeti in microfibra

Microfiber mats - Tapis en microfibre - Matten aus Mikrofaser
Alfombras de microfibra - Ковры из микрофибры



G•DONATELLO

94 0240

94 0250

94 0260

60 cm



40 cm

80 cm



50 cm

100 cm



60 cm

FONDO IN LATEX

LATEX BACKING - ENVERS LATEXÉ - LATEXBESCHICHTUNG
RECUBRIMIENTO DE LÁTEX - С ЛАТЕКСОВЫМ НИЖНИМ СЛОЕМ

100% poliester - polyester - polyester - Polyester - poliester - полиэстер



08
Grigio
Grey
Gris
Grau
Gris
Серый

Abbi cura del tuo corpo,
è l'unico posto in cui devi vivere.

Take care of your body.
It's the only place you have to live.





Indice HYDROTHERAPY

hand shower	pagina 484
shower kit	pagina 499
shower set	pagina 508
shower column	pagina 521
shower panel	pagina 532
shower head	pagina 544
flex	pagina 548
accessories	pagina 551
hydraulics	pagina 561

HYDROTHERAPY

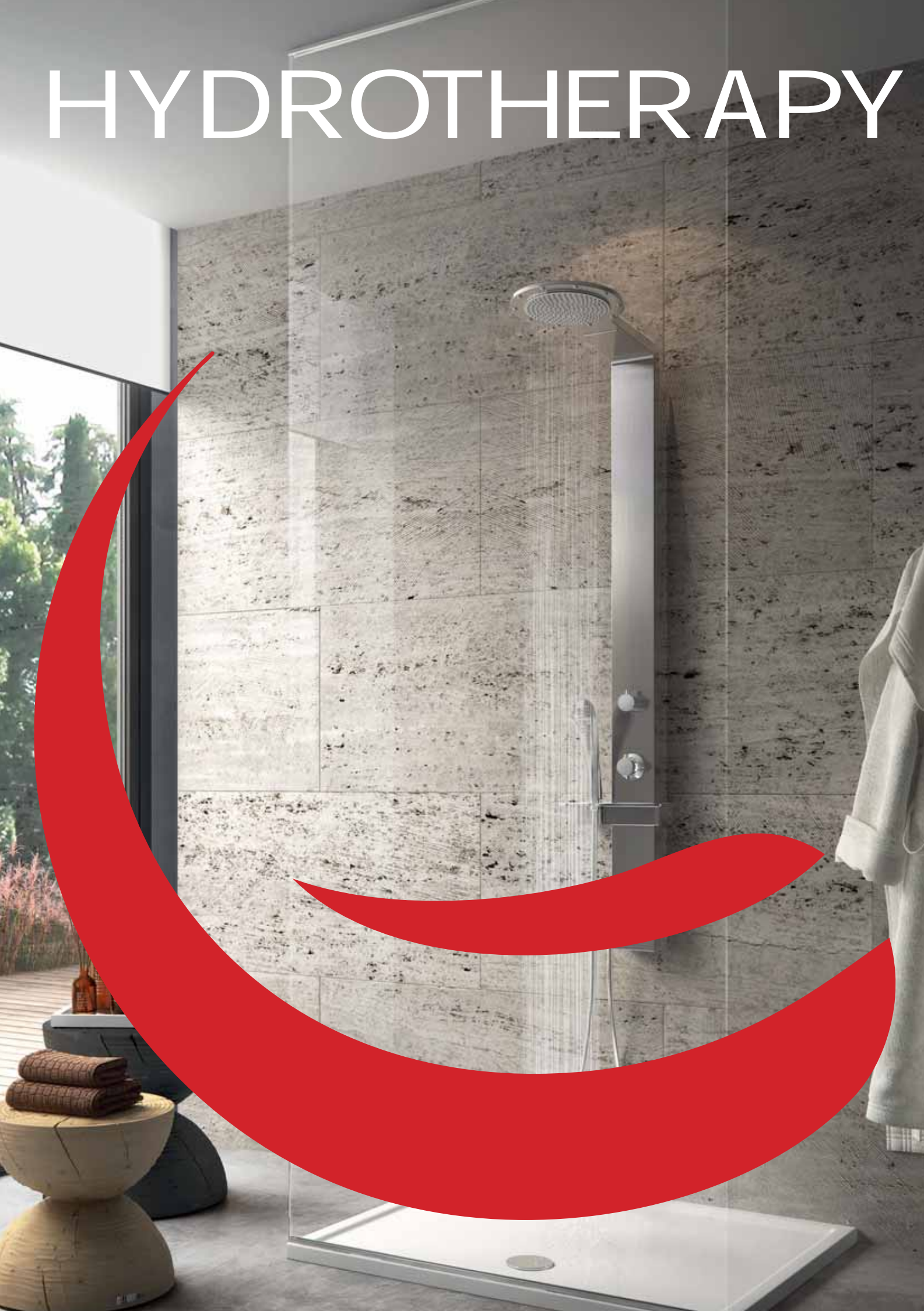

G•HAND SHOWER

Le doccette Gedy sono presentate in una gamma ampia per design, numero di funzioni e prezzo.

Sono tutte dotate di filtro antisabbia, tettarelle che permettono una facile rimozione del calcare accumulatosi e di un filtro che permette la riduzione fino al 50% del consumo di acqua. Tutti gli attacchi sono nella misura universale standard 1/2".

Les douchettes Gedy sont présentées dans une vaste gamme subdivisée suivant le design, le nombre de fonctions et le prix. Elles sont toutes munies d'un filtre anti-sable, de pièces qui facilitent l'élimination du calcaire et d'un filtre qui permet de réduire jusqu'à 50% la consommation d'eau. Tous les raccords sont fournis dans la dimension universelle standard de 1/2 pouces.

Los mangos de ducha Gedy están disponibles en una amplia gama de modelos distintos por diseño, número de funciones y precio. Todos están dotados de filtro antiarena, eyectores que permiten una fácil remoción de la cal acumulada y de un filtro que permite reducir hasta el 50% el consumo de agua. Todas las conexiones son de tipo universal estándar de 1/2".

Gedy shower heads are available in a wide range of designs, function and prices.

All have sand filter, nipples for easy scale removal, and a filter to cut water consumption by up to 50%. All attachments are in the universal standard size of 1/2".

Die Handduschen Gedy werden hinsichtlich Design, Anzahl der Funktionen und Preis in einer großen Palette präsentiert. Alle ausgestattet mit Sandfilter, Einsatz für eine einfache Entfernung von Kalkablagerungen sowie Filter für die Verringerung des Wasserverbrauch um bis zu 50 %. Alle Anschlüsse mit den Standard-Universalmaßen 1/2".

Ручные души Gedy представлены в широком ассортименте по дизайну, количеству функций и стоимости. Все они оснащены фильтром для задержки песка, легко чистящимися от скопившейся накипи соплами и регулятором расхода, позволяющим сэкономить до 50% воды. Все соединения универсальные, отвечающие стандарту 1/2".

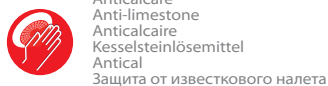

Connessione
UNIVERSALE
Universal
CONNECTION

col. 13

Cromato
Chromed
Chromé
Chrom
Cromado
Хром

Realizzate in ABS
Made of ABS
Réalisés en ABS
Hergestellt aus ABS
Realizados en ABS
Изготовлено из АБС пластик

G•BASIC



G•BASIC 00

GYHS09000

Ø 6,7 x 6 x 20 cm

BIANCO/WHITE



G•BASIC 01

GYHS09001

Ø 6,7 x 6 x 20 cm

CROMATO/CHROMED



G•EASY

G•EASY 00

GYHS10000

Ø 6 x 5 x 18 cm

CROMATO/CHROMED



G•EASY 02

GYHS10002

Ø 6,7 x 6 x 20 cm

CROMATO/CHROMED



G•EASY 03

GYHS10003

Ø 6,7 x 6 x 20 cm

BIANCO/WHITE



G•EASY

G•EASY O4

GYHS10004

Ø 6,7 x 6 x 20 cm

NERO/BLACK



RAIN

G•EASY O5

GYHS10005

Ø 7,6 x 5 x 20 cm

CROMATO/CHROMED



RAIN

G•EASY O6

GYHS10006

Ø 8,4 x 6,5 x 19,5 cm

CROMATO/CHROMED



RAIN



SOFT



TONIC



RAIN+SOFT

G•HAND SHOWER

G•TRENDY

G•TRENDY O0

GYHS10100

Ø 3 x 21 cm

CROMATO/CHROMED



G•TRENDY O1

GYHS10101

Ø 6,5 x 5 x 21,5 cm

CROMATO/CHROMED



G•TRENDY O2

GYHS10102

Ø 4,3 x 3,9 x 22,8 cm

CROMATO/CHROMED



G•TRENDY O3

GYHS10103

Ø 6,8 x 9,3 x 23 cm

CROMATO/CHROMED



G•STAR

G•STAR 00

GYHS10200

Ø 8 x 5 x 22 cm

CROMATO/CHROMED



G•STAR 01

GYHS10201

Ø 8 x 5 x 22 cm

CROMATO/CHROMED



G•STAR 04

GYHS10204

Ø 10 x 3 x 24,5 cm

CROMATO/CHROMED



G•STAR 05

GGYHS10205

Ø 10 x 3 x 24,5 cm

CROMATO/CHROMED



G•HAND SHOWER

G•TECH

G•TECH 00

GYHS10300

Ø 12 x 4 x 25 cm

CROMATO/CHROMED



RAIN

G•TECH 01

GYHS10301

Ø 12 x 4 x 25 cm

CROMATO/BIANCO
CHROMED/WHITE



RAIN



TONIC



RAIN+TONIC

G•TECH 02

GYHS10302

Ø 12 x 4 x 25 cm

CROMATO/CHROMED



RAIN



TONIC



RAIN+TONIC

G•TECH 03

GYHS10303

Ø 12 x 4 x 25 cm

NICHEL SPAZZOLATO
BRUSHED NICKEL



RAIN



TONIC



RAIN+TONIC

G•TECH 04

GYHS10304

Ø 11,5 x 6 x 25 cm

CROMATO/CHROMED



RAIN

G•TECH 05

GYHS10305

Ø 11,5 x 6 x 25 cm

CROMATO/CHROMED



RAIN



TONIC



RAIN+TONIC

G•TECH

G•TECH 06

GYHS10306

Ø 11,5 x 6 x 25 cm

CROMATO/CHROMED



5
JETS



RAIN



TONIC



MASSAGE



RAIN+TONIC



RAIN+MASSAGE

G•TECH 07

GYHS10307

Ø 12 x 3,5 x 25,5 cm

CROMATO/CHROMED



3
JETS



RAIN



TONIC



RAIN+TONIC

G•TECH 08

GYHS10308

Ø 10,5 x 5, x 24,5 cm

CROMATO/CHROMED



3
JETS



RAIN



CASCADE



AQUA STOP

G•TECH 10

GYHS10310

Ø 8 x 5 x 27 cm

CROMATO/CHROMED



3
JETS



RAIN



MASSAGE



RAIN+MASSAGE

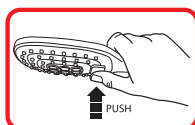

PUSH SYSTEM JETS CHANGE
CAMBIO GETTI A PULSANTE

G•TECH 11

GYHS10311

Ø 12 x 3,5 x 26,5 cm

CROMATO/CHROMED



3
JETS



RAIN



MASSAGE



RAIN+MASSAGE

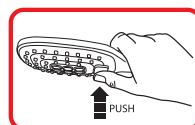

PUSH SYSTEM JETS CHANGE
CAMBIO GETTI A PULSANTE

G•TECH 12

GYHS10312

Ø 12 x 4 x 25 cm

CROMATO/CHROMED



3
JETS



RAIN



TONIC



RAIN+TONIC

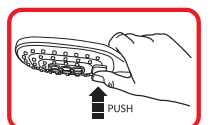

PUSH SYSTEM JETS CHANGE
CAMBIO GETTI A PULSANTE

G•HAND SHOWER



G•TOP

G•TOP 00

GYHS10400

Ø 12 x 6 x 26 cm

CROMATO/CHROMED



RAIN



TONIC



MASSAGE



RAIN+TONIC



RAIN+MASSAGE

G•TOP 01

GYHS10401

Ø 15 x 5,5 x 29 cm

CROMATO/CHROMED



RAIN



TONIC



SOFT



CASCADE



AQUA STOP

G•HAND SHOWER

G•TENDENCE

G•TENDENCE 00

GYHS10500

Ø 13,5 x 3 x 26,5 cm

CROMATO/BIANCO
CHROMED/WHITE

RAIN



MASSAGE

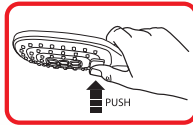

RAIN+MASSAGE

PUSH SYSTEM JETS CHANGE
CAMBIO GETTI A PULSANTE

G•TENDENCE 01

GYHS10501

Ø 13,5 x 3 x 26,5 cm

CROMATO/NERO
CHROMED/BLACK

RAIN



MASSAGE

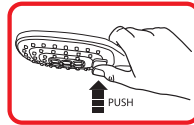

RAIN+MASSAGE

PUSH SYSTEM JETS CHANGE
CAMBIO GETTI A PULSANTE

G•TENDENCE 02

GYHS10502

Ø 6 x 4 x 25 cm

CROMATO/BIANCO
CHROMED/WHITE

RAIN

G•TENDENCE 03

GYHS10503

Ø 6 x 4 x 25 cm

CROMATO/NERO
CHROMED/BLACK

RAIN

G•TENDENCE 06

GYHS10506

Ø 10,5 x 3 x 25,5 cm

BIANCO/WHITE



RAIN

G•TENDENCE 07

GYHS10507

Ø 10,5 x 3 x 25,5 cm

NERO /BLACK



RAIN

G•TENDENCE

G•TENDENCE 08

GYHS10508

Ø 10 x 4 x 26 cm

CROMATO/BIANCO
CHROMED/WHITE

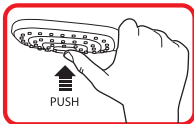

ANTH-LIMESTONE PUSH SYSTEM
PULIZIA CALCARE A PULSANTE

G•TENDENCE 10

GYHS10510

Ø 10 x 4 x 26 cm

CROMATO/BIANCO
CHROMED/WHITE

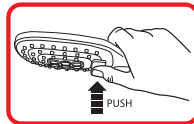

PUSH SYSTEM JETS CHANGE
CAMBIO GETTI A PULSANTE

G•HAND SHOWER

G•LIBERTY

G•LIBERTY O0

GYHS10600

Ø 9 x 8,7 x 24 cm

CROMATO/CHROMED



G•LIBERTY O1

GYHS10601

Ø 9 x 8,7 x 24 cm

BRONZO/BRONZE



G•LIBERTY O2

GYHS10602

Ø 9 x 8,7 x 24 cm

RAME/ COPPER



G•LIGHT - THERMO LIGHT - THERMO

G•LIGHT O0

GYHS10700
 Ø 10 x 6,4 x 25 cm
 CROMATO/CHROMED



3
 JETS



RAIN



TONIC



RAIN+TONIC



COLOR CHANGE

G•LIGHT O1

GYHS10701
 Ø 10 x 6,4 x 25 cm
 BIANCO/WHITE



3
 JETS



RAIN



TONIC



RAIN+TONIC



COLOR CHANGE

G•LIGHT O3

GYHS10703
 Ø 10,9 x 7,9 x 24,2 cm
 CROMATO/CHROMED



1
 JET



RAIN



COLOR CHANGE

G•LIGHT O6

GYHS10706
 Ø 11,3 x 10,5 x 25 cm
 CROMATO/CHROMED



3
 JETS



RAIN



TONIC



RAIN+TONIC



COLOR CHANGE

G•LIGHT O9

GYHS10709
 Ø 11,3 x 10,5 x 25 cm
 CROMATO/CHROMED



3
 JETS



RAIN



TONIC



RAIN+TONIC

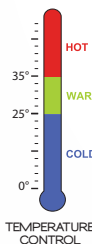

COLOR CHANGE

G•THERMO LIGHT O0

GYHS10800
 Ø 12,1 x 4,3 x 24 cm
 CROMATO/CHROMED



1
 JET



RAIN



TEMPERATURE CHECK POINT

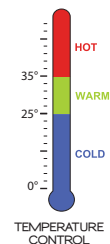

COLOR CHANGE

G•HAND SHOWER



G•LIGHT - THERMO LIGHT - THERMO

G•THERMO LIGHT O1

GYHS10801
 Ø 12,1 x 4,3 x 24 cm
 BIANCO/WHITE

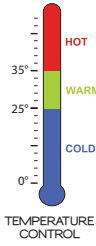

G•THERMO OO

GYHS10900
 Ø 11,9 x 6,2 x 26 cm
 CROMATO/CHROMED



G•MUSIC OO

GYHS11100
 Ø 12,5 x 4 x 25 cm
 CROMATO/BIANCO
 CHROMED/WHITE



G•THERMO LIGHT O2

GYHS10802
 Ø 12,1 x 4,3 x 24 cm
 NERO/BLACK

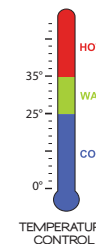

G•THERMO O1

GYHS10901
 Ø 11,9 x 6,2 x 26 cm
 BIANCO/WHITE



G•SHOWER KIT

Alcune doccette della nostra gamma vengono presentate in una pratica confezione per il consumatore che include un flessibile in acciaio inox da cm.150 e un supporto a parete.

Certaines douchettes de notre gamme sont présentées dans un emballage pratique pour le consommateur, avec un tuyau flexible en acier inox de 150 cm et un support mural.

Igunos mangos de ducha de nuestra gama están contenidos dentro de una caja muy práctica para el consumidor que incluye un flexo de acero inoxidable de 150 cm y un soporte de pared.

Some shower heads in our range are sold in a practical package for the customer, which includes a 150 cm stainless steel hose plus a wall bracket.

Einige Handduschen unserer Produktpalette werden in einer praktischen Konfektion für den Verbraucher präsentiert, die einen Schlauch aus Edelstahl zu 150 cm sowie eine Wandhalterung umfasst.

Некоторые ручные души нашей коллекции представлены в виде практично упакованных комплектов, включающих шланг из нержавеющей стали на 150 см. и настенное крепление.

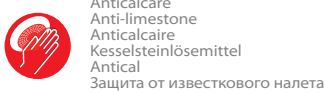

ConneSSIONE
UNIVERSALE
Universal
CONNECTION

col. 13
Cromato
Chromed
Chromé
Cromado
Хром

Realizzati in ABS, acciaio inox e ottone
Made of ABS, stainless steel and brass
Réalisés en ABS, acier inoxydable and laiton
Hergestellt aus ABS, Edelstahl und Messing
Realizados en ABS, acero inox y latón
Изготовлено из АБС,
нержавеющей стали и латуны

G•EASY



G•EASY O0

GYSK10000

CROMATO/CHROMED



1
JET



G•EASY O2

GYSK10002

CROMATO/CHROMED



1
JET



G•EASY O5

GYSK10005

CROMATO/CHROMED



1
JET



G•EASY O6

GYSK10006

CROMATO/CHROMED



4
JETS



G•SHOWER KIT

G•TRENDY

G•TRENDY O0

GYSK10100

CROMATO/CHROMED



G•TRENDY O1

GYSK10101

CROMATO/CHROMED



G•TRENDY O2

GYSK10102

CROMATO/CHROMED



G•TRENDY O3

GYSK10103

CROMATO/CHROMED



G•STAR

G•STAR O0

GYSK10200

CROMATO/CHROMED



G•STAR O1

GYSK10201

CROMATO/CHROMED



G•STAR O4

GYSK10204

CROMATO/CHROMED



G•STAR O5

GYSK10205

CROMATO/CHROMED



G•SHOWER KIT



G•TECH

G•TECH 00

GYSK10300

CROMATO/CHROMED



1
JET



G•TECH 02

GYSK10302

CROMATO/CHROMED



3
JETS



G•TECH 03

GYSK10303

NICHEL SPAZZOLATO
BRUSHED NICKEL



3
JETS



G•TECH 05

GYSK10305

CROMATO/CHROMED



3
JETS



G•TECH 06

GYSK10306

CROMATO/CHROMED



5
JETS



G•TECH 08

GYSK10308

CROMATO/CHROMED



3
JETS



G•TENDENCE

G•TENDENCE O2

GYSK10502

CROMATO/BIANCO
CHROMED/WHITE



RAIN

G•TENDENCE O3

GYSK10503

CROMATO/NERO
CHROMED/BLACK



RAIN

G•TENDENCE O6

GYSK10506

BIANCO/WHITE



RAIN

G•TENDENCE O7

GYSK10507

NERO/BLACK



RAIN

G•SHOWER KIT

G•LIBERTY

G•LIBERTY O0 G•LIBERTY O1 G•LIBERTY O2

GYSK10600

GYSK10601

GYSK10602

CROMATO/CHROMED

BRONZO/BRONZE

RAME/ COPPER



G•SPEEDY

G•MUSIC

G•SPEEDY

G•MUSIC O0

GYSK99000

GYSK11100

CROMATO/CHROMED

CROMATO-BIANCO/
WHITE-CHROMED



G•SHOWER SET

A completamento della gamma doccette, Gedy propone anche la versione saliscendi, anche con interasse variabile del supporto a muro in modo da coprire fori a parete preesistenti, completa di flessibile in acciaio inox da cm.150 e di un porta sapone/porta oggetti. Disponibili anche una versione senza portasapone e la sola barra con saliscendi di ricambio.

Pour compléter la gamme des douchettes, Gedy propose également la version avec une barre de douche, munie d'un entraxe variable du support mural de manière à couvrir les trous préexistants dans le mur, et un tuyau flexible en acier inox de 150 cm et un porte-savon/porte-objets. On propose également une version sans porte-savon, comprenant uniquement la barre avec un dispositif de coulissement de rechange.

Para completar la gama de mangos de ducha, Gedy propone también la versión con soporte deslizante, también con distancia entre ejes variable del soporte de pared para tapar los agujeros ya existentes en la pared, completa de flexo de acero inoxidable de 150 cm y de una jabonera/porta-objetos. Disponible también una versión sin jabonera y solo la barra con soporte deslizante de repuesto.

To complete the range of shower heads, Gedy also offers the sliding bar version, with a variable fastening distance so as to cover existing holes in the wall and complete with 150 cm flexible hose and a soap/object dish. Also available without soap dish and with spare sliding bar.

Zur Vervollständigung der Handduschenpalette bietet Gedy auch die Version mit Wandschiene an, auch mit variablem Abstand der Wandhalterung zur Abdeckung der in der Wand vorhandenen Bohrungen, vollständig mit Schlauch aus Edelstahl zu 150 cm und Seifenhalter/Ablage. Auch verfügbar in einer Version ohne Seifenhalter und nur Ersatz-Wandschiene.

Для дополнения коллекции душей компания Gedy предлагает также исполнение со штангой, в том числе с подвижным настенным креплением, позволяющим скрыть существующие на стене отверстия, в комплекте со шлангом из нержавеющей стали на 150 см. и мыльницей/полочкой. Возможен вариант штанги со сменными держателями без мыльницы.

 Filtro Antisabbia
Sand filter
Filtre anti-sable
Sandschutzfilter
Filtro antirena
Универсальное крепление

 Pioggia
Rain
Pluie
Regen
Lluvia
Дождик

 Morbido
Soft
Moelleux
Weich
Suave
Мягкая

 Cascata
Cascade
Cascade
Wasserfall
Cascada
Водопад

 Sottile
Thin
Fin
Leicht
Fino
Тонкая

 Doppio relax
Double relax
Double détente
Doppleter Relax
Doble Relax
Супер релакс

 Nebulizzato
Spray
Nébulisé
Zerstäubt
Nebulizado
Распыление

 Acqua stop
Water stop
Arrêt eau
Wasserstopp
Agua stop
Пульсация

Connessione
UNIVERSALE
Universal
CONNECTION

col. 13
Cromato
Chromed
Chromé
Chrom
Хром

Realizzati in ABS e acciaio inox
Made of ABS and stainless steel
Réalisés en ABS et acier inoxydable
Hergestellt aus ABS und Edelstahl
Realizados en ABS y acero inox
Изготовлено из АБС
и нержавеющей сталь



G•EASY

G•EASY O2

GYSS10002

LUCIDO/POLISHED



G•EASY O5

GYSS10005

LUCIDO/POLISHED



G•EASY O6

GYSS10006

LUCIDO/POLISHED



G•TRENDY

G•TRENDY O0

GYSS10100

LUCIDO/POLISHED



G•TRENDY O1

GYSS10101

LUCIDO/POLISHED



G•TRENDY O2

GYSS10102

CROMATO/CHROMED



G•TRENDY O3

GYSS10103

CROMATO - CHROMED



G•STAR

G•STAR O1

GYSS10201

CROMATO/CHROMED



RAIN



TONIC

G•STAR O4

GYSS10204

CROMATO/CHROMED



RAIN

G•STAR O5

GYSS10205

CROMATO/CHROMED



RAIN



TONIC



RAIN+TONIC

G•SHOWER SET



G•TECH O0 **G•TECH O1** **G•TECH O2**

GYSS10300

GYSS10301

GYSS10302

CROMATO/CHROMED

CROMATO/BIANCO
CHROMED/WHITE

CROMATO/CHROMED



RAIN



RAIN



TONIC



RAIN+TONIC



RAIN



TONIC



RAIN+TONIC

G•TECH

G•TECH 03

GYSS10303

NICHEL SPAZZOLATO
BRUSHED NICKEL



3
JETS



RAIN



TONIC



RAIN+TONIC

G•TECH 05

GYSS10305

CROMATO/CHROMED



3
JETS



RAIN



TONIC



RAIN+TONIC

G•TECH 06

GYSS10306

CROMATO/CHROMED



5
JETS



RAIN



TONIC



MASSAGE



RAIN+TONIC



RAIN+MASSAGE

G•SHOWER SET

G•TECH 08

GYSS10308

CROMATO/CHROMED



RAIN



CASCADE



AQUA STOP

G•TECH 10

GYSS10310

CROMATO/CHROMED



RAIN



MASSAGE



RAIN+MASSAGE

G•TECH 11

GYSS10311

CROMATO/CHROMED



RAIN



MASSAGE



RAIN+MASSAGE

G•TOP

G•TOP 00

GYSS10400

CROMATO/CHROMED



5
JETS



RAIN



TONIC



MASSAGE



RAIN+TONIC



RAIN+MASSAGE

G•TOP 01

GYSS10401

CROMATO/CHROMED



5
JETS



RAIN



TONIC



SOFT



CASCADE



AQUA STOP

G•SHOWER SET

G•TENDENCE

G•TENDENCE 00

GYSS10500

CROMATO/BIANCO
CHROMED/WHITE



RAIN



MASSAGE



RAIN+MASSAGE



G•TENDENCE 01

GYSS10501

CROMATO/NERO
CHROMED/BLACK



RAIN



MASSAGE



RAIN+MASSAGE



G•TENDENCE

G•TENDENCE O2

GYSS10502

CROMATO/BIANCO
CHROMED/WHITE



G•TENDENCE O3

GYSS10503

CROMATO/NERO
CHROMED/BLACK



G•SHOWER SET

G•TENDENCE O6

GYSS10506

CROMATO/BIANCO
CHROMED/WHITE



G•TENDENCE O7

GYSS10507

CROMATO/NERO
CHROMED/BLACK



G•LIBERTY

G•LIBERTY 00

GYSS10600

CROMATO/CHROMED



G•LIBERTY 01

GYSS10601

BRONZO/BRONZE



G•LIBERTY 02

GYSS10602

RAME/COPPER



G•SHOWER COLUMN

Una gamma compatta che va incontro a tutti i gusti e alle funzioni richieste nella doccia, racchiuse in un solo articolo compatto e dalle giuste proporzioni. Tutte le colonne sono regolabili in altezza per il massimo confort nella doccia per tutti i membri della famiglia.

Une gamme compacte qui satisfait tous les goûts et les fonctions d'une douche, réunies en un seul article compact et bien proportionné. Toutes les colonnes sont réglables en hauteur assurant le plus grand confort à l'intérieur de la douche à tous les membres de la famille.

Una gama compacta que satisface todos los gustos y las funciones requeridas para la ducha, unidas en un sólo artículo compacto y de proporciones adecuadas. Todas las barras para la ducha son regulables en altura para el máximo confort en la ducha de todos los miembros de la familia.

A compact range to satisfy all tastes and all of the functions required of a shower, in a single, compact and perfectly sized item. All columns are height adjustable for maximum shower comfort for all members of the family.

Eine kompakte, trendige Produktpalette, die alle Funktionen einer Dusche erfüllt, und dies in einem einzigen kompakten Artikel mit den richtigen Proportionen. Alle Duschsäulen sind höhenverstellbar, um allen Mitgliedern der Familie in der Dusche den optimalen Komfort zu bieten.

Эта компактная линейка душей отвечает всем требованиям и вкусам, объединенными в одном предмете оптимальных размеров.

Все души-колонны регулируются по высоте, что обеспечивает максимальный комфорт в душе для всех членов семьи.



Filtro Antisabbia
Sand filter
Filtre anti-sable
Sandschutzfilter
Filtro antirena
Универсальное крепление



Anticalcare
Anti-limestone
Anticalcaire
Kesselsteinlösemittel
Antical
Защита от известкового налета



Pioggia
Rain
Pluie
Regen
Lluvia
Дождик



Sottile
Thin
Fin
Leicht
Fino
Тонкая



Doppio relax
Double relax
Double détente
Doppleter Relax
Doble Relax
Супер релакс

Conessione
UNIVERSALE
Universal
CONNECTION

Realizzati in acciaio inox e ABS
Made of stainless steel and ABS
Réalisés en acier inoxydable et ABS
Hergestellt aus Edelstahl und ABS
Realizados en acero inox y ABS
Изготовлено из нержавеющей стали и ABS

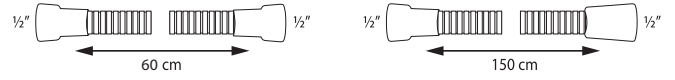

G•EASY



G•EASY 00

GYSC10000
20 x 41 x 100 cm
CROMATO/CHROMED



G•EASY 01

GYSC10001
23 x 46 x 100 cm
CROMATO/BIANCO
CHROMED/WHITE



G•EASY O2

GYSC10002

20 x 39 x 104 cm

CROMATO/CHROMED



1
JET



RAIN

5
JETS



RAIN



TONIC



SOFT



RAIN+TONIC



RAIN+SOFT

G•EASY O3

GYSC10003

20 x 44,5 x 100 cm

CROMATO/CHROMED



1
JET



RAIN

1
JET



RAIN



G•SHOWER COLUMN

G•EASY

G•EASY O4

GYSC10004

23 x 46 x 100 cm

CROMATO/CHROMED



G•EASY MIX O1

GYSC10101

20 x 39 x 100 cm

CROMATO/CHROMED



G•EASY

G•EASY MIX O2

GYSC10102

23 x 46 x 100 cm

CROMATO/CHROMED



RAIN



RAIN



TONIC



RAIN+TONIC

G•SHOWER COLUMN

G•STAR

G•STAR 00

GYSC10200

28 x 52 x 80/120 cm

CROMATO/CHROMED



RAIN



RAIN

G•STAR 01

GYSC10201

20 x 49 x 106 cm

CROMATO/CHROMED



RAIN



RAIN

G•STAR

G•STAR MIX OO

GYSC10300
28 x 52 x 80/120 cm
CROMATO/CHROMED



G•STAR MIX O1

GYSC10301
26 x 54,5 x 98,5/133,5 cm
CROMATO/CHROMED



G•SHOWER COLUMN

G•LIBERTY

G•LIBERTY 00

GYSC10600

20 x 43 x 105 cm

CROMATO/CHROMED



G•LIBERTY 01

GYSC10601

20 x 42 x 100 cm

BRONZO/BRONZE



G•LIBERTY 02

GYSC10602

20 x 42 x 100 cm

RAME/COPPER





G•SHOWER COLUMN

G•LIGHT

G•MUSIC

G•LIGHT OO

GYSC10800
20 x 45 x 100 cm
CROMATO/CHROMED

G•MUSIC OO

GYSC10900
23 x 51 x 91 cm
CROMATO-BIANCO/
WHITE-CHROMED



BLUETOOTH



G•SHOWER PANEL

A lato dei moderni pannelli in acciaio inox in finitura spazzolata, Gedy presenta anche una collezione di pannelli doccia multifunzione in vetro temperato ultralight laccato in colorazioni abbinabili con la sua enorme gamma di accessori e complementi per il bagno.

Outre les panneaux modernes en acier inox dans la finition brossée, Gedy présente une collection de panneaux de douche multifonction en verre trempé ultralight laqué dans des couleurs à assortir à sa gamme considérable d'accessoires et d'éléments de décoration pour la salle de bains.

Además de los modernos paneles de acero inoxidable con acabado cepillado, Gedy presenta también una colección de paneles ducha multifunción de vidrio templado ultralight laqueado en colores combinables con su enorme gama de accesorios y complementos para el baño.

Alongside the modern panels in stainless steel with brushed finish, Gedy also has a collection of multipurpose shower panels in ultralight tempered glass, which combine with its enormous range of accessories and complementary features for the bathroom.

Neben den moderne Paneelen aus gebürstetem Edelstahl bietet Gedy auch eine Kollektion von Multifunktionsduschpaneelen aus utraleichem gehärtetem Glas an, lackiert in Farben, die mit der enormen Palette der Accessoires für das Bad kombiniert werden kann.

Наряду с душевыми панелями из нержавеющей стали с отделкой «эффект щетки» Gedy представляет также коллекцию душевых многофункциональных панелей из суперлегкого закаленного стекла, покрытого цветным лаком, который можно сочетать с множеством аксессуаров и дополнений для ванной.



Pioggia
Rain
Pluie
Regen
Lluvia
Дождик



Idromassaggio
Massage jet
Jet de massage
Messagestrahl
Chorro masaje
массажная струя



Morbido
Soft
Moelleux
Weich
Suave
Мягкая



Doppio relax
Double relax
Double détente
Doppleter Relax
Doble Relax
Супер релакс





G•STYLE OO

GYSP10000

20 x 41 x 130 cm



Argento
Silver
Argent
Silber
Plata
серебро



RAIN



RAIN



G•STYLE O1

GYSP10001

20 x 41 x 130 cm



Bianco
White
Blanc
Weiss
Blanco
белый

Miscelatore manuale

Manual mixer
Mitigeur manuel
Manueller Mischer
Mezclador manual
Ручной миксер

Vetro temperato
Tempered glass
Verre tempéré
Sekuritglas
Cristal templado
закаленное стекло

ABS/Acciaio inox/Ottone/Vetro

ABS/Stainless steel/Brass/Glass
ABS/Acier inox/Laiton/Verre
ABS/Edelstahl/Messing/Glas
ABS/Acero inox/Latón/Vidrio
АБС/Нержавеющая сталь/
Латунь/Стекло

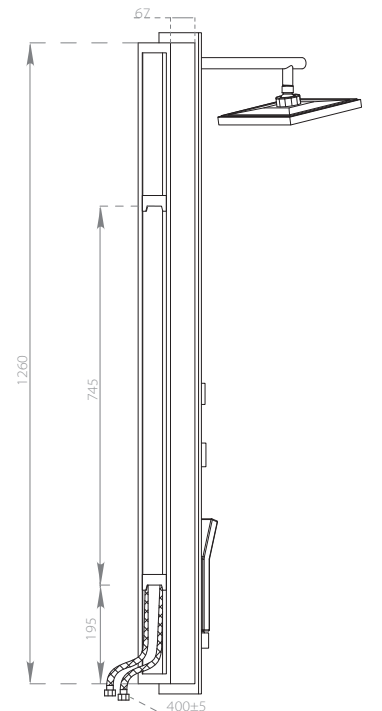
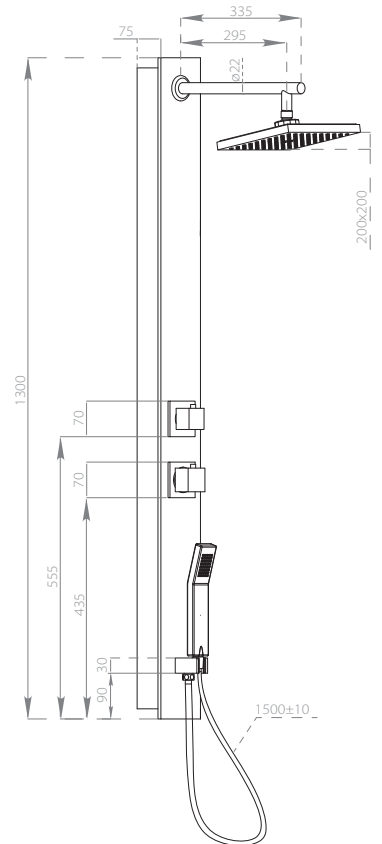

G•SHOWER PANEL

Argento
Silver
Argent
Silber
Plata
серебро

G•STYLE PLUS OO

GYSP10100

20 x 41 x 130 cm



Miscelatore termostatico
Thermostatic mixer
Mitigeur thermostatique
Thermostatmischer
Mezclador termostático
Термостатический смеситель

Vetro temperato
Tempered glass
Verre tempéré
Sekuritglas
Cristal templado
закаленно стекло

ABS/Acciaio inox/Ottone/Vetro
ABS/Stainless steel/Brass/Glass
ABS/Acier inox/Laiton/Verre
ABS/Edelstahl/Messing/Glas
ABS/Acero inox/Latón/Vidrio
АБС/Нержавеющая сталь/
Латунь/Стекло

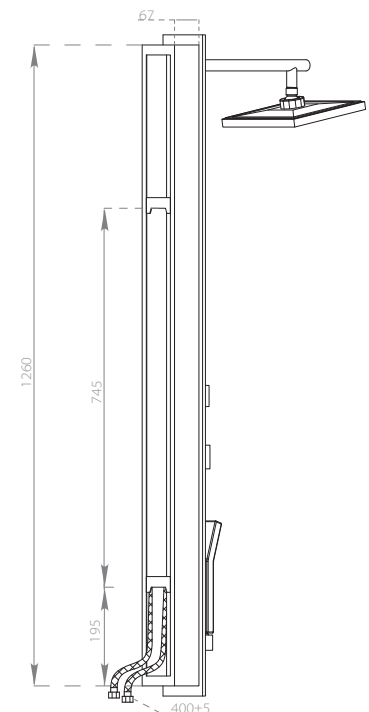
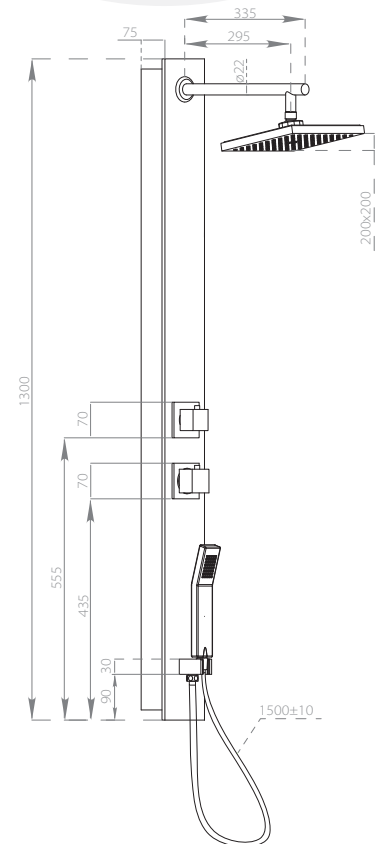



G•SHOWER PANEL

Inox spazzolato
 Brushed stainless steel
 Acier inoxydable brossé
 Edelstahl gebürstet
 Acero inoxidable cepillado
 Матовая нержавеющая сталь

G•CASCADE OO

GYSP10200
 17,5 x 50,5 x 154 cm

Miscelatore manuale
 Manual mixer
 Mitigeur manuel
 Manueller Mischer
 Mezclador manual
 Ручной миксер



G•CASCADE PLUS OO

GYSP10300
 17,5 x 50,5 x 154 cm

Miscelatore termostatico
 Thermostatic mixer
 Mitigeur thermostatique
 Thermostatmischer
 Mezclador termostático
 Термостатический смеситель



ABS/Acciaio inox/Ottone
 ABS/Stainless steel/Brass
 ABS/Acier inox/Laiton
 ABS/Edelstahl/Messing
 ABS/Acero inox/Latón
 ABS/Нержавеющая сталь/Латунь

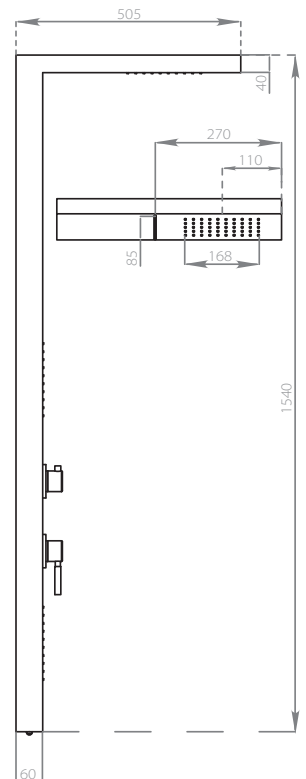
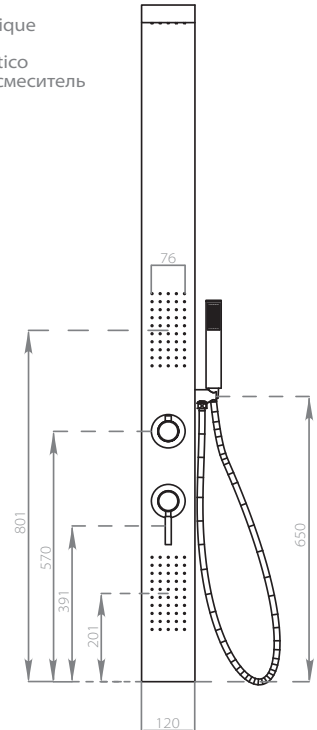



G•SHOWER PANEL

Inox spazzolato
 Brushed stainless steel
 Acier inoxydable brossé
 Edelstahl gebürstet
 Acero inoxidable cepillado
 Матовая нержавеющая сталь

G•MESSAGE O1

GYSP10401

20,7 x 47,5 x 161 cm



WELLNESS



RAIN

Miscelatore manuale
 Manual mixer
 Mitigeur manuel
 Manueller Mischer
 Mezclador manual
 Ручной миксер

ABS/Acciaio inox/Ottone
 ABS/Stainless steel/Brass
 ABS/Acier inox/Laiton
 ABS/Edelstahl/Messing
 ABS/Acero inox/Latón
 АБС/Нержавеющая сталь/Латунь

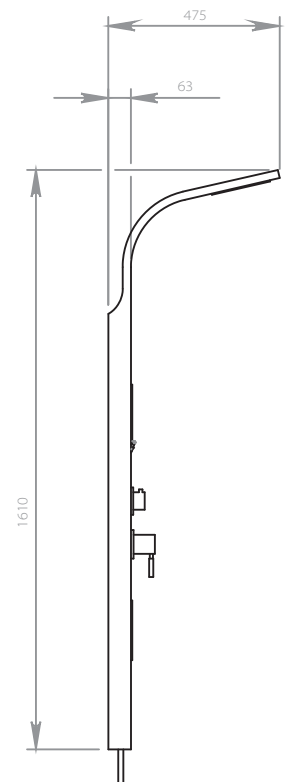
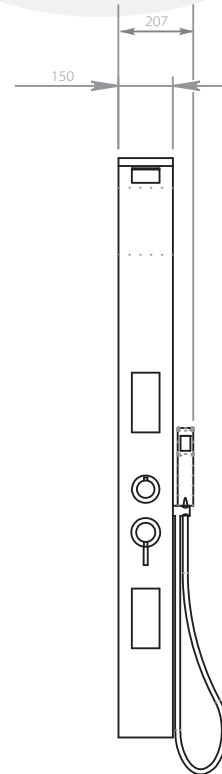



G•SHOWER PANEL

G•WELLNESS 00

GYSP10500
25 x 55 x 145 cm



■ Nero
Black
Noir
Schwarz
Negro
чернота

G•WELLNESS 01

GYSP10501
25 x 55 x 145 cm

□ Bianco
White
Blanc
Weiss
Blanco
белый

Miscelatore termostatico
Thermostatic mixer
Mitigeur thermostatique
Thermostatmischer
Mezclador termostático
Термостатический смеситель

ABS/Acciaio inox/Ottone
ABS/Stainless steel/Brass
ABS/Acier inox/Laiton
ABS/Edelstahl/Messing
ABS/Acero inox/Latón
АБС/Нержавеющая
сталь/Латунь

G•WELLNESS 02

GYSP10502
25 x 55 x 145 cm

■ Inox spazzolato
Brushed stainless
steel
Acier inoxydable
brossé
Edelstahl gebürstet
Acero inoxidable
cepillado
Матовая
нержавеющая сталь

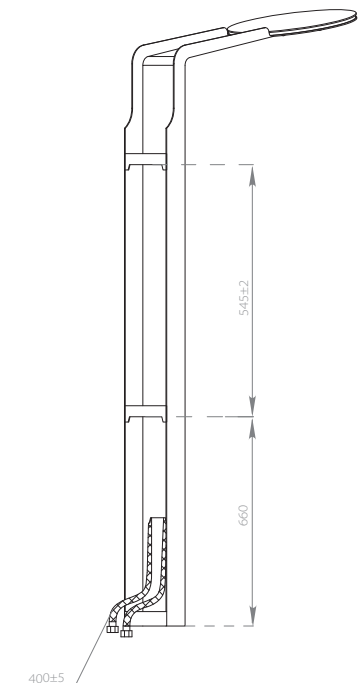
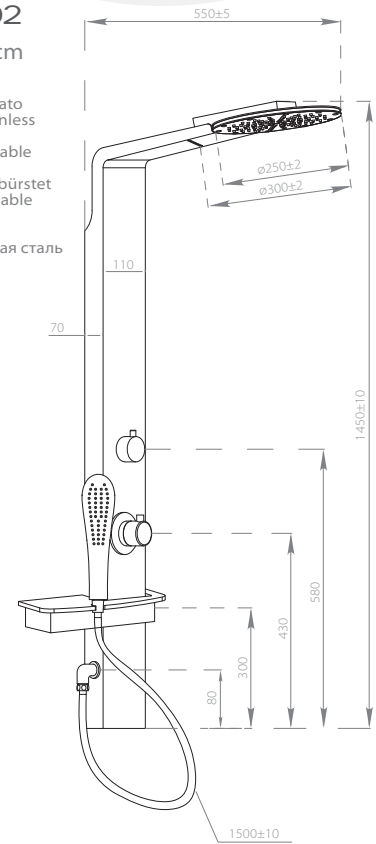



ABS/Acciaio inox/Ottone
ABS/Stainless steel/Brass
ABS/Acier inox/Laiton
ABS/Edelstahl/Messing
ABS/Acero inox/Latón
АБС/Нержавеющая сталь/Латунь

G•SHOWER PANEL

G•SPA 00

GYSP10600
20 x 45 x 167 cm

 Bianco
White
Blanc
Weiss
Blanco
белый

G•SPA 01

GYSP10601
20 x 45 x 167 cm

 Nero
Black
Noir
Schwarz
Negro
чернота

G•SPA 02

GYSP10602
20 x 45 x 167 cm

 Inox spazzolato
Brushed stainless steel
Acier inoxydable brossé
Edelstahl gebürstet
Acero inoxidable cepillado
Матовая нержавеющая сталь



Miscelatore termostatico
Thermostatic mixer
Mitigeur thermostatique
Thermostatmischer
Mezclador termostático
Термостатический смеситель

ABS/Acciaio inox/Ottone
ABS/Stainless steel/Brass
ABS/Acier inox/Laiton
ABS/Edelstahl/Messing
ABS/Acero inox/Latón
АБС/Нержавеющая
сталь/Латунь

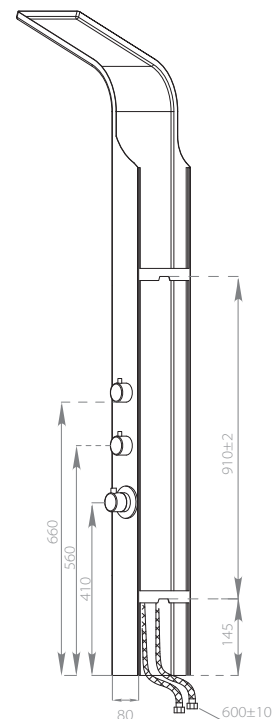
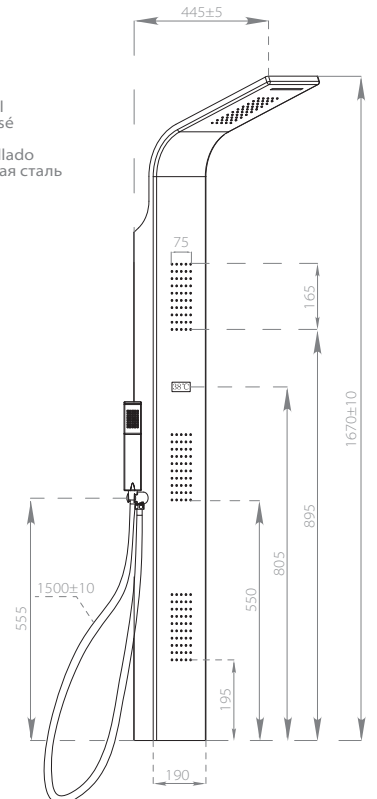

G•SHOWER HEAD



Largo ventaglio di misure, funzioni, forme e materiali per i soffioni doccia Gedy, tutti dotati di filtro antisabbia, tecnologia water saving, tettarelle che permettono una rapida rimozione manuale del calcare.

Vaste gammes de dimensions, de fonctions, de formes et de matériaux pour les pommes de douche Gedy, toutes munies d'un filtre anti-sable, suivant la technologie water saving, des picots qui permettent une élimination manuelle rapide du calcaire.

Amplio abanico de medidas, funciones, formas y materiales para los rociadores ducha Gedy, todos dotados de filtro anti-arena, tecnología para el ahorro de energía, eyectores que permiten una rápida remoción manual de la cal.

Wide range of size, functions, shapes and materials for Gedy shower heads, all with sand filter, water saving technology and nipples for easy scale removal by hand.

Große Vielfalt von Größen, Funktionen, Formen und Materialien für die Duschstrahler Gedy, alle ausgestattet mit Sandfilter, Water-Saving-Technologie und Einsatz für die schnelle Entfernung von Kalkablagerungen.

Ассортимент леек Gedy представлен богатым выбором размеров, функций, форм и материалов. Все они оснащены фильтром для задержки песка, регулятором расхода воды и легко чистящимися от скопившейся накипи соплами.

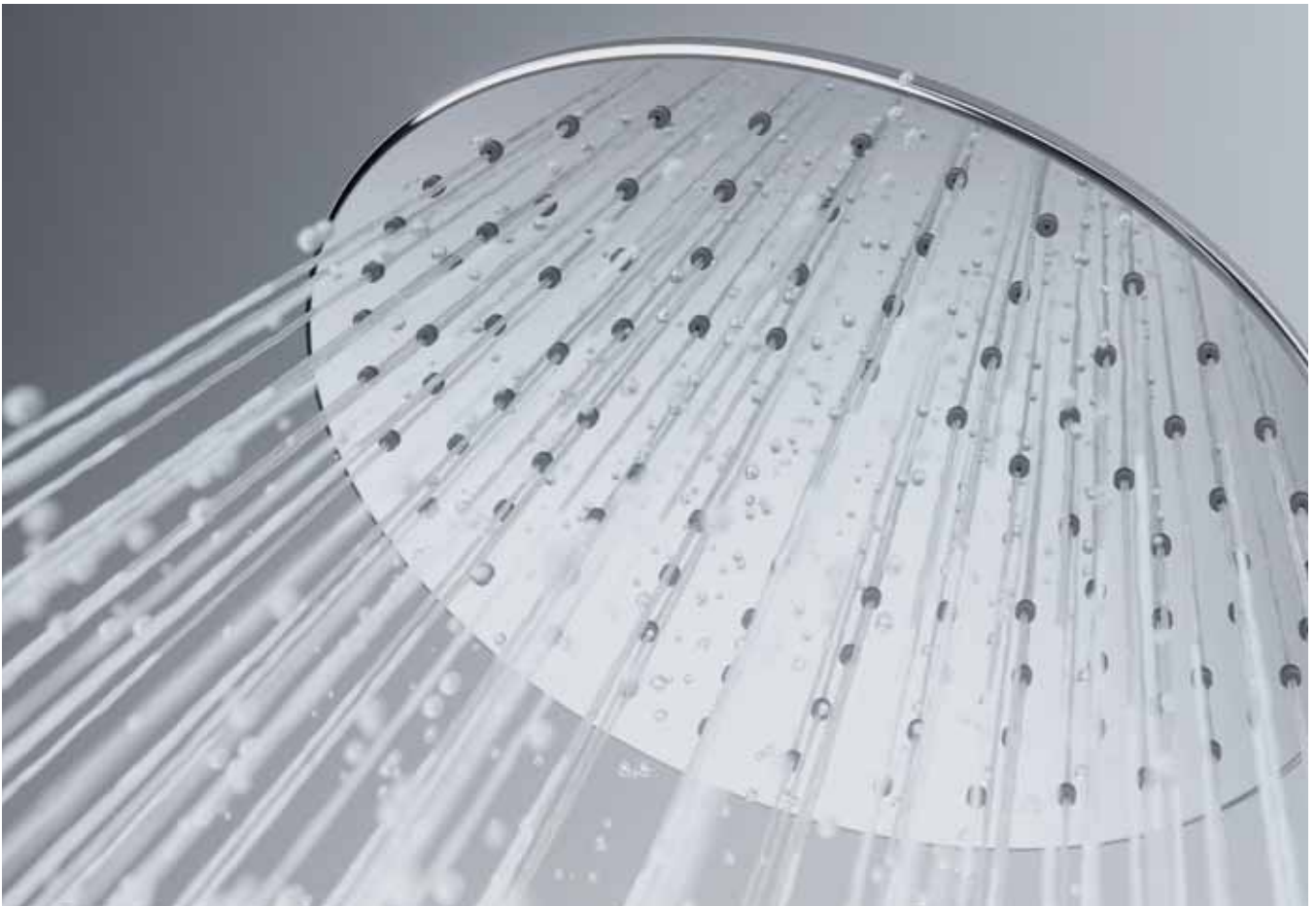

Filtro Antisabbia
Sand filter
Filtre anti-sable
Sandschutzfilter
Filtro antirena
Универсальное крепление



Water Saving



Anticalcare
Anti-limestone
Anticalcaire
Kesselsteinlösemittel
Antical
Защита от известкового налета



Pioggia
Rain
Pluie
Regen
Lluvia
Дождик



Morbido
Soft
Moelleux
Weich
Suave
Мягкая



Sottile
Thin
Fin
Leicht
Fino
Тонкая



Doppio relax
Double relax
Double détente
Doppleter Relax
Doble Relax
Супер релакс



Nebulizzato
Spray
Nébulisé
Zerstäubt
Nebulizado
Распыление

Connessione
UNIVERSALE
Universal
CONNECTION



col. 13
Cromato/CHROMED
Chromé
Chrom
Cromado
Хром

G•EASY 00

GYSH10000

ø 7,2 x 9,5 cm

CROMATO/
CHROMED**G•EASY 01**

GYSH10001

ø 7 x 10,5 cm

CROMATO/
CHROMED**G•EASY 02**

GYSH10002

ø 7 x 8,5 cm

CROMATO/
CHROMED**G•EASY 03**

GYSH10003

ø 10,2 x 6,5 cm

CROMATO/
CHROMED**G•EASY 04**

GYSH10004

ø 10 x 8,5 cm

CROMATO/
CHROMED

RAIN

TONIC

MASSAGE

RAIN+TONIC

RAIN+MASSAGE

**G•PLUS 00**

GYSH10100

20 x 20 x 5,5 cm

CROMATO/
CHROMED**G•PLUS 01**

GYSH10101

ø 20 x 5 cm

CROMATO/
CHROMED**G•PLUS 02**

GYSH10102

ø 20 x 6 cm

CROMATO/
CHROMED

G•PLUS 04

GYSH10104

ø 23 x 5 cm

CROMATO/
CHROMED

RAIN

G•PLUS 05

GYSH10105

ø 23 x 5 cm

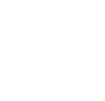
CROMATO-BIANCO/
WHITE-CHROMED

RAIN

G•PLUS 06

GYSH10105

ø 23 x 5 cm

NICHEL SPAZZOLATO/
BRUSHED NICKEL

RAIN

G•PLUS 03

GYSH10103

20 x 20 x 6 cm

CROMATO/
CHROMED

RAIN

G•STAR 02

GYSH10202

25 x 25 x 6 cm

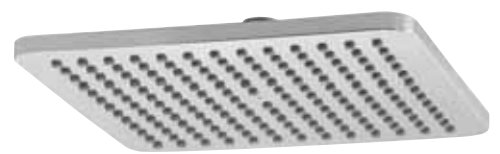
CROMATO/
CHROMED

RAIN

G•LIGHT 00

GYSH10700

ø 20,5 x 8 cm

CROMATO/
CHROMED

RAIN

COLOR
CHANGE**G•STAR 04**

GYSH10204

ø 25 x 5 cm

CROMATO/
CHROMED

RAIN

G•LIGHT 03

GYSH10703

ø 25 x 8 cm

CROMATO/
CHROMED

RAIN

COLOR
CHANGE**G•MUSIC 00**

GYSH11100

ø 23 x 9 cm

CROMATO-BIANCO/
WHITE-CHROMED

RAIN



BLUETOOTH

G•TECH 00

GYSH10300

ø 30 x 5 cm

CROMATO/
CHROMEDAcciaio inox AISI 304
Stainless steel 304 AISI
Acier inox 304 AISI
Rostfreier Stahl 304 AISI
Acero inoxidable 304 AISI
Нержавеющая сталь 304 AISI

RAIN

**G•TECH 02**

GYSH10302

ø 20 x 5 cm

G•TECH 06

GYSH10306

ø 40 x 5 cm

G•TECH 04

GYSH10304

ø 25 x 5 cm

G•TECH 08

GYSH10308

ø 50 x 5 cm

G•TECH 01

GYSH10301

30 x 30 x 5 cm

CROMATO/
CHROMEDAcciaio inox AISI 304
Stainless steel 304 AISI
Acier inox 304 AISI
Rostfreier Stahl 304 AISI
Acero inoxidable 304 AISI
Нержавеющая сталь 304 AISI

RAIN

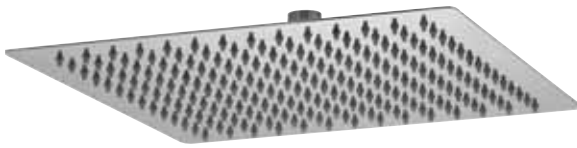
**G•TECH 03**

GYSH10303

20 x 20 x 5 cm

G•TECH 07

GYSH10307

40 x 40 x 5 cm

G•TECH 05

GYSH10305

25 x 25 x 5 cm

G•TECH 09

GYSH10309

50 x 50 x 5 cm

G•LIBERTY 00

GYSH10600

ø 20,5 x 10 cm

CROMATO/
CHROMED

RAIN

**G•LIBERTY 01**

GYSH10601

ø 20,5 x 10 cm

BRONZO/BRONZE

G•LIBERTY 02

GYSH10602

ø 20,5 x 10 cm

RAME/COPPER

G•DESIGN 01 design Simone Micheli

GYSH10501

ø 50 x 1,5 cm

CROMATO BIANCO/
WHITE CHROMED

RAIN



Novità - New

G•FLEX

Tutti dotati di attacco universale 1/2" e di doppia aggraffatura, i flessibili Gedy sono presentati in un ampio ventaglio di materiali, finiture e misure disponibili.

Tous munis d'un raccord universel de 1/2 pouce et d'un double agrafage, les tuyaux flexibles Gedy sont présentés dans une vaste gamme de matériaux, de finitions et de dimensions.

Todos dotados de conexión universal 1/2" y de engrapado doble, los flexos Gedy están disponibles con un amplio abanico de materiales, acabados y medidas.

All complete with universal 1/2" fitting and dual crimping. Gedy hoses are available in a wide range of materials, finishes and sizes.

Alle ausgestattet mit Universalanschluss 1/2" und doppelter Rändelung: die Schläuche Gedy werden in einer Vielzahl von Materialien, Verarbeitungen und Größen angeboten.

Все шланги Gedy в двойной оплетке и имеют универсальное соединение 1 / 2", в наличии большой выбор материалов, отделок и размеров.



G•BRASS 04

GYFX10004

ø 1,4 x 150-200 cm

CROMATO/
CHROMED



G•INOX 00

GYFX10100

ø 1,4 x 150 cm

CROMATO/
CHROMED



G•INOX 01

GYFX10101

ø 1,4 x 200 cm

CROMATO/
CHROMED



G•INOX 02

GYFX10102

ø 1,4 x 150 cm

CROMATO/
CHROMED



G•INOX 03

GYFX10103

ø 1,4 x 200 cm



G•INOX 04

GYFX10104

ø 1,4 x 150-200 cm

CROMATO/
CHROMED**G•INOX 05**

GYFX10105

ø 1,4 x 150 cm

BRONZO/
BRONZE**G•INOX 06**

GYFX10106

ø 1,4 x 200 cm

G•INOX 07

GYFX10107

ø 1,4 x 150 cm

RAME/COPPER

**G•INOX 08**

GYFX10108

ø 1,4 x 200 cm

G•INOX 09

GYFX10109

ø 1,4 x 150 cm

NICHEL SPAZZOLATO
BRUSHED NICKEL**G•INOX 10**

GYFX10110

ø 1,4 x 200 cm

G•INOX 11

GYFX10111

ø 1,4 x 150 cm

INOX SPAZZOLATO
BRUSHED STAINLESS**G•INOX 12**

GYFX10112

ø 1,4 x 200 cm

G•WHITE 00

GYFX10200

ø 1,4 x 150 cm

BIANCO / WHITE

**G•WHITE 01**

GYFX10201

ø 1,4 x 200 cm

G•DOUBLE WHITE 00

GYFX10300

ø 1,4 x 150 cm

CROMATO BIANCO/
WHITE CHROMED**G•DOUBLE WHITE 01**

GYFX10301

ø 1,4 x 200 cm

G•DOUBLE BLACK OO

GYFX10400

ø 1,4 x 150 cm

CROMATO NERO/
BLACK CHROMED**G•DOUBLE BLACK O1**

GYFX10401

ø 1,4 x 200 cm

G•SUPER WHITE OO

GYFX10500

ø 1,4 x 150 cm

CROMATO BIANCO/
WHITE CHROMED**G•SUPER WHITE O1**

GYFX10501

ø 1,4 x 200 cm

G•SUPER BLACK OO

GYFX10600

ø 1,4 x 150 cm

CROMATO NERO/
BLACK CHROMED**G•SUPER BLACK O1**

GYFX10601

ø 1,4 x 200 cm

G•SILVER OO

GYFX10700

ø 1,4 x 150 cm

ARGENTO/SILVER

**G•SILVER O1**

GYFX10701

ø 1,4 x 200 cm

G•ACCESSORIES

Varie possibilità di sostituzione di accessori e particolari per la zona doccia, dai supporti per le doccette e i saliscendi, ai kit per la sostituzione areatori in varie misure, alle prese d'acqua, deviatori e braccetti con connessione universale.

Différentes possibilités de remplacement d'accessoires et de pièces pour la zone douche : supports de douchette, barres de douche, kits pour le remplacement des aérateurs dans différentes dimensions, prises d'eau, déviateurs et bras avec connexion universelle.

Varias posibilidades de sustitución de accesorios y detalles para la zona ducha, desde los soportes para los mangos de ducha y los soportes deslizantes, los kits para la sustitución aireadores de varias medidas, hasta las toma de agua, los desviadores y los brazos con conexión universal.

A host of replacement possibilities for accessories and details for the shower area, from brackets to sliding bars, kits for aerator replacement in different sizes, water inlets, deflectors and brackets with universal connection.

Erschiedene Möglichkeiten der Ersetzung von Zubehör- und Ersatzteile im Duschenbereich, von den Handduschenhalterungen zu den Wandschienen und von den Kits für die Ersetzung der Lüfter in verschiedenen Größen zu den Wasseranschlüssen, Umleitern und Armen mit Universalanschluss.

Богатый ассортимент аксессуаров и дополнений для душа, начиная от держателей для ручных душей и штанг до наборов для смены аэраторов различных размеров, соединений для подвода воды, девиаторов и держателей с универсальным креплением.



G•BAR EASY 00

GYAC10000

11,6 x 8 x 60,5 cm - ø 1,9 cm

CROMATO/CHROMED



G•BAR EASY 01

GYAC10001

11,2 x 5 x 65 cm

CROMATO/CHROMED



G•BAR STAR 00

GYAC10100

ø 2,5 x 75-90 cm

CROMATO/CHROMED



G•BAR STAR O1

GYAC10101

ø 2,5 x 75-90 cm

CROMATO/
CHROMED**G•BAR TENDENCE OO**

GYAC10200

12 x 7,5 x 66 cm

BIANCO/WHITE

**G•BAR STAR O2**

GYAC10102

ø 2,5 x 75-90 cm

NICHEL SPAZZOLATO
BRUSHED NICKEL**G•BAR TENDENCE O1**

GYAC10201

12 x 7,5 x 66 cm

NERO/BLACK

**G•BAR TENDENCE O2**

GYAC10202

cm 13,5 x 20 x 80 - ø 2,5 cm

CROMATO BIANCO/
WHITE CHROMED**G•BAR LIBERTY OO**

GYAC10300

ø 8 x 16 x 70 - ø 2,5 cm

CROMATO - CHROMED

**G•BAR TENDENCE O3**

GYAC10202

cm 13,5 x 20 x 80 - ø 2,5 cm

CROMATO NERO/
BLACK CHROMED**G•BAR LIBERTY O1**

GYAC10301

ø 8 x 16 x 70 - ø 2,5 cm

BRONZO - BRONZE

**G•BAR LIBERTY O2**

GYAC10302

ø 8 x 16 x 70 - ø 2,5 cm

RAME - COPPER





G•SLIDER OO

GYAC99002

ø 4 x 12 cm

CROMATO - CHROMED

ABS

SUPPORTO DOCCETTA UNIVERSALE PER ASTA SALISCENDI
UNIVERSAL HEAD SHOWER SUPPORT FOR SLIDING RAIL**G•CLIP EASY OO**

GYAC10400

ø 4 x 5 cm

CROMATO - CHROMED

ABS

SUPPORTO DOCCETTA FISSO - CONNESSIONE UNIVERSALE
FIXED SHOWER BRACKET - UNIVERSAL CONNECTION**G•CLIP EASY O1**

GYAC10401

ø 6 x 6,8 cm

CROMATO - CHROMED

ABS

SUPPORTO DOCCIA FISSO CON VENTOSA, 1 POSIZIONE
SUCTION CUP FIXED SHOWER BRACKET, 1 POSITION**G•CLIP EASY O2**

GYAC10402

ø 9,6 X 6 x 8,6 cm

CROMATO - CHROMED

ABS

SUPPORTO DOCCIA FISSO CON VENTOSA, 2 POSIZIONI
SUCTION CUP FIXED SHOWER BRACKET, 2 POSITIONSSolo su superfici lisce (specchi, piastrelle)
For flat surfaces (mirrors, tiles) onlyFissaggio con ventosa - Suction cup fixing
Fixation avec ventouses - Befestigung mit Saugnapfen
Fijación con ventosas - Крепление при помощи присосокSolo su superfici lisce (specchi, piastrelle)
For flat surfaces (mirrors, tiles) onlyFissaggio con ventosa - Suction cup fixing
Fixation avec ventouses - Befestigung mit Saugnapfen
Fijación con ventosas - Крепление при помощи присосок

G•CLIP PLUS 00

GYAC10500

4 x 6,3 x 5,5 cm

CROMATO GRIGIO/
GREY CHROMED
ABS**SUPPORTO DOCCIA MOBILE**
MOBILE SHOWER BRACKET**G•CLIP PLUS 01**

GYAC10501

4 x 6,3 x 5,5 cm

CROMATO BIANCO/
WHITE CHROMED
ABS**G•CLIP PLUS 03**

GYAC10503

4 x 6,3 x 5,5 cm

NICHEL SPAZZOLATO/BRUSHED NICKEL
ABS**G•CLIP PLUS 02**

GYAC10502

4 x 6,3 x 5,5 cm

CROMATO NERO/
BLACK CHROMED
ABS**G•CLIP STAR 00**

GYAC10600

7,1 x 10,2 x 3,4 cm

CROMATO/CHROMED
ABS**SUPPORTO DOCCIA MOBILE**
MOBILE SHOWER BRACKET**G•CLIP TECH 00**

GYAC10700

9 x 7 x 4,2 cm

CROMATO/CHROMED
ABS**SUPPORTO DOCCIA MOBILE**
MOBILE SHOWER BRACKET**G•CLIP LIBERTY 00**

GYAC10800

ø 6 x 10 cm

CROMATO-OTTONE
CHROMED-BRASS**G•CLIP LIBERTY 01**

GYAC10801

ø 6 x 10 cm

BRONZO-OTTONE
BRONZE-BRASS**SUPPORTO DOCCIA MOBILE**
MOBILE SHOWER BRACKET**G•CLIP LIBERTY 02**

GYAC10802

ø 6 x 10 cm

RAME- OTTONE
COPPER-BRASS**G•CLIP LIBERTY 04**

GYAC10804

ø 6 x 10 cm

CROMATO - CHROMED
ABS**SUPPORTO DOCCIA MOBILE**
MOBILE SHOWER BRACKET

G•OXY EASY 00

GYAC10900

6 x 7 x 3,7 cm

CROMATO-OTTONE/
CHROMED-BRASS**G•OXY EASY 01**

GYAC10901

6 x 7 x 3,7 cm

BRONZO-OTTONE/
BRONZE-BRASS**G•OXY EASY 02**

GYAC10902

6 x 7 x 3,7 cm

RAME-OTTONE/
COPPER-BRASS**G•OXY EASY 03**

GYAC10903

6 X 7 X 3,7 cm

NICHEL SPAZZOLATO-OTTONE/
BRUSHED NICKEL-BRASS**G•OXY EASY 04**

GYAC10904

6,2 x 4,8 x 5,2 cm

CROMATO - CHROMED
ABS**G•OXY EASY 05**

GYAC10905

6 x 7 x 3,7 cm

CROMATO-OTTONE/
CHROMED -BRASS**G•OXY PLUS 00**

GYAC11000

5 x 5,5 x 6,5 cm

CROMATO-OTTONE/ CHROMED -BRASS

**G•OXY PLUS 01**

GYAC11001

5 x 5,5 x 6,5 cm

BRONZO-OTTONE/
BRONZE-BRASS**G•OXY PLUS 02**

GYAC11002

5 x 5,5 x 6,5 cm

RAME-OTTONE/
COPPER-BRASS**G•OXY PLUS 03**

GYAC11003

5 x 5,5 x 6,5 cm

NICHEL SPAZZOLATO-OTTONE/
BRUSHED NICKEL-BRASS**G•OXY STAR 00**

GYAC11100

5 x 6 x 5 cm

CROMATO - CHROMED
OTTONE-BRASS**G•OXY TECH 00**

GYAC11200

4,7 x 6 x 5 cm

CROMATO - CHROMED
OTTONE-BRASS

G•OXY CLIP EASY 00

GYAC11300

5,5 x 8 x 5,8 cm

CROMATO - CHROMED
OTTONE-BRASS**G•OXY CLIP PLUS 00**

GYAC11400

5 x 8,5 x 5,5 cm

CROMATO - CHROMED
OTTONE-BRASS**G•OXY MIX 01**

GYAC10601

6 x 7,2 x 5,2 cm

CROMATO - CHROMED
OTTONE-BRASS**G•OXY MIX 02**

GYAC11602

5 x 7,6 x 5,2 cm

CROMATO - CHROMED
OTTONE-BRASS**G•OXY MIX CLIP 03**

GYAC11603

9,8 x 7 x 6,5 cm

CROMATO - CHROMED
OTTONE-BRASS**G•OXY MIX CLIP 04**

GYAC11604

9,5 x 6,8 x 5,4 cm

CROMATO - CHROMED
OTTONE-BRASS**G•SOAPY EASY 00**

GYAC11700

8 x 17 x 3,5 cm

CROMATO - CHROMED
ABS

Ø 18-20-22-25 mm

G•SOAPY EASY 01

GYAC11701

10,3 x 13 x 3,2 cm

CROMATO - CHROMED
ABS

Ø 18-20-22-25 mm

G•SOAPY STAR 00

GYAC11800

25 x 10 x 3 cm

CROMATO - CHROMED
ABS

Ø 18-20-22-25 mm

G•CROSS EASY 00

GYAC11900

6,5 x 2,5 x 6,5 cm

CROMATO - CHROMED
OTTONE - BRASS**G•CROSS EASY 04**

GYAC11904

7 x 2,3 x 7,5 cm

CROMATO - CHROMED
ABS**G•CROSS EASY 05**

GYAC11905

6,5 x 2,5 x 6,5 cm

CROMATO-OTTONE/
CHROMED - BRASS**G•CROSS TRENDY 00**

GYAC12000

6 x 3 x 6,2 cm

CROMATO-OTTONE/
CHROMED - BRASS**G•TUBE EASY 00**

GYAC12100

Ø 2 x 15 cm

CROMATO - CHROMED
ACCIAIO INOX
STAINLESS STEEL**G•TUBE PLUS 15 00**

GYAC12300

Ø 6 x 15 cm

CROMATO - CHROMED
ACCIAIO INOX - STAINLESS STEEL**G•TUBE TRENDY 15 00**

GYAC12500

Ø 2,5 x 2,5 x 15 cm

CROMATO-OTTONE/
CHROMED - BRASS

G•TUBE STAR 25 00

GYAC12600

ø 6 x 25 cm

CROMATO - CHROMED

ACCIAIO INOX - STAINLESS STEEL

G•TUBE STAR 30 00

GYAC12700

ø 2 x 30 cm

CROMATO - CHROMED

ACCIAIO INOX - STAINLESS STEEL

G•TUBE STAR 35 00

GYAC12800

ø 5,5 x 37,2 x 11 cm

CROMATO - CHROMED

ACCIAIO INOX - STAINLESS STEEL

G•TUBE STAR 35 01

GYAC12801

ø 2 x 35 cm

BRONZO - BRONZE

ACCIAIO INOX - STAINLESS STEEL

G•TUBE STAR 35 02

GYAC12802

ø 2 x 35 cm

RAME - COPPER

ACCIAIO INOX - STAINLESS STEEL

G•TUBE STAR 35 03

GYAC12803

ø 2 x 35 cm

NICHEL SPAZZOLATO - BRUSHED NICKEL

ACCIAIO INOX - STAINLESS STEEL

G•TUBE STAR 40 00

GYAC12900

ø 2 x 40 cm

CROMATO - CHROMED

ACCIAIO INOX - STAINLESS STEEL

**G•TUBE TECH 25 00**

GYAC13000

2,5 x 2,5 x 25 cm

CROMATO - CHROMED

OTTONE-BRASS

G•TUBE TECH 30 00

GYAC13100

2,5 x 2,5 x 30 cm

CROMATO - CHROMED

OTTONE-BRASS

G•TUBE TECH 35 00

GYAC13200

2,5 x 2,5 x 35 cm

CROMATO - CHROMED

OTTONE-BRASS

**G•TUBE TECH 40 00**

GYAC13300

2,5 x 2,5 x 40 cm

CROMATO - CHROMED

OTTONE-BRASS

G•TUBE TOP 30 00

GYAC13400

3,5 x 1,5 x 30 cm

CROMATO - CHROMED

ACCIAIO INOX - STAINLESS STEEL

G•TUBE TOP 35 00

GYAC13500

3,5 x 1,5 x 35 cm

CROMATO - CHROMED

ACCIAIO INOX - STAINLESS STEEL

G•TUBE TOP 40 00

GYAC13600

3,5 x 1,5 x 40 cm

CROMATO - CHROMED

ACCIAIO INOX - STAINLESS STEEL

**G•TUBE TOP 45 00**

GYAC13700

3,5 x 1,5 x 45 cm

CROMATO - CHROMED

ACCIAIO INOX - STAINLESS STEEL

G•TUBE LIBERTY 00

GYAC13800

6 x 28 x 30 cm

CROMATO - CHROMED
 ACCIAIO INOX -
 STAINLESS STEEL

**G•TUBE LIBERTY 01**

GYAC13801

6 x 28 x 30 cm

BRONZO - BRONZE
 ACCIAIO INOX - STAINLESS STEEL

G•TUBE LIBERTY 02

GYAC13802

6 x 28 x 30 cm

RAME - COPPER
 ACCIAIO INOX - STAINLESS STEEL

G•SPRAY TECH 00

GYAC99300

5,8 x 12,4 x 2,2 cm

CROMATO - CHROMED
 OTTONE-BRASS

**G•SPRAY TECH 01**

GYAC99301

6,2 x 12,4 x 2,2 cm

CROMATO - CHROMED
 OTTONE-BRASS



G•HYDRAULICS

G•FLEXY O0

GHHY10000

ø 3 x 15 cm

BIANCO - WHITE
PVC - ACCIAIO INOX
PVC - STAINLESS STEEL



G•FLEXY O1

GHHY10001

ø 3 x 9 cm

BIANCO - WHITE
PVC - ACCIAIO INOX
PVC - STAINLESS STEEL



G•FLEXY O2

GHHY10002

ø 4 x 12 cm

CROMATO - CHROMED
PVC - ACCIAIO INOX
PVC - STAINLESS STEEL



G•FLEXY O3

GHHY10003

ø 3 x 6 cm

CROMATO - CHROMED
PVC - ACCIAIO INOX
PVC - STAINLESS STEEL



G•WATER SAVING O1

GHHY10401

ø 2,2 x 2 cm

CROMATO - CHROMED
ABS - OTTONE
ABS - BRASS



G•WATER SAVING O2

GHHY10402

ø 3 x 4,2 cm

CROMATO - CHROMED
ABS - OTTONE
ABS - BRASS



G•JOINT 00

GHY10500

ø 2,5 x 4,5 cm

CROMATO - CHROMED
 ACCIAIO INOX - OTTONE
 STAINLESS STEEL - BRASS

**G•JOINT 01**

GHY10501

ø 2,5 x 4,5 cm

CROMATO - CHROMED
 ACCIAIO INOX - OTTONE
 STAINLESS STEEL - BRASS

**G•KEY 00**

GHY10600

5 x 2 x 8 cm

BLU - BLUE
 ABS

**G•AERATOR 00**

GHY10700

ø 2,2 x 1,5 cm

CROMATO - CHROMED
 ACCIAIO INOX - OTTONE
 STAINLESS STEEL - BRASS

**G•AERATOR 01**

GHY10701

ø 2,2 x 1 cm

CROMATO - CHROMED
 ACCIAIO INOX - OTTONE
 STAINLESS STEEL - BRASS

**G•AERATOR 02**

GHY10702

ø 2,4 x 1 cm

CROMATO - CHROMED
 ACCIAIO INOX - OTTONE
 STAINLESS STEEL - BRASS

**G•AERATOR 02**

GYAC12703

ø 2,8 x 1 cm

CROMATO - CHROMED
 ACCIAIO INOX - OTTONE
 STAINLESS STEEL - BRASS

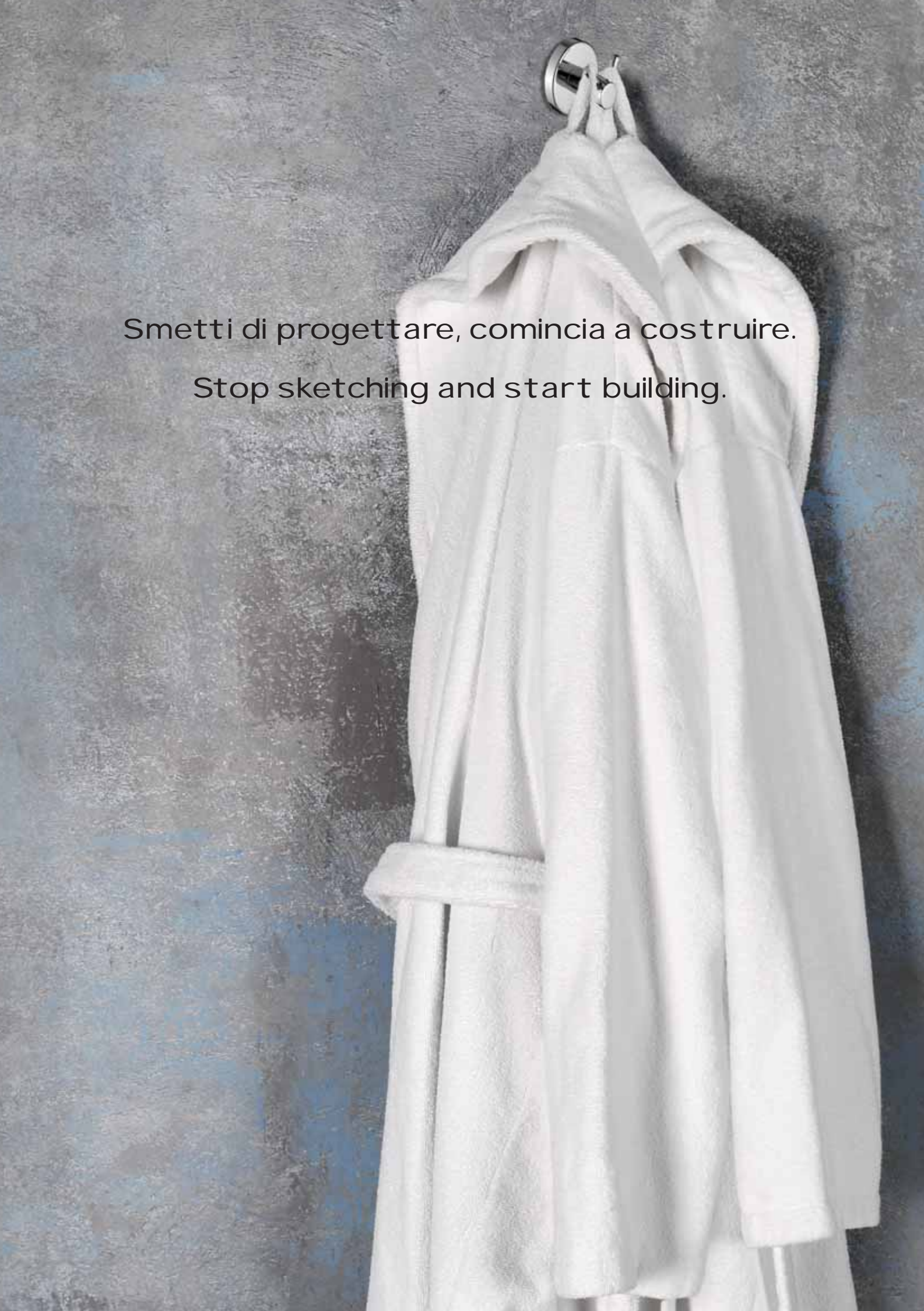

A white bathrobe is hanging from a silver metal hook on a textured, grey wall. The robe is folded at the top, and its long sleeves and body hang down. The background wall has a mottled, painterly texture with some blue and grey tones.

Smetti di progettare, comincia a costruire.

Stop sketching and start building.



project	pagina	566
dosatori	pagina	570
asciugamani elettrici	pagina	575
asciugacapelli	pagina	578
distributori di salviette ripiegate e rotoli di carta	pagina	580
mensole porta asciugamani	pagina	586
maniglioni	pagina	588
filo stendibiancheria riavvolgibile	pagina	590
materiale di consumo	pagina	591
prima classe	pagina	592
sicura	pagina	598
fortis	pagina	607

CONTRACT





13

Lucido
Polished

Novità - New

100%
AISI 304

G•PROJECT

Realizzato in acciaio inox AISI 304 con contenitori in vetro satinato

Made of AISI 304 stainless steel with satinized glass containers

Réalisée en acier inoxydable AISI 304 avec boîtiers en verre satiné

Hergestellt aus Edelstahl AISI 304 mit Behältern aus satiniertem Glas

Realizada en acero inox AISI 304 con contenedores en cristal satinado

Изготовлено из нержавеющей стали AISI 304

с ёмкостями из матового стекла

5010

7 x 11 x 10 cm



5011

11 x 13 x 6 cm



5081

7 x 11 x 15,2 cm



5021/30

30 x 8 x 5,3 cm



5021/45

45 x 8 x 5,3 cm



5021/60

60 x 8 x 5,3 cm



5070

16 x 6 x 18 cm





13

Lucido
Polished

Novità - New

100%
AISI 304

G•PROJECT

5027

5,3 x 6 x 5,3 cm



5035

50 x 25 x 16,5 cm



5026

5,3 x 6 x 5,3 cm



5025

12,3 x 8,8 x 6,7 cm



5033

16 x 12,5 x 37 cm



5024

17,7 x 7,3 x 5,3 cm



5024-02

6 x 7,3 x 17,7 cm



Dosatori

Soap dispensers - Distributeurs de savon - Seifenspender
 Dosificadores de jabon - Ёмкость для жидкого мыла

A681 G•MALDIVE

7 x 8,6 x 23,8 cm - 200 ml



A682 G•MALDIVE

5,5 x 7,1 x 21,6 cm - 350 ml



Realizzati in ottone, Cromall®/Tritan™
 Made of brass, Cromall®/Tritan™
 Réalisées en laiton, Cromall®/Tritan™
 Hergestellt aus Messing, Cromall®/Tritan™
 Realizados en latón, Cromall®/Tritan™
 Изготовлено из латуни, Cromall®/Tritan™

13

Cromato
Chromed



2086 G•KYRON

150 ml. - 5 x 10 x 17,1 cm



Realizzati in ottone
 Made of brass
 Réalisés en laiton
 Hergestellt aus Messing
 Realizados en latón
 Изготовлено из латуни

13

Cromato
Chromed

2087 G•KUBIX

1200 ml. - 10 x 11 x 32 cm



Realizzato in acciaio inox e resine termoplastiche
 Made of stainless steel and thermoplastic resins
 Réalisé en acier inoxydable et thermoplastique
 Hergestellt aus Edelstahl und Kunststoff
 Realizado en acero inox y resinas termoplásticas
 Изготовлено из нержавеющей стали и термопластичных смол



13

Lucido
Polished

2081 G•EPOS

800 ml - 11,5 x 10,5 x 18 cm

**2082 G•EPOS**

1200 ml. - cm. 12,7 x 10,5 x 20,3 cm



Realizzati in acciaio inox
 Made of stainless steel
 Réalisés en acier inoxydable
 Hergestellt aus Edelstahl
 Realizados en acero inox
 Изготовлено
 из нержавеющей стали

21

Lucido/
satinato
Polished/
satinized

2075 G•WHALE

400 ml - 12 x 11 x 15,2 cm

**2076 G•WHALE**

1000 ml - 13 x 11 x 22 cm



Realizzato in acciaio inox e ABS
 Made of stainless steel and ABS
 Réalisé en acier inoxydable et ABS
 Hergestellt aus Edelstahl und ABS
 Realizado en acero inox y ABS
 Изготовлено из нержавеющей стали и ABS

38

Spazzolato
Brushed

2090 G•FEEL

500 ml. - 11 x 10,5 x 22,2 cm



Realizzato in resine termoplastiche
 Made of thermoplastic resins
 Réalisé en thermoplastique
 Hergestellt aus Kunststoff
 Realizado en resinas termoplásticas
 Изготовлено из термопластичных смол

CON FOTOCCELLULA - WITH PHOTOCCELL
 AVEC DETECTEUR - DE MOUVEMENT
 SEIFENSPENDER MIT LICHTSCHRANKE
 CON FOTOCÉLULA - С ФОТОЭЛЕМЕНТОМ

02

Bianco
White

4xAA non include - not included



2088 G•TOUCH

500 ml. - 10,1 x 9,3 x 20,9 cm

**2089 G•TOUCH**

1000 ml. - 11 x 10,5 x 27,5 cm

**Realizzati in resine termoplastiche**

Made of thermoplastic resins

Réalisés en thermoplastique

Hergestellt aus Kunststoff

Realizados en resinas termoplásticas

Изготовлено из термопластичных смол

02Bianco
White**2096 G•SHARK**

700 ml - 8,5 x 12 x 21 cm

**Distributore di sapone in schiuma**

Foam soap dispenser

Distributeur de savon en mousse

Schaumseifenspender

Dosificador de jabon en espuma

Schuimzeepdispenser

Диспенсер пенистого мыла

Realizzato in resine termoplastiche

Made of thermoplastic resins

Réalisé en thermoplastique

Hergestellt aus Kunststoff

Realizado en resinas termoplásticas

Изготовлено из термопластичных смол

02Bianco
White**13**Cromato
Chromed**Biadesivo incluso**Adhesive included - Ruban adhésif fourni - Doppelklebeband
inklusive - Cinta adhesiva incluida - Двусторонняя клейкая
лента включена**2681 G•RALLY**

1000 ml. - 10 x 11 x 20 cm

**Realizzato in resine termoplastiche**

Made of thermoplastic resins

Réalisé en thermoplastique

Hergestellt aus Kunststoff

Realizado en resinas termoplásticas

Изготовлено из термопластичных смол

02Bianco
White**13**Cromato
Chromed

2280 G•PUSH Design: Makio Hasuike

600 ml. - 11 x 9 x 20,8 cm



100%
made in Italy

02Bianco
White

Realizzato in resine termoplastiche
Made of thermoplastic resins
Réalisé en thermoplastique
Hergestellt aus Kunststoff
Realizado en resinas termoplásticas
Изготовлено из термопластических смол

2097 G•COD

500 ml - 10,4 x 9,5 x 16,3 cm

**13**Cromato
Chromed

Realizzato in resine termoplastiche
Made of thermoplastic resins
Réalisé en thermoplastique
Hergestellt aus Kunststoff
Realizado en resinas termoplásticas
Изготовлено из термопластических смол

2093 G•TORPEDO

300 ml - 9 x 8,6 x 16 cm

**02**Bianco
White**13**Cromato
Chromed**2094 G•TORPEDO**

600 ml - 11 x 9,5 x 19,5 cm

**02**Bianco
White**Resine termoplastiche**

Thermoplastic resins
Thermoplastique
Metall und Kunststoff
Metal y resinas termoplásticas
Металл и термопластичные смолы

2091 G•MARLIN

300 ml - 5 x 11 x 14 cm

**Realizzati in resine termoplastiche**

Made of thermoplastic resins
Réalisés en thermoplastique
Hergestellt aus Kunststoff
Realizados en resinas termoplásticas
Изготовлено из термопластичных смол

02Bianco
White**13**Cromato
Chromed

2092 G•SNAPPER

450 ml - 10 x 8 x 16,4 cm



Realizzato in resine termoplastiche

Made of thermoplastic resins

Réalisé en thermoplastique

Hergestellt aus Kunststoff

Realizado en resinas termoplásticas

Изготовлено из термопластичных смол

02

Bianco
White

2084

340 ml - 5,7 x 11,5 x 25,5 cm



Dosatore da incasso per top lavabo

Built-in dispenser for washbasin top

Distributeur à encastrer pour dessus lavabo

Einbau-Seifenspender für Waschbecken-Top

Dosificador empotrado para top lavabo

Встраиваемый дозатор для умывальника

Ottone e resine termoplastiche

Brass and thermoplastic resins - Laiton et thermoplastique

Messing und Kunststoff - Latón y resinas termoplásticas

Латунь и термопластичные смолы

13

Cromato
Chromed

Asciugamani elettrici

Air hand dryer - Sèche-mains - Händetrockner - Secador de manos - Электрическая сушилка

100%
made in Italy



Novità - New

G•DIABLO



2453

29,6 x 17,7 x 56,6 cm

Asciugamani elettrico a fotocellula Eco-Jet ad inserimento verticale delle mani

Photocell electronic hand-dryer with photocell for vertical insertion of hands
Sèche-mains électrique à cellule photoélectrique Eco-Jet à introduction des mains verticale - Elektrischer Händetrockner mit Öko-Jet-Fotozelle und vertikaler Handeinführung - Secador de manos eléctrico con fotocélula Eco-Jet con introducción vertical de las manos

02

Bianco
White

08

Grigio
Grey



ABS - АБС пластик

CE 1450 W - 220-240 V
50-60 Hz - IP31



Novità - New

G•BORA

2454

22,1 x 15,7 x 28,5 cm



Asciugamani elettrico a fotocellula Eco-Jet
Eco Jet electric hand dryer with photocell

Sèche-mains électrique à cellule photoélectrique Eco-Jet

Elektrischer Händetrockner mit Öko-Jet-Fotozelle
Secador de manos eléctrico con fotocélula Eco-Jet

Elektrische handdrogers met Eco-Jet fotocel

Электрическая сушилка для рук с фотоэлементом

02

Bianco
White

13

Cromato
Chromed

85

Antracite
satinato
Anthracite
satinized

Acciaio inox AISI 304

Stainless steel AISI 304

Acier inoxydable AISI 304

Edelstahl AISI 304

Нержавеющая сталь AISI 304

CE 1100 W - 220-240 V
50-60 Hz - IP20

100%
made in Italy



Novità - New

G•ALIZÉ

2455

15,6 x 9,9 x 23,8 cm



Asciugamani elettrico a fotocellula
Eco-Jet

Eco Jet electric hand dryer
with photocell

Sèche-mains électrique à cellule photoélectrique Eco-Jet

Elektrischer Händetrockner mit Öko-Jet-Fotozelle

Secador de manos eléctrico con fotocélula Eco-Jet

Elektrische handdrogers met Eco-Jet fotocel

Električno sušilo za ruke na fotočelije Eco-Jet

02

Bianco
White

13

Cromato
lucido
Chromed

21

Satinato
Satinized

14

Nero
Black

ABS - АБС пластик

CE 900 W - 220-240 V
50-60 Hz - IP23

100%
made in Italy

G•BRISA

Novità - New

2456

26,2 x 16,5 x 30,5 cm



Asciugamani con motore ad induzione con fotocellula

Towel with induction motor and photocell
Sèche-mains à moteur à induction à cellule photoélectrique

Händetrockner mit Induktionsmotor und Fozozelle

Secador de manos con motor de inducción con fotocélula

Сушилка для рук с индукционным двигателем и фотоэлементом

02

Bianco
White

13

Cromato
Lucido
Chromed

ABS - АБС пластик

100%
made in Italy



2451

28,4 x 24,8 x 20,2 cm



02

Bianco
White

Asciugamani antivandalo ad aria calda con pulsante

Vandal-proof hot air hand dryer with pushbutton action

Sèche-mains anti-vandalisme à air chaud avec bouton

Bruchsicherer Heissluft-Händetrockner mit Taste

Secador de aire caliente para las manos resistente al vandalismo con pulsador

Сушилка для рук с защитой от вандалов, с горячим воздухом и кнопкой

Acciaio porcellanato

Vitreous enamel steel - Acier émaillé - Emaille - Acero porcelanizado

Сталь, обработанная под фарфор



W 2400 - IPX1

Asciugacapelli

Hair dryer - Sèche cheveux - Haartrockner - Secador para el cabello - Фен

G•GRECALE SHAVER

5054

11 x 31,5 x 36,5 cm



Asciugacapelli con presa rasoio

Hair dryer with electrical socket for shavers
Sèche cheveux avec prise pour les rasoirs
Haartrockner mit Steckdose für Rasierapparaten
Secador de pelo com toma de corrente para maquinillas de afeitar
Фен с розеткой для электробритов

Resine termoplastiche/acciaio inox

Thermoplastic resins/stainless steel
Thermoplastique/acier inoxydable
Kunststoff/Edelstahl
Resinas termoplásticas/acero inox
Термопластическая смола/
нержавеющая сталь

CE □ W 1300 - IP23



Nero/
Cromato
Black/
Chromed

G•ZEFIRO

5053

9 x 15 x 33 cm



Asciugacapelli

Hair dryer - Sèche cheveux
Haartrockner
Secador de pelo - Фен

Resine termoplastiche

Thermoplastic resins
Thermoplastique
Kunststoff
Resinas termoplásticas
Термопластические смолы

CE □ W 1200 - IP23



Bianco
White

G•ALBATROS

5052

9,5 x 23 x 15,7 cm

Design: Antonio Rossari



Asciugacapelli con supporto a parete

Hair dryer with wall support

Sèche cheveux avec support mural

Haartrockner mit Wandhalter

Secador para el cabello con soporte - Фен

02

Bianco
White

Resine termoplastiche

Thermoplastic resins - Thermoplastique

Metall und Kunststoff

Metal y resinas termoplásticas

Металл и термопластичные смолы

CE □ W 1200 - IP20

G•LEVANTE

5057

27 x 14,5 x 19 cm

Novità - New



Asciugacapelli 1650 W

Hair dryer 1650 W

Sèche cheveux 1650 W

Haartrockner 1650 W

Secador de pelo 1650 W

Фен 1650 W

02

Bianco
White

ABS - АБС пластик

G•MAESTRALE

5058

25 x 14 x 22 cm

Novità - New



Asciugacapelli 1800 W

Hair dryer 1800 W

Sèche cheveux 1800 W

Haartrockner 1800 W

Secador de pelo 1800 W

Фен 1800 W

02

Bianco
White

ABS - АБС пластик

Distributori di salviette ripiegate e rotoli di carta

Tissue and rollpaper dispenser - Distributeur serviettes et papier à rouleau
Tuchspender und Rollenpapierspender - Dispensador de toallas y do rolo de papel
Ёмкость для бумажных салфеток и ёмкость для туалетной бумаги

2436

28 x 10 x 36,5 cm



Distributore salviette carta - max 400 fogli

Tissue dispenser - max 400 tissues
Distributeur serviettes - max 400 serviettes
Tuchspender - max 400 Tücher
Dispensador de toallas - max 400 toallas
Ёмкость для бумажных салфеток.
максимальные 400 тканей

Acciaio inox AISI 304

Stainless steel AISI 304
Acier inoxydabile AISI 304
Edelstahl AISI 304
Нержавеющая сталь AISI 304

13

Lucido
Polished

2444

26,2 x 9 x 33 cm



max 400 fogli

max 400 tissues
max 400 serviettes
max 400 Tücher
max 400 toallas
максимальные 400 тканей

Acciaio inox AISI 304

Stainless steel AISI 304 - Acier inoxidable AISI 304
Edelstahl AISI 304 - Acero inox AISI 304
Нержавеющая сталь AISI 304

38

Acciaio
Spazzolato
Brushed
steel

2427

28 x 14 x 40 cm



02

Bianco
White100%
made in Italy**Distributore di salviette di carta piegate**

Dispenser for papersheets - Distributeur serviettes en feuille
Tuchspender für Einzelblätter - Dispensador de toallitas
Ёмкость для бумажных салфеток

Resine termoplastiche

Thermoplastic resins - Thermoplastique - Kunststoff
Resinas termoplásticas - Термопластичные смолы

Ricambio salviette ripiegate art. 2151

Folded towels refill art. 2151 - Pièce de recharge petites serviettes pliées art. 2151 - Nachfüllungsteil gefaltete kleine Tücher art. 2151
Pieza de recarga toallitas dobladas art. 2151 - Сложенные салфетки 2151

2437

17,8 x 18 x 31,8 cm - max ø 16



02

Bianco
White100%
made in Italy**Distributore di carta asciugamani a spirale**

Spiral paper hand towel dispenser
Distributeur de papier essuie-mains en spirale
Handtuchrollen-Spender
Dispensador de toallitas para secar las manos en espiral
Спиральный диспенсер бумаги для рук

Resine termoplastiche

Thermoplastic resins - Thermoplastique
Kunststoff - Resinas termoplásticas - Термопластичные смолы

2426

28 x 18 x 25 cm - max ø 15



02

Bianco
White100%
made in Italy**Distributore salviette di carta piegate o a rotolo**

Dispenser for papersheets or paper-rolls - Distributeur papier en feuilles ou en rouleau - Papierspender für Einzelblätter oder Rollen- Dispensador de toallitas o de papel en rollo - Ёмкость для салфеток или рулона

Resine termoplastiche

Thermoplastic resins - Thermoplastique - Kunststoff
Resinas termoplásticas - Термопластичные смолы

Ricambio salviette ripiegate art. 2154

Folded towels refill art. 2154 - Pièce de recharge petites serviettes pliées art. 2154 - Nachfüllungsteil gefaltete kleine Tücher art. 2154
Pieza de recarga toallitas dobladas art. 2154 - Сложенные салфетки 2154

2442

27,2 x 11 x 28,8 cm



02

Bianco
White

11

Azzurro
Light blue**max 300 fogli**

max 300 tissues - max 300 serviettes - max 300 Tücher
max 300 toallas - максимальные 300 тканей

Resine termoplastiche

Thermoplastic resins - Thermoplastique
Kunststoff - Resinas termoplásticas - Термопластичные смолы

2440

26,5 x 11 x 29 cm



11

Azzurro
Light blue

85

Antracite
Anthracite

max 200 fogli - max 200 tissues - max 200 serviettes - max 200
Tücher - max 200 toallas - максимальные 200 тканей

Resine termoplastiche

Thermoplastic resins - Thermoplastique- Kunststoff - Resinas
termoplásticas - Термопластичные смолы

2424

31 x 12,5 x 32 cm - Max ø 31 cm



13

Lucido
Polished**Distributore di carta a rotoli**

Rollpaper dispenser

Distributeur papier à rouleau

Rollenpapierspender - Dispensador rollos de papel

Ёмкость для туалетной бумаги

Acciaio inox AISI 304

AISI 304 stainless steel - acier inoxydable AISI 304

Edelstahl AISI 304 - acero inox AISI 304

нержавеющая сталь AISI 304

2445

27,8 x 13 x 28,5 cm - Max ø 27,5



38

Acciaio
spazzolato
Brushed steel**Acciaio inox AISI 304**

Stainless steel AISI 304

Acier inoxydable AISI 304

Edelstahl AISI 304

Acero inox AISI 304

Нержавеющая сталь AISI 304

2446

ø 27,8 x 13 x 28,5 - Max ø 27,5 cm

Novità - New



13

Lucido
Polished**Distributore di carta a rotoli**

Rollpaper dispenser

Distributeur papier à rouleau

Rollenpapierspender - Dispensador rollos de papel

Ёмкость для туалетной бумаги

Acciaio inox AISI 304

AISI 304 stainless steel - acier inoxydable AISI 304

Edelstahl AISI 304 - acero inox AISI 304

нержавеющая сталь AISI 304

2429 G • JUMBO MAXI

37,5 x 13,5 x 36 cm - Max ø 34

**02**Bianco
White100%
made in Italy
**Distributore di carta a rotoli**

Rollpaper dispenser
 Distributeur papier à rouleau
 Rollenpapierspender
 Dispensador rollos de papel
 Ёмкость для туалетной бумаги

Resine termoplastiche

Thermoplastic resins - Thermoplastique
 Kunststoff - Resinas termoplásticas
 Термопластичные смолы

2428 G • JUMBO MINI

27 x 12 x 25,5 cm - Max ø 24,5

**02**Bianco
White100%
made in Italy
**Distributore di carta a rotoli**

Rollpaper dispenser
 Distributeur papier à rouleau
 Rollenpapierspender
 Dispensador rollos de papel
 Ёмкость для туалетной бумаги

Resine termoplastiche

Thermoplastic resins - Thermoplastique
 Kunststoff - Resinas termoplásticas
 Термопластичные смолы

2443

26 x 12,6 x 27 cm - Max ø 22

**02**Bianco
White**11**Azzurro
Light blue**Distributore di carta a rotoli**

Rollpaper dispenser - Distributeur papier à rouleau
 Rollenpapierspender - Dispensador rollos de papel
 Ёмкость для туалетной бумаги

Resine termoplastiche

Thermoplastic resins - Thermoplastique - Kunststoff - Resinas
 termoplásticas - Термопластичные смолы

2441

21,3 x 12,2 x 24,5 cm - Max ø 19

**85**Antracite
Anthracite**Distributore di carta a rotoli**

Rollpaper dispenser - Distributeur papier à rouleau
 Rollenpapierspender - Dispensador rollos de papel
 Ёмкость для туалетной бумаги

Resine termoplastiche

Thermoplastic resins - Thermoplastique - Kunststoff
 Resinas termoplásticas - Термопластичные смолы

2339

26 x 10 x 10,6 cm

Novità - New

13
Lucido
Polished

Portarotolo doppio coperto con piano d'appoggio
 Double toilet paper holder with support stand
 Porte rouleau papier WC couvert
 Doppelte Rollenhalterung, abgedeckt durch Auflagefläche
 Portarrollos doble cubierto con superficie de apoyo
 Стойка с двойным закрытым держателем рулона

Acciaio inox AISI 304
 Stainless steel AISI 304 - Acier inoxydable AISI 304
 Edelstahl AISI 304 - Acero inox AISI 304
 Нержавеющая сталь AISI 304

2525

12 x 14,2 x 7,2 cm

13
Cromato
Chromed

Portarotolo coperto
 Paper holder with cover
 Porte rouleau avec couvercle
 Papierrollenhalter mit Deckel
 Portarrollo con tapa
 Бумагодержатель с крышкой

Acciaio inox/ Cromall®
 Stainless steel/ Cromall®
 Acier inoxydable/Cromall®
 Edelstahl/Cromall®
 Acero inox/Cromall®
 Нержавеющая сталь/Cromall®

2439

14 x 13,5 x 15 cm

02
Bianco
White

100%
made in Italy

Distributore di carta igienica a rotoli o intercalata
 Toilet paper dispenser for rolls or squares
 Distributeur papier toilette en rouleau ou feuille a feuille
 Toilettenpapierspender für rolle oder Einzelblatt
 Dispensador papel higiénico en rollos o en hojas
 Дисенсер туалетной бумаги рулонный и листовой

Resine termoplastiche
 Thermoplastic resins - Thermoplastique
 Kunststoff - Resinas termoplásticas
 Термопластичные смолы

2308

25,4 x 7,6 x 13,1 cm

13
Lucido
Polished

Porta fazzoletti
 Tissue box
 Boîte à mouchoirs
 Tücherbehälter
 Porta pañuelos
 Ёмкость для салфеток

Acciaio inox AISI 304
 Stainless steel AISI 304 - Acier inoxydable AISI 304
 Edelstahl AISI 304 - Acero inox AISI 304
 Нержавеющая сталь AISI 304

2002

13,4 x 13,4 x 13 cm

Novità - New



13

Lucido
Chromed**Porta fazzoletti**

Tissue box
Boîte à mouchoirs
Tücherbehälter
Porta pañuelos
Ёмкость для салфеток

Acciaio inox AISI 304

Stainless steel AISI 304 - Acier inoxydable AISI 304
Edelstahl AISI 304 - Acero inox AISI 304
Нержавеющая сталь AISI 304

2008

25,8 x 13,2 x 6,3 cm

Design: Makio Hasuike

02

Bianco
White

13

Lucido
Chromed**Porta fazzoletti**

Tissue box
Boîte à mouchoirs
Tücherbehälter
Porta pañuelos
Ёмкость для салфеток

**Resine termoplastiche**

Thermoplastic resins - Thermoplastique
Kunststoff - Resinas termoplásticas
Термопластичные смолы

100%
made in Italy



2330

13,4 x 26 x 9 cm

Novità - New



13

Lucido
Polished**Porta sacchetti igienici**

Holder for sanitary towel bags - Porte-sachets hygiéniques
Behälter für Hygienebeutel - Porta-bolsitas higiénicas
Урна для гигиенических прокладок

Acciaio inox AISI 304

Stainless steel AISI 304 - Acier inoxydable AISI 304
Edelstahl AISI 304 - Acero inox AISI 304
Нержавеющая сталь AISI 304

2430

9,8 x 3,8 x 13,5 cm

02

Bianco
White

13

Lucido
Polished**Porta sacchetti igienici**

Holder for sanitary towel bags - Porte-sachets hygiéniques
Behälter für Hygienebeutel - Porta-bolsitas higiénicas
Урна для гигиенических прокладок

Fissaggio con biadesivo o viti - resine termoplastiche

Biadhesive or screw fixing - thermoplastic resins - Applicable avec biadhésif ou vis - thermoplastique - Mit doppelseitiger Klebstreifen oder Schrauben aufhängbar - Kunststoff - Aplicabile con biadesivo o tornillos - resinas termoplásticas - крепление винтами или двусторонней липкой лентой термопластичная смола

100%
made in Italy



Mensole porta asciugamani

Shelves for towels - Etagères porte serviette - Handtuchablage
Estantes para toallas - Держатель полотенца

13

Cromato
Chromed

A235 G•CANARIE

62 x 25 x 14,5 cm

Ottone/Cromall®

Brass/Cromall® - Laiton/Cromall®
Messing/Cromall® - Latón/Cromall®
Латунь/ Cromall®



3235 G•OUTLINE

Design: Simone Micheli

50 x 26 x 14 cm

Acciaio inox/Ottone/Cromall®

Stainless steel/Brass/Cromall® - Acier inoxydable/Laiton/Cromall®
Edelstahl/Messing/Cromall® - Acero inox/Latón/Cromall®
Нержавеющая сталь/Латунь/ Cromall®

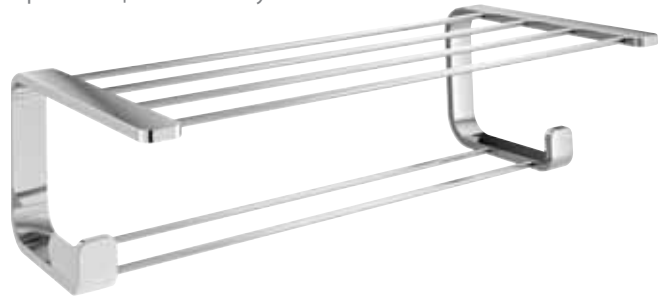

5335 G•FEBO

52,4 x 25,2 x 12 cm

Acciaio inox/Cromall®

Stainless steel/Cromall® - Acier inoxydable/Cromall®
Edelstahl/Cromall® - Acero inox/Cromall®
Нержавеющая сталь/ Cromall®



5344 G•FEBO

52,4 x 25,2 x 7 cm

Acciaio inox/Cromall®

Stainless steel/Cromall® - Acier inoxydable/Cromall®
Edelstahl/Cromall® - Acero inox/Cromall®
Нержавеющая сталь/ Cromall®



5035 G•PROJECT

50 x 25 x 16,5 cm

Acciaio inox AISI 304

Stainless steel AISI 304 - Acier inoxydable AISI 304
Edelstahl AISI 304 - Acero inox AISI 304
Нержавеющая сталь AISI 304

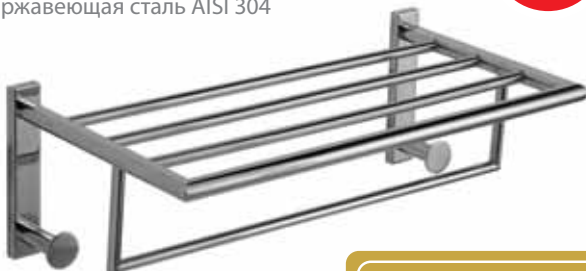
100%
AISI 304

Novità - New

2435 G•ASCOT

Design: Carlo Vietri

59,8 x 30,1 x 15,9 cm

Acciaio inox/Cromall®

Stainless steel/Cromall® - Acier inoxydable/Cromall®
Edelstahl/Cromall® - Acero inox/Cromall®
Нержавеющая сталь/ Cromall®

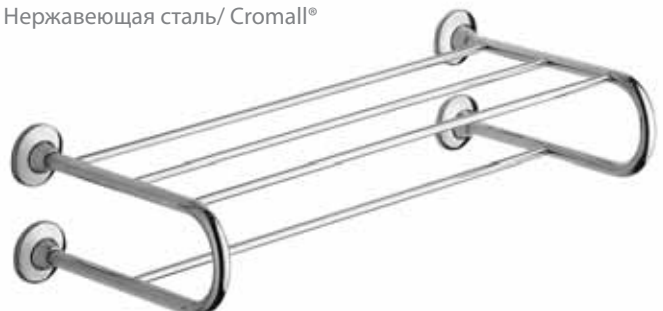

2735 G•ASCOT

Design: Carlo Vietri

60,4 x 30,4 x 12 cm

Acciaio inox/Cromall®Stainless steel/Cromall® - Acier inoxydable/Cromall®
Edelstahl/Cromall® - Acero inox/Cromall®
Нержавеющая сталь/ Cromall®**2744 G•ASCOT**

Design: Carlo Vietri

60,4 x 30,4 x 5,9 cm

Acciaio inox/Cromall®Stainless steel/Cromall® - Acier inoxydable/Cromall®
Edelstahl/Cromall® - Acero inox/Cromall®
Нержавеющая сталь/ Cromall®**ED35 G•EDERA**

62,4 x 25,3 x 11,2 cm

Acciaio inox/Cromall®Stainless steel/Cromall® - Acier inoxydable/Cromall®
Edelstahl/Cromall® - Acero inox/Cromall®
Нержавеющая сталь/ Cromall®**ED44 G•EDERA**

62,4 x 25,3 x 5 cm

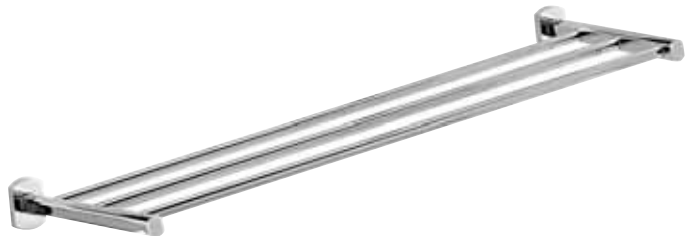
Acciaio inox/Cromall®Stainless steel/Cromall® - Acier inoxydable/Cromall®
Edelstahl/Cromall® - Acero inox/Cromall®
Нержавеющая сталь/ Cromall®**FE35 G•FELCE**

61,5 x 26,2 x 14,4 cm

Acciaio/Cromall®Steel/Cromall® - Acier/Cromall®
Stahl/Cromall® - Acero/Cromall®
сталь/ Cromall®**FE44 G•FELCE**

61,5 x 26,2 x 5,6 cm

Acciaio/Cromall®Steel/Cromall® - Acier/Cromall®
Stahl/Cromall® - Acero/Cromall®
сталь/ Cromall®

Maniglione G•Maldive

Realizzata in ottone e Cromall®
 Made of brass and Cromall®
 Réalisée en laiton et Cromall®
 Hergestellt aus Messing und Cromall®
 Realizada en latón et Cromall®
 Изготовлено из латуни и Cromall®

13

Cromato
Chromed

A621-38

38 x 6,5 x 3 cm



A621-50

50 x 6,5 x 3 cm



A621-65

65 x 6,5 x 3 cm



A622

56 x 6,5 x 22,8 cm

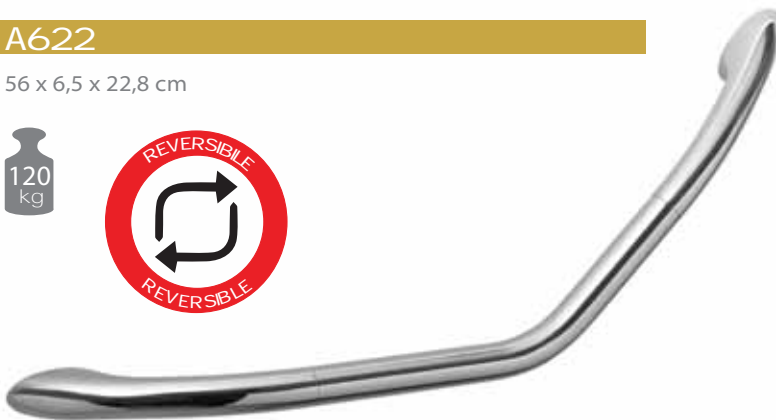

Maniglioni G•Ascot

Maniglioni realizzati in acciaio inox , alluminio e Cromall®
 Grab bars made of stainless steel, aluminum and Cromall®
 Barres d'appui réalisées en acier inox, aluminium et Cromall®
 Wannengriffe hergestellt aus Edelstahl, Aluminium und Cromall®
 Asideros realizados en acero inox, aluminio y Cromall®
 Поручень изготовлено из сталь, алюминия и Cromall®

Design: Carlo Vietri



13

ø 25 - sp.1 Cromato Chromed

2721 / 28

28,7 x 9,6 x 7,2 cm



2721 / 37

37,2 x 9,6 x 7,2 cm



2721 / 67

67,2 x 9,6 x 7,2 cm



2722

48,5 x 9,6 x 24,3 cm

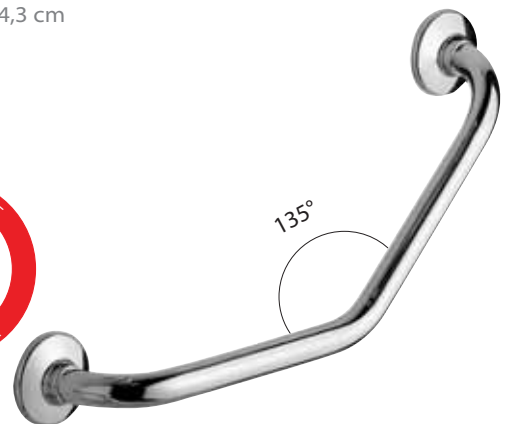

2720

48,5 x 13 x 24,3 cm



con portasapone in filo reversibile in acciaio inox
 with reversible wire soap holder in stainless steel
 avec porte savon fil réversible en acier inoxydable
 mit umkehrbarer Stabseifenschale aus Edelstahl
 con jabonera de varillas móvil en acero inox
 с мьльницей с проволочным основанием
 ие нержавеющей стали

Maniglioni G•Edera

Maniglioni realizzati in acciaio inox e Cromall® - Grab bars made of stainless steel and Cromall®
 Barres d'appui réalisées en acier inox et Cromall® - Wannengriffe hergestellt aus Edelstahl und Cromall®
 Asideros realizados en acero inox y Cromall® - Поручень изготовлено из сталь и Cromall®

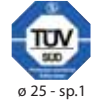

13
 Cromato
 Chromed

ED21/28

26,9 x 9,6 x 8 cm

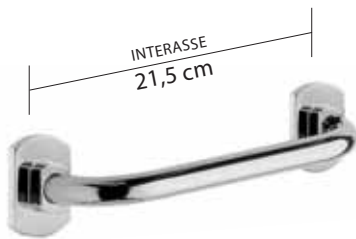

ED21/37

35,4 x 9,6 x 8 cm

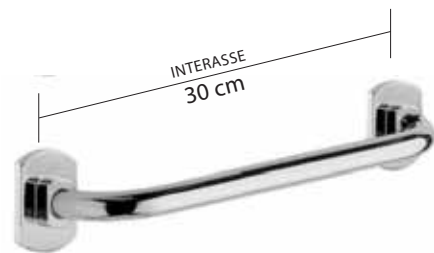

ED22

46,8 x 9,6 x 25,2 cm

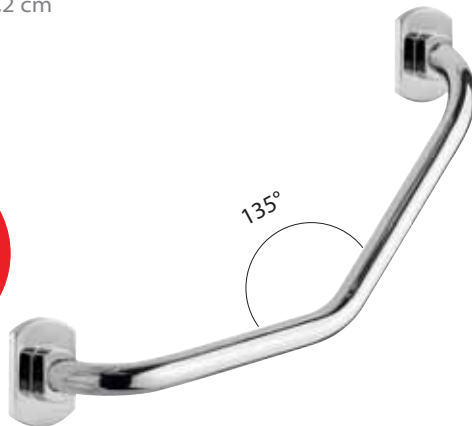

ED20

46,8 x 13 x 25,2 cm

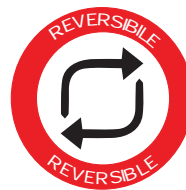

con portasapone in filo reversibile in acciaio inox
 with reversible wire soap holder in stainless steel
 avec porte savon fil réversible en acier inoxydable
 mit umkehrbarer Stabseifenschale aus Edelstahl
 con jabonera de varillas móvil en acero inox
 с мыльницей с проволочным основанием из нержавеющей стали

Filo stendibiancheria riavvolgibile

Retractable clothes line - Sèche linge retractable - Aufrollbarer Wäschetrockner - Tendedero enrollable ocultador
 Выдвижная нить для сушки белья

2450 G•TULLO

∅ 9 x 6 cm

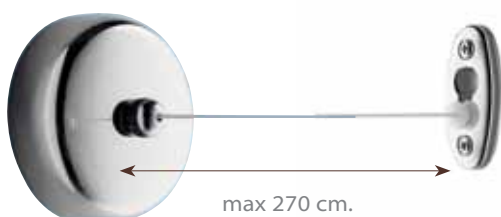

Acciaio inox
 Stainless steel
 Acier inoxydable
 Acier inoxydable
 Edelstahl
 Acero inox
 нержавеющая сталь

13
 Lucido
 Polished

Materiale di consumo

Contract-sector range: refills - Collection pour hôtels et communautes: pièces de recharge
 Contract-Sektor Sortiment: Nachfüllungsteile - Gama para hoteles y comunidades: piezas de recarga
 Гамма для отелей: заполнение

100%
made in Italy

00

* 100% pura cellulosa - 100% pure cellulose - 100% pure cellulose
 100% reine Zellulose - 100% celulosa pura - целлюлоза 100% чисто

2150

8,8 x 12 x 2,5 cm



Sacchetti igienici in plastica

Plastic hygienic bags

Sachets hygiéniques en plastique

Abfallbeutel aus Kunststoff

Bolsitas higiénicas en plástica

Гигиенические пакеты

6 conf. da 25 pz.
 6 boxes of 25 pcs/each
 6 conf.de 25 pièces/chaque
 6 Boxen von 25 St./jds
 6 confecciones de 25 piezas/cada
 6 коробок 25 частей

2151 *

23 x 9,5 x 11 cm



Salviettine piegate a C - conf. da 150 pz.

Folded towels - box of 150 pcs

Petites serviettes pliées - confection de 150 pièces

Gefaltete kleine Tücher - Box von 150 St.

Toallitas dobladas - confección de 150 piezas

Сложенные салфетки - коробка 150 уастей

2152 *

ø 22 x 11,5 cm



Confezione 6 rotoli carta igienica a 2 veli per mini Jumbo m. 200 cad.

Package containing 6 rolls of toilet tissue (m.200/each)

Paquet 6 rouleaux papier hygiénique (m.200/chaque)

Packung mit 6 Rollen Toilettenpapier (m.200/jds)

Paquete 6 rollos papel higiénico (m.200/cada)

Упаковка из 6 рулонов туалетной бумаги (200 м.)

2153 *

ø 31 x 11,5 cm



Confezione 6 rotoli carta igienica a 2 veli per maxi Jumbo m. 500 cad.

Package containing 6 rolls of toilet tissue (m.500/each)

Paquet 6 rouleaux papier hygiénique (m.500/chaque)

Packung mit 6 Rollen Toilettenpapier (m.500/jds)

Paquete 6 rollos papel higiénico (m.500/cada)

Упаковка из 6 рулонов туалетной бумаги (500 м.)

2154 *

41,5 x ø13 x 21 cm



Confezione 3 rotoli carta asciugatutto - m.50 cad.

Package containing 3 rolls of paper towels (m.50/each)

Paquet 3 rouleaux papier essuie-tout (m.50/chaque)

Packung mit 3 Papierrollen (m.50/jds)

Paquete 3 rollos papel secante (m.50/cada)

Упаковка из 3 рулонов абсорбирующей бумаги (50 м.)

2156 *

33 x 11,6 x 9,7 cm



Confezione 3 mazzette da 300 fogli carta igienica intercalata

Package of 3 bundles of 300 sheets of toilet paper squares

Confection 3 lots de 300 feuilles papier toilette feuille a feuille

3er-packung mit 300 einzelblättern toilettenpapier

Paquete 3 juegos de 300 hojas de papel higiénico

Упаковка из 3 пачек по 300 листов туалетной бумаги



ø 32 mm



Cromato
Chromed

100%
made in Italy



G•PRIMA CLASSE

Programma in acciaio inox e nylon

Program made of stainless steel and nylon - Programme en acier inoxydable et nylon

Programm aus Edelstahl und Nylon - Programa en acero inox y nylon

Программа из нержавеющей стали и нилон

Un disegno aggiornato e moderno, massima funzionalità, materiali di alta qualità e un sistema modulare: questo il nuovo programma PRIMA CLASSE. Il sistema di sedute è composto da un esclusivo sedile ribaltabile per la doccia e da uno sgabello in differenti varianti di colori (bianco, cromo/bianco e cromo/grigio). Il sistema di maniglioni è realizzato in acciaio inox in finitura lucida e completato con il maniglione di sostegno e l'appoggio ribaltabile, con o senza portarotolo, dalla forma moderna e chic.

A modern up-to-date design, absolute functionality, high-quality materials and modular construction system: those are the outstanding characteristics of the new PRIMA CLASSE program of safety grab bars. The seat system is composed by an exclusive tilt-up shower seat and a bath stool in different colour variants (white, chrome/white and chrome/grey). The handles are made of stainless steel in polished finishing and rounded off by the folding and support handle, with or without paper holder, in a modern and elegant design.

Modernes zeitgemäßes Design, absolute Funktionalität, hochwertige Materialien und modulares Baukastensystem: Diese sind die herausragenden Merkmale des Sitz- und Griffsystems PRIMA CLASSE. Das Sitzprogramm setzt sich aus einem exklusiven Duschklappsitz und einem Badehocker in verschiedenen Farbvarianten (weiß, chrom/weiß und chrom/grau) zusammen. Das Griffsystem besteht aus poliertem Edelstahl und abgerundet wird dieses Programm durch den Klapp- und Stützgriff, mit oder ohne Papierrollenhalter, mit einer modernen eleganten Form.

Un diseño moderno, materiales de alta calidad, funcionalidad absoluta y modularidad: este el nuevo programa de asientos y de asideros de seguridad PRIMA CLASSE. El sistema de asientos se compone de un exclusivo asiento móvil para ducha y de un taburete en diversas variantes de color (blanco, cromo/blanco y cromo/gris). El programa de asideros es realizado en acero inoxidable en acabado brillo y es completado por el asidero móvil, con o sin portarrollo y el asidero de apoyo, de forma moderna y elegante.

Un design actuel et moderne, une extrême fonctionnalité, des matériaux de haute qualité et un système modulaire: c'est la nouvelle collection PRIMA CLASSE. Le système de sièges est composé par un exclusif siège repliable pour la douche et par un tabouret en plusieurs couleurs (blanc, chromé/blanc et chromé/gris). Le système de barres est réalisé en acier inoxydable avec finition polie et complété par la barre d'appui et par la barre à abattant, avec ou sans porte papier, de forme moderne et chic.

Современная и обновленная конструкция, максимальная функциональность, высококачественные материалы и модульная система - все это новая программа "ПЕРВЫЙ КЛАСС". Система для сидения состоит из уникального откидного сиденья для душа и табурет различных цветов (белый, хромированный/белый и хромированный/серый). Система ручек изготовлена из нержавеющей стали с блестящей отделкой, дополнена поручнем и откидной ручкой с держателем для туалетной бумаги или без него в современном и шикарном стиле



6008

60 x 12,2 x 74,5 cm

**Specchio basculante infrangibile in acciaio inox**

Shatterproof tilting mirror in stainless steel
 Miroir basculant infrangible en acier inox
 Neigbarer bruchsicherer Spiegel aus Edelstahl
 Espejo basculante irrompible de acero inoxidable
 Поворотное зеркало небьющееся из нержавеющей стали

non certificato TÜV - Not TÜV certified - non certifié TÜV
 Nicht TÜV-geprüft - no certificado TÜV
 испытания на соответствие нормативу TÜV не проводились

13

Super
Mirror

4942

23 x 13 x 7 cm



CE

IP 23

W75 - R7S

**Lampada alogena per specchio 6008
ottone/vetro/resine termoplastiche**

Lamp with halogen light for mirror 6008
 brass/glass/thermoplastic resins

Applique avec lampe halogène pour miroir 6008
 laiton/verre/thermoplastique

Leuchte mit Halogenlampe für Spiegel 6008
 Messing/Glas/Kunststoff

Aplique con lámpara para espejo 6008
 latón/cristal/résinas termoplásticas

Чниверсальная галотенная лаппа для зеркала
 6008 - латунь/стекло/термопластичная смола

6046

7,8 x 9,3 x 107,8 cm

**Sostegno per doccia con
saliscendi**

Shower support with sliding rail
 Barre pour douche avec système
 de fixation ajustable
 Duschstangenhalterung
 Soporte para ducha con columna
 Штанга для душа

6047

9,5 x 4,5 x 6 cm



08

Grigio
Grey**Saliscendi - ABS**

Shower support - ABS
 Fixation douche ajustable - ABS
 Duschhalterung - ABS
 Soporte para ducha - ABS
 Подвижный/держатель
 для душа - ABS



6021/25

A 25 cm

32,8 x 9,3 x 7,8 cm

6021/45

A 45 cm

52,8 x 9,3 x 7,8 cm

6021/55

A 55 cm

62,8 x 9,3 x 7,8 cm

6021/65

A 65 cm

72,8 x 9,3 x 7,8 cm

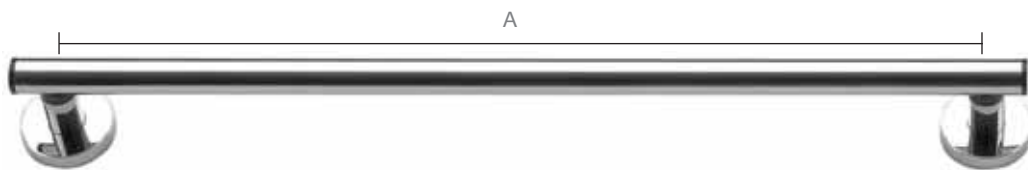
**6043/10**

112,8 x 9,3 x 7,8 cm

**6090/44**

66,5 x 9,3 x 51,5 cm

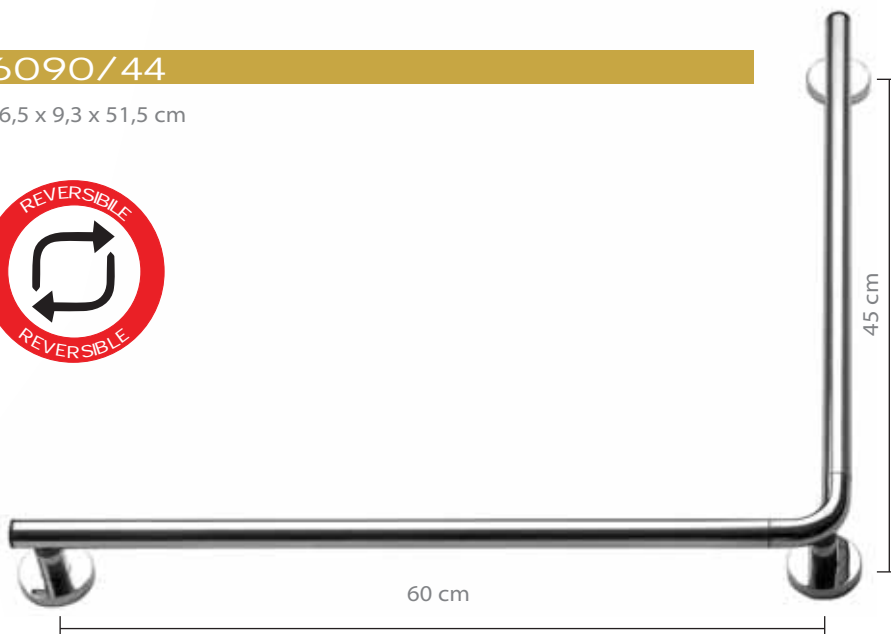

6057/65 ▲

10 x 65 x 28 cm

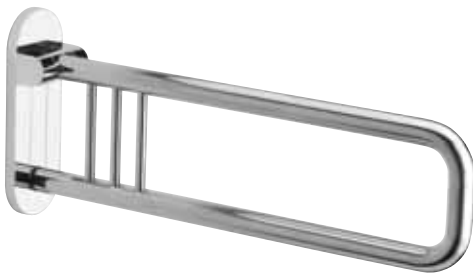
**6057/75 ▲**

10 x 75 x 28 cm

Appoggio ribaltabile

Safety folding handle - Barre à abattant

Klappgriff - Soporte móvil - Мобильный поручень

Design: Studio Talocci



- ▲ Meccanismo di ribaltamento in posizione orizzontale e verticale
- Collapsible mechanism in horizontal and vertical position
- Mécanisme de basculement en position horizontale et verticale
- Kippmechanismus in waagerechter und in senkrechter Position
- Mecanismo de abatimiento en posición horizontal y vertical
- Откидной механизм в вертикальном и горизонтальном положении

6059/65

10 x 65 x 28 cm

**Appoggio reversibile**

Reversible safety handle

Support réversible

Wandstützgriff umkehrbar

Soporte móvil - Обратимый

Design: Studio Talocci

**6058/65 ▲**

10 x 65 x 34 cm

**6058/75 ▲**

10 x 75 x 34 cm

Appoggio ribaltabile con portarotolo

Safety folding handle with paper holder - Barre à abattant avec porte

rouleau - Klappgriff mit Papierrollenhalter - Soporte móvil con portarrollo

Мобильный поручень с бумагодержателям

Design: Studio Talocci

non certificato TÜV - Not TÜV certified - non certifié TÜV

Nicht TÜV-geprüft - no certificado TÜV

испытания на соответствие нормативу TÜV не проводились

6083

35,5 x 37 x 10,5 cm

**Sedile ribaltabile per doccia - alluminio/ABS**

Shower seat - aluminium/ABS

Siège pour douche repliable - aluminium/ABS

Duschsitz hochklappbar - Aluminium/ABS

Asiento móvil para ducha - aluminio/ABS

Сиденье для душа - алюминий/ABS

Design: Studio Talocci

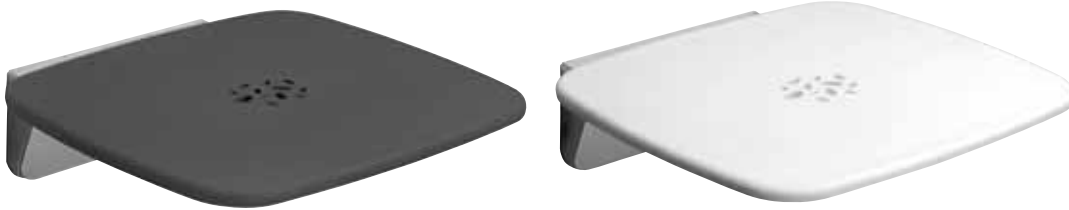
02 Bianco
White

23 Bianco/cromo
White/chromed

43 Antracite/cromo
Anthracite/chromed

— 4,8 —

non certificato TÜV - Not TÜV certified - non certifié TÜV
Nicht TÜV-geprüft - no certificado TÜV
испытания на соответствие нормативу TÜV не проводились

6072

40,9 x 33,1 x 43,8 cm

**Sgabello - alluminio/ABS**

Stool - aluminium/ABS

Tabouret - aluminium/ABS

Hoher - Aluminium/ABS

Taburete - aluminio/ABS

Табурет - алюминий/ABS

Design: Studio Talocci

02 Bianco
White

23 Bianco/cromo
White/chromed

43 Antracite/cromo
Anthracite/chromed

non certificato TÜV - Not TÜV certified - non certifié TÜV
Nicht TÜV-geprüft - no certificado TÜV
испытания на соответствие нормативу TÜV не проводились



ø 32 mm



100%
made in Italy

G•SICURA

Programma in alluminio e nylon
 Program made of aluminium and nylon
 Programme en aluminium et nylon
 Programm aus Aluminium und Nylon
 Programa en aluminio y nylon
 Програма из алюминий и нейлон

Un vastissimo programma di maniglioni e sistemi d'appoggio fissi e mobili in grado di soddisfare tutte le esigenze. Il sistema Sicura, messo a punto sulla base delle più recenti ricerche in tema di ergonomia, offre sicurezza e libertà dalle barriere architettoniche. Possibilità di inserimento nel settore della riabilitazione, casa di cura per anziani, nel campo dei sanitari, case private e strutture pubbliche. Copertura trattata con polveri speciali in resine epossidiche e poliestere, antiurto, antigraffio e non attaccabile dalle sostanze disinfettanti.

A very wide range of handles and fixed and movable supporting systems which will satisfy any requirements. The Sicura system, with designs based on the most recent research into ergonomics, offers safety and freedom from architectural barriers. Can be used in the sector of rehabilitation, residential homes for the elderly, in the sanitary-ware field, private houses and public buildings. Covering treated with special epoxy and polyester resins, shockproof, scratch-proof and resistant to attack by disinfectants.

Un très vaste éventail de poignées et de systèmes d'appui fixes et mobiles en mesure de satisfaire toutes les exigences. Le système Sicura, mis au point sur la base des plus récentes recherches en thème d'ergonomie, permet de surmonter en toute sécurité et liberté les barrières architectoniques. Possibilité de les placer dans le secteur de la rééducation, des maisons de santé pour personnes âgées, dans le domaine des sanitaires, des maisons privés et des structures publiques. Couverture traitée avec des poudres spéciales en résines époxy et polyester, antichoc, anti-égratignures et résistante aux substances désinfectantes.

Ein großes Angebot an Griffen, sowie festen und mobilen Stützsystemen, die allen Ansprüchen entsprechen. Das auf neusten ergonomischen Untersuchungen basierende Sicura System bietet Sicherheit und Unabhängigkeit von architektonischen Barrieren. Es kann für den Rehasektor, Altersheime, Sanitäreinrichtungen, Privathäuser und öffentliche Einrichtungen eingesetzt werden. Die mit Spezialpulver aus Epoxyd- und Polyesterharzen oberflächenbehandelte Serie aus Aluminium und Nylon ist schlagfest, kratzfest und gegen Desinfektionsmittel unempfindlich.

Un amplísimo programa de grilletes y de sistemas de apoyo fijos y de muebles capaces de satisfacer todas las exigencias. El sistema Sicura, puesto a punto basándose en las más recientes investigaciones en tema de ergonomía, ofrece seguridad y libertad de las barreras arquitectónicas. Posibilidad de introducción en el sector de la rehabilitación, en las clínicas para ancianos, en el campo de los sanitarios, en las casas privadas y en las estructuras públicas. Revestimiento tratado con polvos especiales de resinas epoxídicas y poliéster, antichoque, irrayable y no atacable por las sustancias desinfectantes.

Предлагаем широкий ассортимент поручней и опорных приспособлений, как съёмных, так и стационарных, отвечающих самым разнообразным требованиям. Система Sicura, разработанная с учётом последних достижений в области эргономики, обеспечивает безопасность при отсутствии капитальных ограждений. Она предназначена для использования в больничных и реабилитационных учреждениях, домах престарелых, жилых домах и помещениях общего пользования. При изготовлении используется алюминий и нейлон, а также покрытия, обработанные специальными эпоксидными и полиэфирными порошками, устойчивыми к механическим и химическим воздействиям.



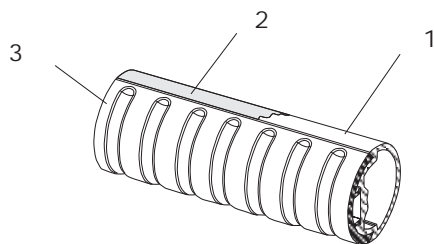

I 1 COPERTURA

- Trattata con polveri speciali in resine epossidiche e poliesteri
- Antiurto, antigraffio e non attaccabile dalle sostanze disinfettanti

2 PROFILO

- Profilo in lega speciale di alluminio-silicio-magnesio con eccellenti proprietà meccaniche
- Altissima resistenza alla corrosione, ecc.

3 NYLON

- Nylon è un termine commerciale per il poliammide. Il materiale possiede qualità tali da renderlo adatto anche per la realizzazione di componenti tecniche. Viene dunque preferito per le sue proprietà e cioè:
 - resistenza alle rotture
 - resistenza all'abrasione
 - resistenza alle alte temperature
 - resistenza ai solventi ed ai prodotti chimici

D 1 ABDECKUNG

- Mit Spezialpulver aus Epoxyharze und Polyester behandelt
- Schlagfest, kratzfest und unempfindlich gegen Desinfektionsmittel

2 PROFIL

- Profil aus Aluminium-Silizium-Magnesium-Legierung mit hervorragenden mechanischen Eigenschaften
- Extrem korrosionsfest

3 NYLON

- Nylon ist eine Handelsbezeichnung für Polyamid. Das Material besitzt Charakteristiken, die es zur Herstellung technischer Komponenten geeignet machen. Es wird wegen folgender Eigenschaften bevorzugt:
 - bruchfest
 - verschleißfest
 - temperaturunempfindlich
 - unempfindlich gegen Lösungsmittel und chemische Erzeugnisse

GB 1 COVERING

- treated with special epoxy resin and polyester powders
- shockproof, scratch-proof and resistant to disinfectants

2 PROFILE

- Profile in special aluminium-silicon-magnesium alloy with excellent mechanical properties
- very high resistance to corrosion

3 NYLON

- Nylon is a commercial term for polyamide. This material has qualities that make it suitable for producing technical components. It is therefore preferred because of its properties, i.e.:
 - resistance to breaking
 - resistance to abrasions
 - resistance to high temperatures
 - resistance to solvents and chemicals

E 1 REVESTIMIENTO

- tratado con polvos especiales de resinas epoxídicas y poliéster
- antichoque, resistente al rayado y no atacable por las sustancias desinfectantes

2 PERFIL

- Perfil de aleación especial de aluminio-silicio-magnesio con excelentes propiedades mecánicas
- altísima resistencia a la corrosión

3 NYLON

- Nylon es un término comercial para la poliamida. El material posee calidades que hacen que sea adecuado también para la realización de componentes técnicos. Por lo tanto se prefiere por sus propiedades, es decir:
 - resistencia a las rupturas
 - resistencia a la abrasión
 - resistencia a las altas temperaturas
 - resistencia a los solventes y a los productos químicos

F 1 COUVERTURE

- traité avec poudres spécifiques de résines époxydiques et polyester
- antichoc, antirayures et entièrement résistant aux produits désinfectants

2 PROFIL

- Profil en alliage spécial aluminium-silicium-magnésium offrant d'excellentes propriétés mécaniques
- très haute résistance à la corrosion

3 NYLON

- Nylon est l'appellation commerciale du polyamide. Ce matériau possède des qualités lui permettant d'être utilisé pour la réalisation des composants techniques:
 - résistance à la rupture
 - résistance à l'abrasion
 - résistance aux hautes températures
 - résistance aux solvants et aux produits chimiques

R 1 ПОКРЫТИЕ

- обработано специальными порошками из эпоксидных смол и полиэфира
- противоударное, защищенное от царапин и не повреждаемое дезинфицирующими средствами

2 ПРОФИЛЬ

- профиль из специального сплава алюминия-кремния-магния с прекрасными механическими свойствами
- высочайшая устойчивость к коррозии

3 НЕЙЛОН

- Нейлон – это коммерческий термин для обозначения полиамида. Этот материал обладает качествами, делающими его пригодным для изготовления технических компонентов. Его использование предпочтительно благодаря его свойствам:
 - устойчивость к поломкам
 - устойчивость к абразивному износу
 - устойчивость к высоким температурам
 - устойчивость к растворителям и химическим веществам

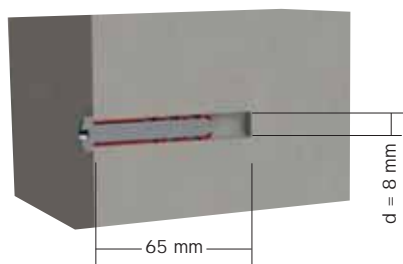

① FISSAGGIO STANDARD

I seguenti accessori, adatti per il montaggio standard, sono inclusi:

- Tassello in nylon BF 8
- Vite da legno 5,5 x 50 din 7981 - UNI 6954

adatta per calcestruzzo, mattoni pieni, mattoni forati
Per pareti non comprese nelle tipologie sopraelencate, rivolgersi ad una ditta specializzata.

Ⓞ STANDARD FIXING

The following accessories, suitable for standing mounting, are included:

- 8 - BF nylon wall plugs
- 5 - Wood screws - 5,5x50 din 7981 - UNI 6954 suitable for concrete, solid brick, hollow bricks, plasterboard

For walls not included in the types listed above, apply to a specialist company.

Ⓛ FIXATION STANDARD

Les accessoires suivants, prévus pour un montage standard, sont inclus dans la fourniture:

- cheville en nylon BF 8
- vis en bois 5,5x50 DIN 7981 - UNI 6954 prévue pour béton, briques pleines, briques perforées, placoplâtre

En ce qui concerne les types de murs non énumérés plus haut, prière de s'adresser à une entreprise spécialisée.

Ⓛ STANDARDBEFESTIGUNG

Folgende für eine Standardmontage erforderliche Komponenten sind inbegriffen:

- Nyldübel BF 8
- Holzschraube 5,5x50 DIN 7981 - UNI 6954 geeignet für Beton, Vollstein, Hohlstein, Rigips-Platten

Für oben nicht aufgeführte Wandtypen ist sich an einen Fachbetrieb zu wenden

Ⓛ FIJACIÓN ESTÁNDAR

Están incluidos los siguientes accesorios, aptos para el montaje estándar:

- taco de nylon BF 8
- tornillo de madera 5,5x50 din 7981 - UNI 6954 apto para hormigón, ladrillos llenos, ladrillos huecos, cartontabla

Para paredes no incluidas en las tipologías aquí arriba mencionadas, dirigirse a una empresa especializada

Ⓛ СТАНДАРТНАЯ ФИКСАЦИЯ

Включены следующие принадлежности, подходящие для стандартного монтажа:

- нейлоновая пробка BF 8
- винт для дерева 5,5x50 din 7981 - UNI 6954, подходящий для бетон, полнотелые кирпичи, пустотелые кирпичи, гипсокартон.

Для стен, не включенных в данные типологии, указанные выше, следует обращаться в специализированную организацию

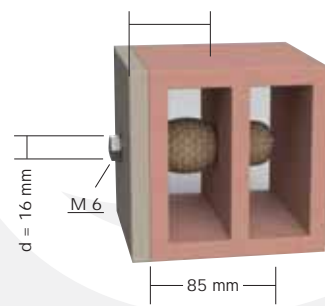

① FISSAGGIO SPECIALE

Gli accessori sottoelencati per il fissaggio speciale

- devono essere acquistati in un negozio specializzato:
- ancorante chimico ad iniezione, mod. Fischer FIP 16
- vite esagonale M 6 x 20 DIN 931 CNS

Adatto per il fissaggio alle seguenti pareti:

- mattoni forati
- mattoni in agglomerato precompresso
- mattoni pieni

Ⓞ SPECIAL FIXING

The accessories listed below must be purchased in a specialist sales outlet:

- chemical hanger for injection, mod. Fischer FIP 16
- hexagonal screws M 6x20 din 931 CNS

Suitable for fixing to the following walls:

- hollow brick
- pre-compressed briquette
- solid brick

Ⓛ FIXATION SPÉCIALE

Les accessoires ci-dessous doivent être achetés dans un magasin spécialisé :

- agent d'ancrage chimique à injection, mod. Fischer FIP 16
- vis hexagonale M 6x20 DIN 931 CNS

Prévu pour fixation aux types de murs suivants :

- briques perforées
- briques en aggloméré précontraint
- briques pleines

Ⓛ SPEZIALBEFESTIGUNG

Das unten aufgeführte Material ist im Fachhandel erhältlich:

- Injektionsverankerung, Mod. Fischer FIP 16
- Sechskantschraube M 6x20 DIN 931 CNS

Für die Befestigung an folgenden Wänden geeignet:

- Hohlstein
- Porenbeton
- Vollstein

Ⓛ FIJACIÓN ESPECIAL

Los accesorios indicados aquí abajo tienen que ser comprados en una tienda especializada:

- fijador químico de inyección, mod. Fischer FIP 16
- tornillo exagonal M 6x20 din 931 CNS

Apto para la fijación a las siguientes paredes:

- ladrillos huecos
- ladrillos de aglomerado pre-comprimido
- ladrillos llenos

Ⓛ СПЕЦИАЛЬНЫЙ КРЕПЕЖ

Перечисленные ниже принадлежности должны быть приобретены в специализированном магазине:

- химический впрыскиваемый закрепитель, мод. Fischer FIP 16
- шестигранный винт M 6x20 din 931 CNS

подходит для фиксации на следующие стены:

- полнотелые кирпичи
- кирпичи из восстановленного агломерата
- дырчатые кирпичи

4800

60 x 18 x 70 cm

**Specchio basculante infrangibile
in resine termoplastiche/nylon**

Shatterproof tilting mirror in thermoplastic resins/nylon

Miroir basculant infrangible en thermoplastique/nylon

Neigbarer bruchsicherer Spiegel aus Kunststoff/nylon

Espejo basculante irrompible de resinas termoplásticas/nylon

Поворотное зеркало небьющееся

из термопластичных смол и нейлона

non certificato TÜV - Not TÜV certified - non certifié TÜV

Nicht TÜV-geprüft - no certificado TÜV

испытания на соответствие нормативу TÜV не проводились

4942

23 x 13 x 7 cm



CE

IP 23

W75 - R75

**Lampada alogena per specchio 4800
ottone/vetro/resine termoplastiche**Lamp with halogen light for mirror 4800
brass/glass/thermoplastic resinsApplique avec lampe halogène pour miroir 4800
laiton/verre/thermoplastiqueLeuchte mit Halogenlampe für Spiegel 4800
Messing/Glas/KunststoffAplique con lámpara para espejo 4800
latón/cristal/resinas termoplásticasЧниверсальная галотенная лаппа для зеркал 4800
латунь/стекло/ термопластичная смоль

4840/25*

A 25 cm
30 x 9 x 8 cm

4840/45

A 45 cm
53 x 9 x 8 cm

4841/55

A 55 cm
63 x 9 x 8 cm

4842/65

A 65 cm
73 x 9 x 8 cm

Maniglioni antiscivolo, con superfici prive di angoli -
Non-slip handles, with smooth, rounded surfaces - Poignées
antidérapantes, avec surfaces sans arêtes - Elemente
mit rutschfesten Griffen und kantenlosen Oberflächen
Grilletes antideslizantes, con superficies sin ángulos -
Нескользкие поручни с округлой поверхностью

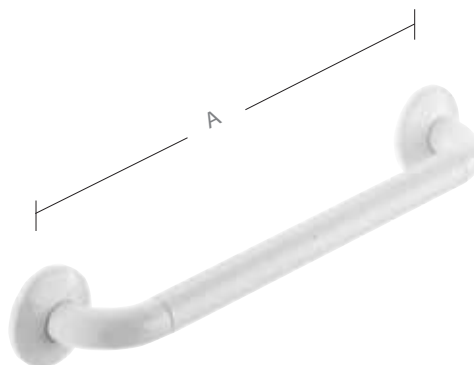

* Articolo disponibile su richiesta - Item available on request
Article disponible sur demande - Auf Anfrage erhältlich Artikel
Artículo disponible bajo petición - Продукция, изготавливаемая
по заказу

4843/10

A 105 cm

113 x 9 x 8 cm

4844/11 *

A 115 cm

123 x 9 x 8 cm



4848/44

A 45,5 cm

B 60,5 cm

52 x 9 x 67 cm

4849/44 *

A 45,5 cm

B 70,5 cm

52 x 9 x 77 cm

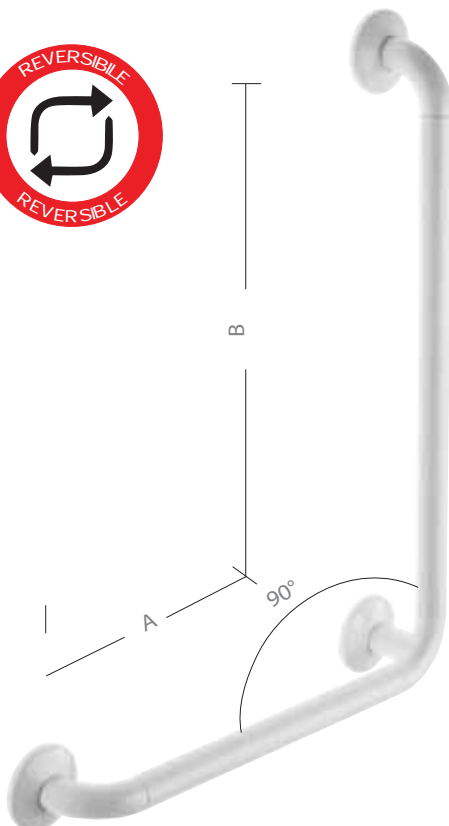

* Articolo disponibile su richiesta - Item available on request
 Article disponible sur demande - Auf Anfrage erhältlich Artikel
 Artículo disponible bajo petición - Продукция, изготавливаемая по заказу

4854/77*

A 77 cm

B 77 cm

81 x 81 x 9 cm

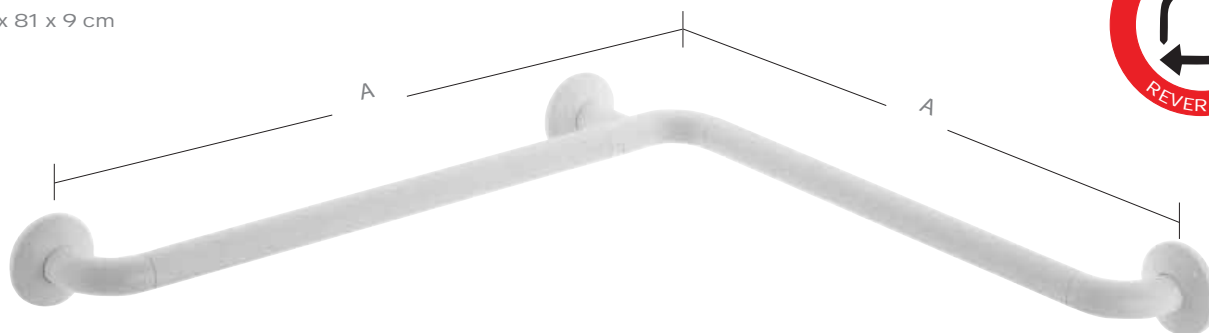
**4857/64**

A 64 x 9 x 18 cm

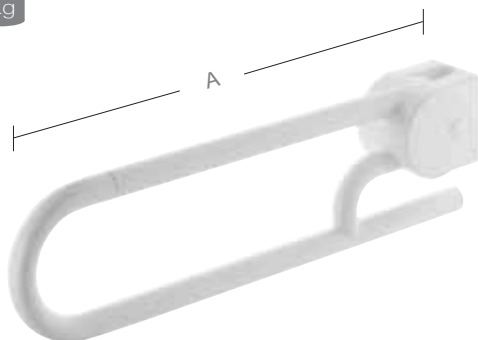
**4858/74**

A 74 x 9 x 18 cm

4859/64

A 64 x 24 x 18 cm

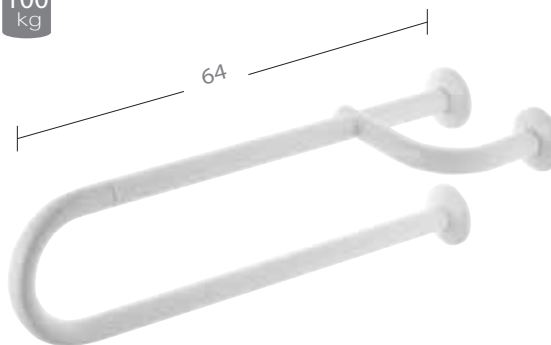
**Meccanismo di ribaltamento in posizione orizzontale e verticale**

Collapsible mechanism in horizontal and vertical position

Mécánisme de basculement en position horizontale et verticale

Kippmechanismus in waagerechter und in senkrechter Position

Mecanismo de abatimiento en posición horizontal y vertical

Откидной механизм в вертикальном и горизонтальном положении

Reversibile

Reversible

Réversible

Reversibler

Reversible

Обратимый

* Articolo disponibile su richiesta - Item available on request
 Article disponible sur demande - Auf Anfrage erhältlich Artikel
 Artículo disponible bajo petición - Продукция, изготавливаемая по заказу

4863 *

23 x 14,5 x 60,5 cm

**Maniglione per vasca. Adattabile a vasche con bordo da 6 cm a 12,5 cm**

Safety handle for bath. Adaptable for bath-tubs with rims from 6 cm to 12,5 cm

Barre de sûreté pour baignoire. Adaptable à baignoires avec bord de 6 cm à 12,5 cm

Wanneneinsteighilfe. Verwendbar für Wannen mit einer Wandstärke von 6 cm bis 12,5 cm

Asidero para bañera. Adaptable a bañeras con borde de 6 cm a 12,5 cm

Двойной поручень на ванну. Устанавливается на ванны, имеющие стенку от 6 до 12,5 см

4880

9 x 9 x 8 cm

Angolo 90°

Angle 90° - Angle 90°

Winkel 90° - Angulo 90°

Угол 90°

**4881**

11 x 9 x 8 cm

Angolo a T

T-Angle - Angle a T

T-Winkel - Angulo a T

Угол в форме T

**4882**

13 x 9 x 9 cm

Angolo 145° con piede

Angle 145° with foot

Angle 145° avec pied

Winkel 145° mit Fuß

Angulo 145° con patas

Угол 145° с ножкой

**4883**

15 x 9 x 9 cm

Angolo 90° con piede

Angle 90° with foot

Angle 90° avec pied

Winkel 90° mit Fuß

Angulo 90° con patas

Угол 90° с ножкой

**4884**

15 x 9 x 8 cm

Supporto con angolo 90°

Support with angle 90°

Support avec angle 90°

Befestigung mit Winkel 90°

Soporte con angulo 90°

Опора с углом 90°



4885 35

4885 45

4885 50

4885 55

4885 60

A 35 cm

A 45 cm

A 50 cm

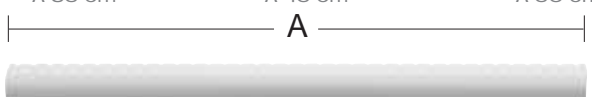

A 55 cm

A 60 cm

Profilo anatomico - Profile tube with finger groove

Profil anatomique - Profilrohr mit Fingerrillen

Perfil aluminio con antideslizante - Анатомический профиль

① Non certificato TÜV - Not TÜV certified - Non certifié TÜV
Nicht TÜV-geprüft - No certificado TÜV - Испытания
на соответствие нормативу TÜV не проводились

2283

34,5 x 34,5 x 10,5 cm

100
kg

**Sedile ribaltabile per doccia
resine termoplastiche/alluminio**

Shower seat - thermoplastic resins/aluminium
Siège pour douche repliable - thermoplastique/aluminium
Duschsitz hochklappbar - Kunststoff/Aluminium
Asiento móvil para ducha - resinas termoplásticas/aluminio
Сиденье для душа - термопластичные смолы/алюминий

2284 ①

64 x 32,4 x 18,3 cm

100
kg

CE

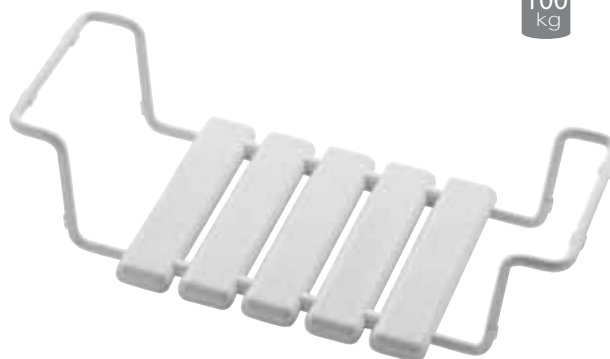

**Sedile estensibile per vasca
resine termoplastiche/alluminio**

Bath tub seat - thermoplastic resins/aluminium
Siège pour baignoire - thermoplastique/aluminium
Badewannensitz - Kunststoff/Aluminium
Asiento para bañera - resinas termoplásticas/aluminio
Раскладное сиденье для ванной
термопластичные смолы/алюминий

Braccioli estensibili per vasche con misura interna di 50-65 cm
Extendable arms for baths with internal measurement 50-65 cm
Bras extensibles pour baignoires aux dimensions intérieures de 50-65 cm
Verlängerbare Armlehnen für Wannen mit einem Innenmaß von 50-65 cm
Aroyabrazos extensibles para bañeras con medidas interiores de 50-65 cm
Выдвижные поручни для ванны, имеющей внутреннюю ширину от
50 до 65 см

4896* ①

43,8 x 51,4 x 60,1 cm

150
kg

Sedile con seduta liscia ergonomica agganciabile a maniglione

Hanging smooth shower seat for grab bar system
Siège pour douche avec assise lisse, accrochable à barre d'appui
Einhängesitz für Griffsystem mit glatter Sitzfläche
Asiento colgado para ducha con silla lisa ergonómica por el sistema de
asideros
Сиденье с гладкой поверхностью, прицепляемое к рукоятке

* Articolo disponibile su richiesta - Item available on request
Article disponible sur demande - Auf Anfrage erhältlicher Artikel
Artículo disponible bajo petición - Продукция, изготавливаемая по заказу

Programma di maniglioni e sistemi d'appoggio fissi e mobili realizzato in acciaio zincato con verniciatura con polveri speciali in resine epossidiche e poliestere e attacchi in Ultraform®.

Range of handles and fixed and movable supporting systems made of zincated steel with covering treated with special epoxy and polyester resins and wall plates in Ultraform®.

Programme de poignées et de systèmes d'appui fixes et mobiles, réalisé en acier zingué avec laquage traité avec des poudres spéciales en résines époxy et polyester et plaques à mur en Ultraform®.

Serie von Griffen, sowie festen und mobilen Stützsystemen, hergestellt aus mit Spezialpulver aus Epoxyd- und Polyesterharzen oberflächenbehandeltem verzinkten Stahl mit Wandbefestigungen aus Ultraform®.

Programa de grilletes y de sistemas de apoyo fijos y de muebles realizado en acero galvanizado con revestimiento tratado con polvos especiales de resinas epoxídicas y poliéster y placas de pared en Ultraform®.

Ассортимент поручней и опорных приспособлений, как съёмных, так и стационарных, изготовлено из оцинковыванной стали, а также покрытия, обработанные специальными эпоксидными и полиэфирными порошками и с плитами стены в Ultraform®.



**6421/30**

37,5 x 11 x 7,5 cm - A=30

6421/45

52,5 x 11 x 7,5 cm - A=45

6421/60

67,5 x 11 x 7,5 cm - A=60

6421/90

97,5 x 11 x 7,5 cm - A=90

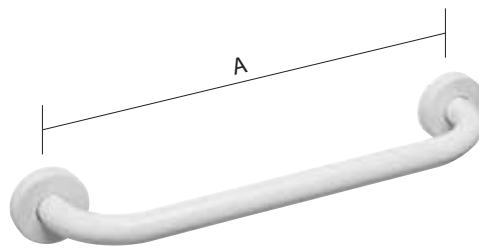
**6490/00**

A 36 x B 65 x 11 cm

6490/01

A 36 x B 65 x 11 cm

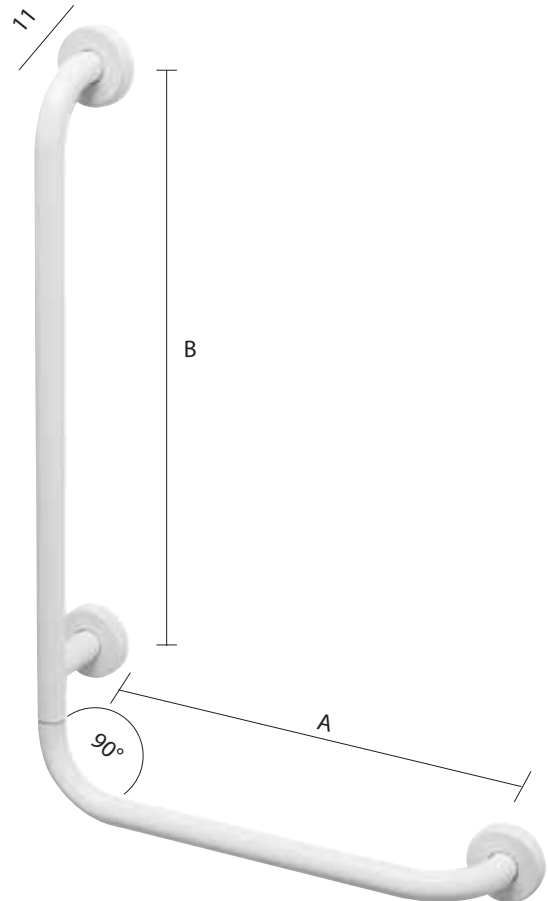
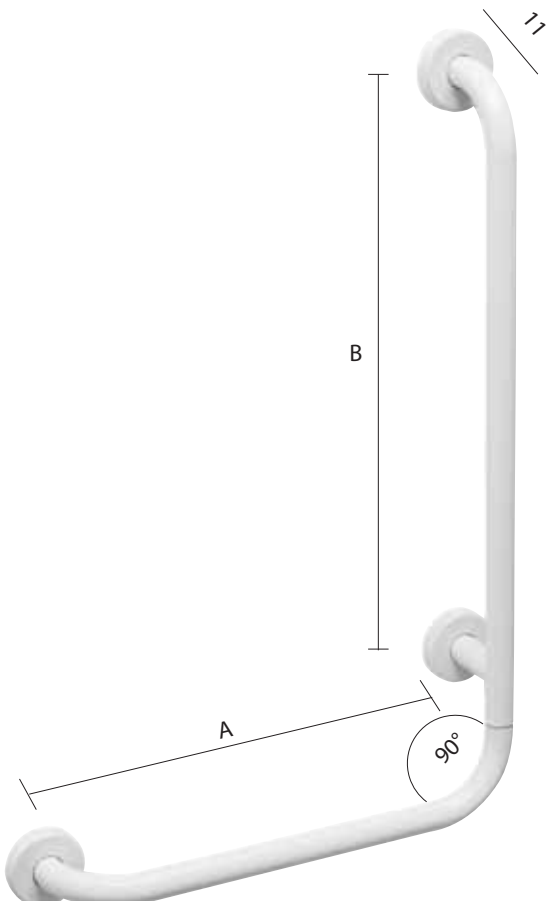

6445

58,5 x 11 x 39 cm

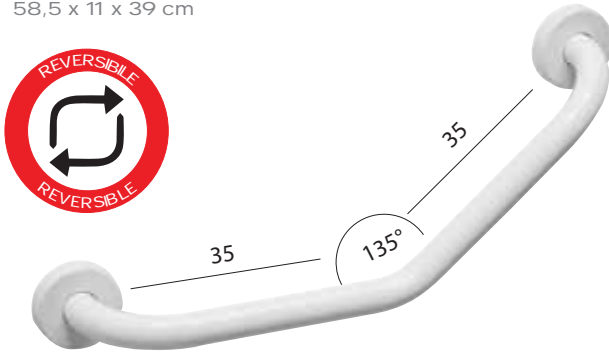

6450

7,5 x 16,5 x 187,5 cm



6466*

8,5 x 67 x 25 cm

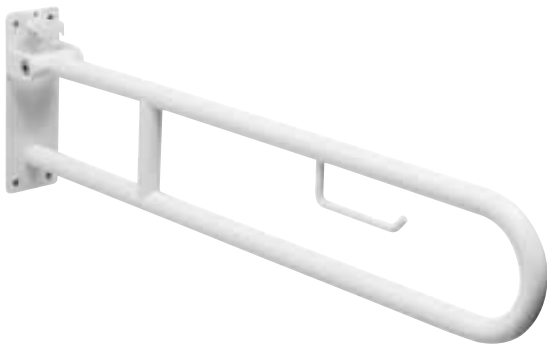

6465*

8,5 x 67 x 25 cm

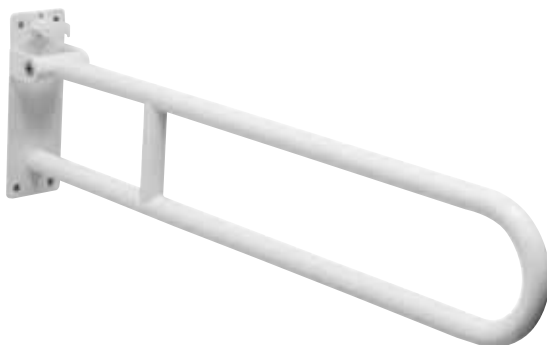

* Meccanismo di ribaltamento in posizione orizzontale e verticale

Collapsible mechanism in horizontal and vertical position

Mécanisme de basculement en position horizontale et verticale

Kippmechanismus in waagerechter und in senkrechter Position

Mecanismo de abatimiento en posición horizontal y vertical

Откидной механизм в вертикальном и горизонтальном положении



Gedy S.p.A.
Via dell'Industria, 6
21040 Origgio (VA) - Italia
Tel. +39.02.96.95.01
Fax +39.02.96.73.43.01
www.gedy.com - info@gedy.com

